

marantz®

Model SA-17S1 User Guide

Super Audio CD Player

CLASS 1 LASER PRODUCT
LUOKAN 1 LASERLAITE
KLASS 1 LASERAPPARAT



Stereo
Multi-ch

COMPACT
disc
DIGITAL AUDIO
TEXT

ENGLISH

WARRANTY

For warranty information, contact your local Marantz distributor.

RETAIN YOUR PURCHASE RECEIPT

Your purchase receipt is your permanent record of a valuable purchase. It should be kept in a safe place to be referred to as necessary for insurance purposes or when corresponding with Marantz.

IMPORTANT

When seeking warranty service, it is the responsibility of the consumer to establish proof and date of purchase. Your purchase receipt or invoice is adequate for such proof.

FOR U.K. ONLY

This undertaking is in addition to a consumer's statutory rights and does not affect those rights in any way.

FRANÇAIS

GARANTIE

Pour des informations sur la garantie, contacter le distributeur local Marantz.

CONSERVER L'ATTESTATION D'ACHAT

L'attestation d'achat est la preuve permanente d'un achat de valeur. La conserver en lieu sûr pour s'y reporter aux fins d'obtention d'une couverture d'assurance ou dans le cadre de correspondances avec Marantz.

IMPORTANT

Pour l'obtention d'un service couvert par la garantie, il incombe au client d'établir la preuve de l'achat et d'en corroborer la date. Le reçu ou la facture constituent des preuves suffisantes.

DEUTSCH

GARANTIE

Bei Garantiefragen wenden Sie sich bitte an Ihren Marantz-Händler.

HEBEN SIE IHRE QUITTING GUT AUF

Die Quittung dient Ihnen als bleibende Unterlage für Ihren wertvollen Einkauf. Das Aufbewahren der Quittung ist wichtig, da die darin enthaltenen Angaben für Versicherungszwecke oder bei Korrespondenz mit Marantz angeführt werden müssen.

WICHTIG!

Bei Garantiefragen muß der Kunde eine Kaufunterlage mit Kaufdatum vorlegen. Ihren Quittung oder Rechnung ist als Unterlage ausreichend.

NEDERLANDS

GARANTIE

Voor inlichtingen omtrent garantie dient u zich tot uw plaatselijke Marantz.

UW KWITANTIE, KASSABON E.D. BEWAREN

Uw kwitantie, kassabon e.d. vormen uw bewijs van aankoop van een waardevol artikel en dienen op een veilige plaats bewaard te worden voor evt. verwijzing bijv. in verband met verzekering of bij correspondentie met Marantz.

BELANGRIJK

Bij een evt. beroep op de garantie is het de verantwoordelijkheid van de consument een gedateerd bewijs van aankoop te tonen. Uw kassabon of factuur zijn voldoende bewijs.

ESPAÑOL

GARANTIA

Para obtener información acerca de la garantía póngase en contacto con su distribuidor Marantz.

GUARDE SU RECIBO DE COMPRA

Su recibo de compra es su prueba permanente de haber adquirido un aparato de valor. Este recibo deberá guardarlo en un lugar seguro y utilizarlo como referencia cuando tenga que hacer uso del seguro o se ponga en contacto con Marantz.

IMPORTANTE

Cuando solicite el servicio otorgado por la garantía el usuario tiene la responsabilidad de demostrar cuándo efectuó la compra. En este caso, su recibo de compra será la prueba apropiada.

ITALIANO

GARANZIA

L'apparecchio è coperto da una garanzia di buon funzionamento della durata di un anno, o del periodo previsto dalla legge, a partire dalla data di acquisto comprovata da un documento attestante il nominativo del Rivenditore e la data di vendita. La garanzia sarà prestata con la sostituzione o la riparazione gratuita delle parti difettose.

Non sono coperti da garanzia difetti derivanti da uso improprio, errata installazione, manutenzione effettuata da personale non autorizzato o, comunque, da circostanze che non possano riferirsi a difetti di funzionamento dell'apparecchio. Sono inoltre esclusi dalla garanzia gli interventi inerenti l'installazione e l'allacciamento agli impianti di alimentazione.

Gli apparecchi verranno riparati presso i nostri Centri di Assistenza Autorizzati. Le spese ed i rischi di trasporto sono a carico del cliente.

La casa costruttrice declina ogni responsabilità per danni diretti o indiretti provocati dalla inosservanza delle prescrizioni di installazione, uso e manutenzione dettagliate nel presente manuale o per guasti dovuti ad uso continuato a fini professionali.

PORTUGUÊS

GARANTIA

Para informações sobre a garantia, contactar o distribuidor Marantz local.

GUARDAR O RECIBO DE COMPRA

O recibo é o registo permanente da compra que fez. Deve ser guardado num local seguro, para ser apresentado em questões relacionadas com o seguro ou para quando tiver de contactar a Marantz.

IMPORTANTE

Quando procurar assistência técnica ao abrigo da garantia, é da responsabilidade do consumidor estabelecer a prova e data de compra. O recibo é prova adequada.

SVENSKA

GARANTI

För information om garantin, kontakta Marantz lokalagent.

SPAR KVITTOT

Kvittot är ett inköpsbevis på en värdefull vara. Det skall förvaras säkert och hänvisas till vid försäkringsfall eller vidkorrespondens med Marantz.

VIKTIGT

Fö att garantin skall gälla är det kundens sak att framställa bevis och datum om köpet. Kvitto eller faktura är tillräckligt bevis för detta.

DANSK

GARANTI

Henvend dem til Deres MARANTZ-forhandler angående information om garantien.

GEM DERES KVITTERING

Deres købskvittering er Deres varige bevis på et dyrt køb. Den bør gemmes godt og anvendes som bevis, hvis De vil tegne en forsikring, eller hvis De kommunikerer med Marantz.

VIGTIGT

Det påhviler forbrugeren at skaffe bevis for købet og købsdatoen, hvis han eller hun ønsker garantiservice. Deres købskvittering eller faktura er et fuldgældigt bevis herpå.

FOREWORD

This section must be read before any connection is made to the mains supply.

WARNINGS

- Do not expose the equipment to rain or moisture.
- Do not remove the cover from the equipment.
- Do not insert anything into the equipment through the ventilation holes.
- Do not handle the mains lead with wet hands.
- Do not cover the ventilation with any items such as tablecloths, newspapers, curtains, etc.
- No naked flame sources, such as lighted candles, should be placed on the equipment.
- When disposing of used batteries, please comply with governmental regulations or environmental public instruction's rules that apply in your country or area.

CE marking

CE The SA-17S1 conforms with the EMC directive and low-voltage directive.

EQUIPMENT MAINS WORKING SETTING

Your Marantz product has been prepared to comply with the household power and safety requirements that exist in your area. This product can be powered by 230 V AC only.

COPYRIGHT

Recording and playback of any material may require consent. For further information refer to the following:

- Copyright Act 1956
- Dramatic and Musical Performers Act 1958
- Performers Protection Acts 1963 and 1972
- any subsequent statutory enactments and orders

INTRODUCTION

Thank you for selecting the Marantz SA-17S1 Super Audio CD Player for your A / V system.

This Player incorporates a number of features designed to enhance the listening of your favorite audio sources.

Please read these operating instructions carefully. We recommend that you read the entire user guide before you attempt to connect or operate the player.

After you have reviewed the contents of this manual, we suggest that you make all system connections before you attempt to operate the unit.

Refer to the figures on the pages at the back of this user's guide. The callout numbers on the figures correspond to those found in the text.

INSTALLATION

Remember the following important points when installing the player:

- Do not expose the player to rain or moisture, as this may cause damage to the player.
- All players produce some heat during operation and this heat must be allowed to disperse freely. Do not close any ventilation openings and insure that there is adequate ventilation space behind, beside and above the player.
- Prevent extra heat from reaching the unit. Never put the player in the full glare of the sun or near a heat source.

PRECAUTIONS

The following precautions should be taken when operating the equipment.

GENERAL PRECAUTIONS

When installing the equipment ensure that:

- the ventilation holes are not covered.
- air is allowed to circulate freely around the equipment.
- it is placed on a vibration-free surface.
- it will not be exposed to excessive heat, cold, moisture or dust.
- it will not be exposed to direct sunlight.
- it will not be exposed to electrostatic discharges.

In addition, never place heavy objects on the equipment.

If a foreign object or water does enter the equipment, contact your nearest dealer or service center.

Do not pull out the plug by pulling on the mains lead; grasp the plug. It is advisable when leaving the house for an extended period, or during a thunderstorm, to disconnect the equipment from the mains supply.

PRECAUTIONS IN CONNECTION

- Be sure to unplug the power cable from the AC outlet or turn off the POWER switch before proceeding with any connection.
- Connect one cable at a time observing the "input" and "output". This will avoid any cross connection between channels and signal inputs and outputs.
- Insert the plugs securely. Incomplete connection may result in noise.
- Prior to connecting other audio and video equipment to the SA-17S1, please read their owner's manuals.

TABLE OF CONTENTS

BEFORE USING	3
Notes about the discs	3
Inappropriate places for installation	3
Do not place objects on top	3
Cautions on handling power cord	3
Do not attempt repairs yourself.....	4
Precautions	4
Cautions on handling batteries	4
INTRODUCTION	5
About super audio	5
Playing CD-RW discs	5
Applicable Discs to the Unit	5
FEATURES	6
ACCESSORIES	7
Checking the accessories	7
Usage of REMOTE CONTROL UNIT	7
NAMES AND FUNCTIONS	8
Front panel.....	8
Display	9
Remote control unit.....	10
Rear panel	11
CONNECTIONS	12
Connecting the player to a 2-channel stereo amplifier or AV amplifier	12
Connecting the player to an analog multi-channel amplifier or AV amplifier	13
Connections when the phantom center function is to be used	14
Installing the SACD multi-channel audio speakers	15
OPERATION	16
Preparing for disc play	16
Disc play	16
Switching Sound Mode (SACD).....	17
Start sound mode	17
Phantom center function.....	17
Playing your favorite tracks of a disc	18
Repeated disc play (Repeat Play)	18
Playing tracks in a random sequence (Random Play)	19
Playing tracks in a specific sequence (Program Play)	19
Searching your favorite tracks (AMS (Automatic Music Scan) Play)	20
About TEXT Information Display	21
About TEXT	21
Timer Play	22
Filter Switch	22
TROUBLE SHOOTING	23

BEFORE USING

Notes about the discs

* **Handle the discs carefully so as not to scratch their surfaces.**

* **Keep the surfaces of the discs clean at all times.**

When cleaning the surfaces of discs, always be sure to use the special cleaner and wipe the surfaces in the directions shown in the figure below.

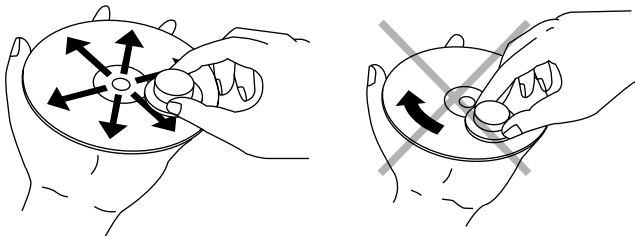

- Wipe the surface radially from the center.
- Do not wipe the surface in the circumferential direction.

* **Do not attach pieces of paper or stickers to the label surfaces of the discs.**

When a disc has a piece of plastic tape or rental CD label with paste protruding from the edge or when a disc still bears traces of sticky tape or adhesive labels, do not attempt to play it. If such a disc is played on the CD player, you may find that you cannot remove it or that some other kind of malfunctioning may occur.

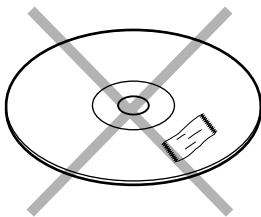

* **Do not use discs which come in special shapes.**

Do not attempt to play heart-shaped or octagonal discs or discs with any other special shapes. You may find that you cannot remove them or that some other kind of malfunctioning may occur in the player.

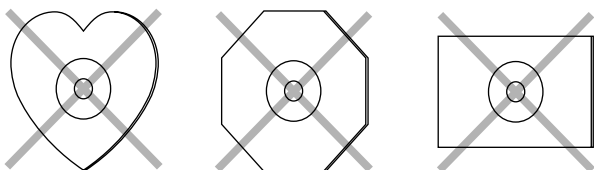

* **Use discs which satisfy the CD standards such as those with the "CD logo" or "compact disc" mark on their disc label surfaces.**

No guarantees are made for playback if discs which do not satisfy the appropriate CD standards are used.

Similarly, no guarantees are made for their sound quality even if it is possible to play such discs.

* **To protect your discs from damage, avoid placing them in the following locations.**

- Where they will be exposed to direct sunlight or where they will be close to a heater or other heat-radiating appliance
- Where the humidity level is high or it is very dusty
- Near a window or other such location where they may be exposed to rain

* **Get into the habit of putting the discs back in their cases after use.**

Inappropriate places for installation

To keep your player in perfect working order for the longest possible time, avoid installing the player in the following locations.

- Wherever it will be exposed to direct sunlight
- Wherever it will be close to a heater or other heat-radiating appliance
- Wherever the humidity is high or ventilation is poor
- Wherever it is very dusty
- Wherever it will be subject to vibration
- On top of a rickety stand or in an unstable location which is tilted at an angle
- On top of an amplifier or other component which dissipates a great deal of heat
- In an audio rack with little space at the top and bottom or other location where the heat dissipation will be obstructed

To ensure proper heat dissipation, install the player while leaving clearances between the player and wall or other components, as shown in the figure below.

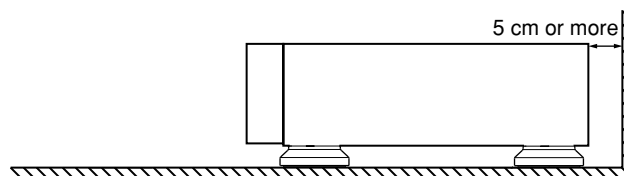
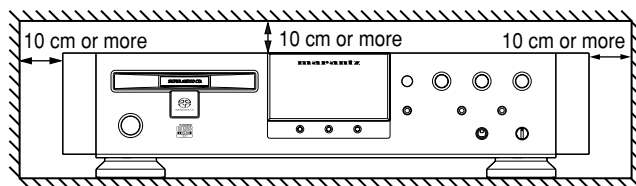

Do not place objects on top

- Refrain from placing any objects on top of the player.

Cautions on handling power cord

- Do not touch the power cord with wet hands.
- When disconnecting the power cord, always make sure that you take hold of the plug. Yanking out or bending the cord can damage it and/or cause electric shocks or a fire.
- Get into the habit of disconnecting the power plug before leaving home.

Do not attempt repairs yourself

- Refrain from lubricating the player: doing so can cause malfunctioning.
- Only qualified engineers with specialized expertise are authorized to repair the pick-up and parts inside the player.

Precautions

- In winter, droplets of water form on the insides of the windows of a heated room: this is called condensation. This player uses an optical lens, so the condensation may form in the following cases.
 - In a room immediately after the heating has been turned on
 - In a room where the humidity level is high
 - When the player has been suddenly brought from a cold location into a warm roomSince, in cases like this, the track numbers may not be read and the player is prevented from operating properly, wait about 30 minutes, and then operate the player.
- This player may cause interference on a tuner or TV set. If this is the case, place it further away from the tuner or TV set.
- Compact discs have much less noise than analog records and hardly any noise is heard before play starts. Bear in mind, therefore, that if the volume control on the amplifier is set too high, you will risk damaging other audio components.
- This player is designed to play music CDs only. It cannot play CD-ROMs used with personal computers, game CDs, video CDs or DVDs (video/audio).

Cautions on handling batteries

Misuse of the batteries can result in electrolyte leakage, rupturing, corrosion, etc.

Bear in mind the following points when using batteries.

- Remove the batteries from the remote control unit if the unit is not going to be used for a prolonged period (a month or more).
- Do not use an old battery together with a new one.
- Insert the batteries while ensuring that their \oplus and \ominus poles are properly aligned with the corresponding markings on the remote control unit.
- Batteries with the same shape may have different voltages. Do not use different types of batteries together.
- If electrolyte has leaked, thoroughly wipe the inside of the battery compartment, and then insert new batteries.
- When batteries which are no longer required are to be discarded, follow the directions (regulations) laid down by the local authorities in the area concerned for their disposal.

INTRODUCTION

About super audio

The Super Audio standard is based on Direct Stream Digital (DSD) technology. This new direct-stream digital format comprises a 1-bit system that has a digital sampling frequency that is 64 times higher than that of conventional audio CD. The results are spectacular: a frequency response of over 50k Hz and a 120 dB dynamic range over the entire audible spectrum. Mixed with as many of the original frequencies as possible, the audio information audible for human ears sounds much more natural.

All audible frequencies are, after all, embedded in the frequency range as emitted by the sound source. A better reproduction does not exist! For the first time your ears will relive reality.

The latest information on the software and other aspects of SACD can be accessed over the Internet.

<http://www.super-audiocd.com>

Playing CD-RW discs

This unit can play back the CD-RW (ReWritable) discs as well as ordinary music CD and CD-R (Recordable) discs.

- The CD-R and CD-RW discs should contain properly-recorded TOC information so that they can be played back. With the CD recorder system, writing the TOC information in a disc is referred to as finalizing the disc. A disc cannot be recognized as a CD disc and played back unless it has been finalized properly. For details, please read the instruction manual provided with a CD recorder.
* TOC stands for Table Of Contents and contains information such as the total number of tracks and total playing time of the disc.
- This unit can play only the discs recorded in the CD-DA format designed for music reproduction. Do not attempt to play a disc containing other data, such as a CD-ROM for PCs, on this unit.
- As the playback of a CD-RW disc necessitates partial change of the player setup, it may take longer time for reading the TOC information than when a music CD or CD-R disc is played.

Applicable Discs to the Unit

1. Super Audio CD



Stereo Multi-ch

There are three types of Super Audio CDs.

- Single-layer Disc
- Dual-layer Disc
- Hybrid-layer Disc

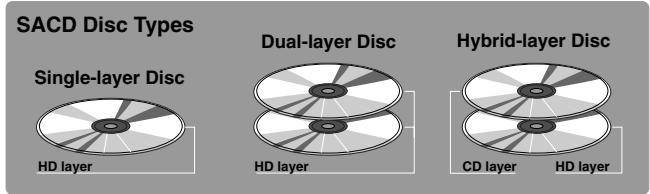



And each type may contain two areas of recorded information.

- High quality stereo area
- High quality multi-channel area

- **Single Layer Disc**
It can contain both high quality stereo area and high quality multi-channel area information.
- **Dual Layer Disc**
It can contain both high quality stereo area and high quality multi-channel area information. And a double amount of information can be stored on the disc thanks to the second layer.
- **Hybrid Layer Disc**
The hybrid disc may contain not only both information areas but also a second, standard CD layer, making it playable on standard CD players.

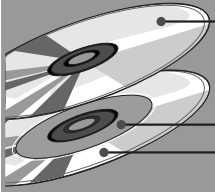
Hybrid SACD-Disc



- 1 **CD layer that plays on any of your existing CD players**
- 2 **High-Density layer containing:**
 - High-Quality DSD Stereo
 - 3 - High-Quality DSD Multi-channel

The number of tracks recorded may vary per layer. It will be shown on the display window of the unit.

2. Audio CD (CDDA)



Audio CDs contain music tracks only.

FEATURES

Super Audio CD multi-channel player

“Reproducing the acoustics of the concert hall in your own room”

The Super Audio CD (SACD) multi-channel format is the fulfillment of what audiophiles have dreamed of for many years. Through a multiple number of speakers placed around the listener, it enables sound to be reproduced with the authentic acoustics of the hall or performers’ stage with all the impressions of its real-life dimensions.

“Conjuring up the acoustics of a concert hall within the confines of the listening room”

The <SA-17S1> SACD multi-channel player enables you to experience through the very fibers of your body the excellent quality of the SACD multi-channel format.

Multi-channel audio circuits, complete with current feedback HDAM and structured identically for all 6 channels

Current feedback-type HDAMs (high-speed voltage amplification modules which are the result of yet another Marantz original breakthrough) are used for all six audio output channels. The discretely configured current feedback amplifier is also employed in the filter amplifier to help ensure that the vast amounts of high-density music information recorded on the SACDs are reproduced faithfully by wide-band/high-speed circuit technology.

Copper plates have been added to the bases of the multi-channel output connectors to achieve zero ground impedance between the connectors.

As a result, the ground potential of all six channels is fixed in one point, and authentic multi-channel acoustics are spirited up with nothing withheld in this department.

SACD-DACs made by Cirrus Logic, Inc. featured to ensure that the SACD and CD sound is reproduced with a high sound quality

The player incorporates three CS4397 D/A converters (made by Cirrus Logic, Inc.) developed for use with SACDs and CDs to achieve full drive for all six channels.

- When an SACD is played
The DSD signals recorded on the SACD are directly connected to the multi-element switched capacitors (24 elements) with low jitter characteristics in the last stage of the CS4397 SACD D/A converters, and they are converted into extremely accurate analog signals.
- When a conventional CD is played
The PCM signals recorded on the CD are processed by 128x oversampling inside the CS4397 SACD D/A converters and, by means of a combination of the dynamic element matching (DEM) and multi-element switched capacitors, they are converted into very accurate analog signals with a high linearity.

Mechanism module exclusively designed for SACD/CD audio

The mechanism module developed by Marantz uses a circuit board to reduce the noise generated from the digital circuits to the lowest level possible, and its stable reproduction capability ensures that SACDs and CDs are played with a high sound quality.

Power supply circuit for high-quality SACD play

- “Super ring” (toroidal transformer) used
The player features a powerful power supply section that contains a “super ring” (toroidal transformer) with a high efficiency and minimal leakage flux. Also featured is a special power transformer for the display tube to yield a stable power supply and shut out noise.
- Original audio-use capacitors adopted
Capacitors specially designed for audio applications with a high sound quality and large capacity are used in the power supply block. They were created through a process of repeated prototype production and test listening sessions.
They help to create the “Marantz sound” which is soft, sophisticated and full of acoustic ambience.

Phantom center function makes its debut

If, when you intend to sit back and enjoy SACD multi-channel discs, you cannot find a place for the center speaker because of the conditions prevailing in the operating environment, the sound field at the front will be extended to the left and right and feel unnatural. If the player’s “phantom center function” is used in a situation like this, the center channel sound will be distributed to the front left and right channels, resulting in the synthesis of a virtual center channel. In other words, the function makes it possible to recreate a convincing sound field that has almost the same superb acoustics as what would be reproduced using the center speaker as well.

Headphone output with high sound quality

The headphone output circuit uses a discrete configuration that incorporates a high-speed buffer amplifier with a high drive capability. As a result, you can enjoy the pure sound delivered by SACDs even through your headphones.

LPF (low-pass filter) selector switch provided

Using this LPF switch provided on the rear panel, you can now select either the “CUSTOM” setting (wide-band play for all channels) that fits the bill when listening to sound reproduced by a system that supports SACDs or the “STANDARD” setting when listening to the sound reproduced by a conventional audio system.

Double-layered chassis

The chassis is made of copper-plated steel sheets, and 3.2 mm thick steel sheets (weighing 3.2 kg) are used for the bottom chassis with its double-layered construction. It anchors the SACD mechanism firmly in place and eliminates all vibration. It helps to reproduce a clear sound free from indistinctness.

DISPLAY OFF function

This function slashes the amount of noise emanating from the fluorescent display tube and ensures that it does not affect the reproduced sound.

SACD/CD TEXT display function

This displays the TEXT information that is provided on SACD and CD discs.

ACCESSORIES

Checking the accessories

After opening the cover of the packing box, check that the following accessories are included.

- Remote control unit (RC-17SAS1)

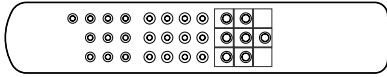

- AAA (R03) Batteries

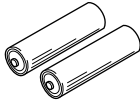

- Power Cord

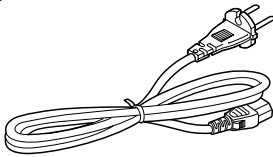

- Audio Cable (1 meter long) 3Pairs

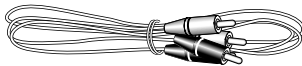

- Remote control connecting cable (90 cm long)

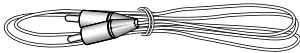

- User Guide

Usage of REMOTE CONTROL UNIT

• Precautions

- Do not allow direct sunlight, an inverter fluorescent light or other strong source of light to shine onto the player's infrared signal reception window (remote sensor). Otherwise, the operation of the remote control unit may be disabled.
- Bear in mind that operating the remote control unit may cause other devices operated by infrared rays to be operated by mistake.
- The remote control unit cannot be operated if the space between the controller and the player's remote sensor is obstructed.
- Do not place any objects on top of the remote control unit. Doing so may cause one or more buttons to be held down which will cause the batteries to run down.

• Loading batteries

Before using the supplied remote control unit for the first time, load the batteries in the remote control unit. The batteries provided are used to verify the operations of the remote control unit only.

- 1 Remove the battery cover which is found on the back side of the remote control unit.

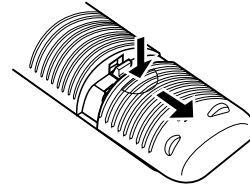

- 2 Load the two new size "AAA" batteries inside the battery compartment while taking care to align their polarities correctly with the polarity markings (+ with + and - with -).

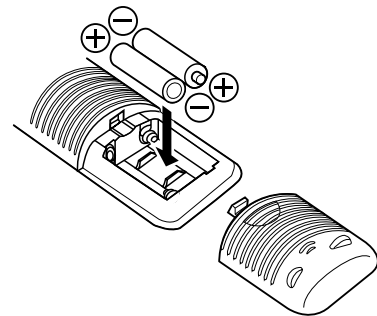

- 3 Push the cover on the back side in the direction of the arrow to close.

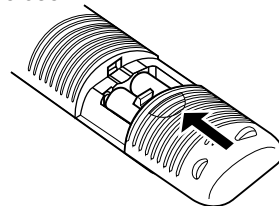

• Operational range

Operate the remote control unit (RC-17SAS1) within a distance of approx. 5 m from the infrared signal reception window (remote sensor) on the front of the SACD player. Remote control operation may not be possible if the remote control unit's transmitter is not pointing in the direction of the remote sensor or if there is an obstruction between the transmitter and the remote sensor.

Remote control operating range

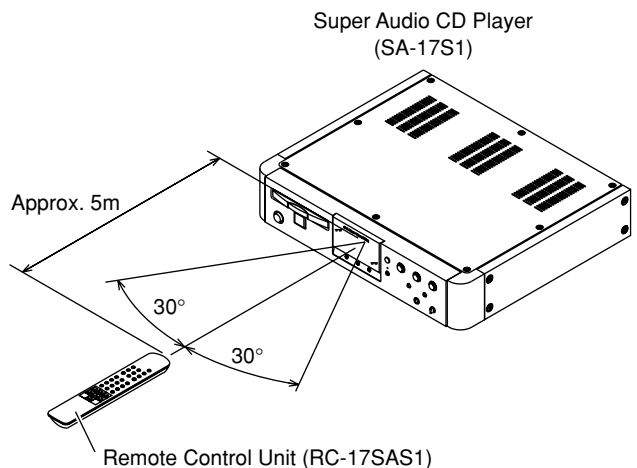

NAMES AND FUNCTIONS

Front panel

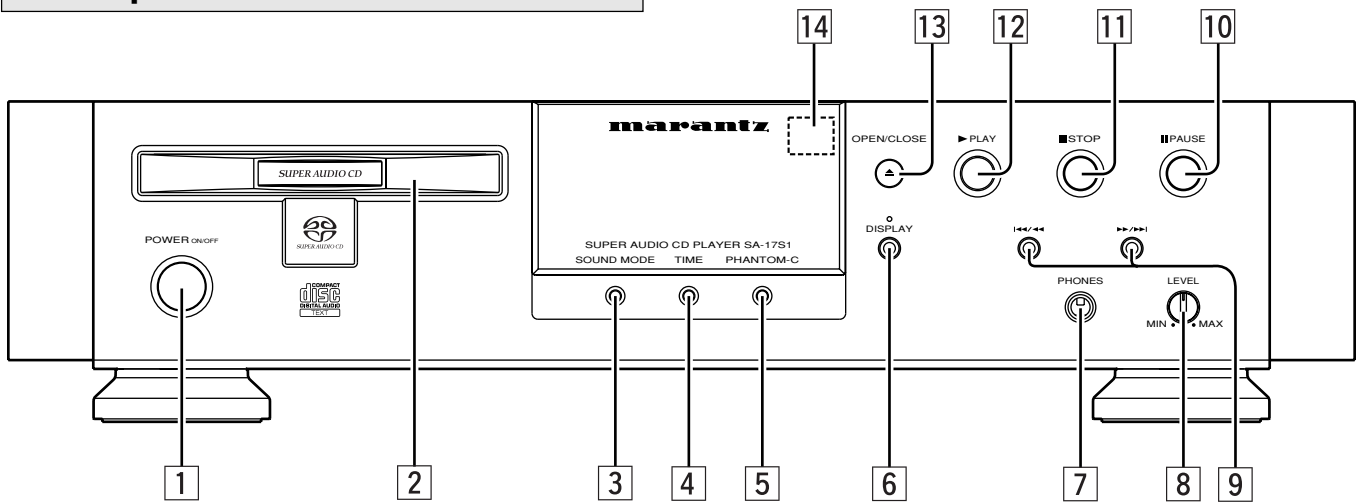

1 POWER ON/OFF switch

This switch is used to turn the power ON and OFF. When it is pressed, the display window lights up, and the power comes on. When it is pressed again, the display window is extinguished, and the power goes off.

2 Disc tray

The disc to be played is placed on the tray.

3 SOUND MODE button

This button is used to select "SACD stereo," "SACD multi-channel" or "CD" (if discs are supported) as the Super Audio CD sound mode. (See page 17)

4 TIME button

This button is used to change the player's display from "text information" to "time information" while a disc that supports TEXT is in use. It is also pressed to switch the time display of the disc being played. (See page 16)

5 PHANTOM-C (phantom center) button

This button is used to select the phantom center function. (See page 17)

6 DISPLAY button and indicator

This button is used to extinguish the display window (DISPLAY OFF). When it is pressed, the display window is extinguished, and the DISPLAY indicator lights. When it is pressed again, the display window lights, and the DISPLAY indicator goes off.

7 PHONES (headphone) jack

The headphones are connected to this jack. Use headphones with a standard plug.

* In the SACD multi-channel mode, the front L and R signals are output.

8 LEVEL (headphone volume) control

This control is used to adjust the headphone volume. Turn it clockwise to increase the headphone volume.

9 <<</>>> (Track Skip/Search buttons)

These buttons can be used as both track skip and track search buttons. (The buttons on the main unit only.)

<<< : When this button is pressed, the unit goes back to the beginning of the current track. If the button is pressed more times, the track being played is skipped back. When this button is held down, tracks are searched backward (Fast Rewind).

>>> : Each time this button is pressed, the track being played is skipped forward. When this button is held down, tracks are searched forward (Fast Forward).

In program play, Fast Forward and Fast Rewind can be done in the playing track only.

10 || PAUSE button

This button is used to pause playback. If pressed again, the unit returns to playback.

11 ■ STOP button

This button is used to stop playback. Also this button is used to clear all programs.

12 ► PLAY button

This button is used to start playback.

13 ▲ OPEN/CLOSE button

This button is used to open the tray. Put on a disk label side up. Press the button again to close the tray.

14 Infrared sensor

The infrared control signals emitted from the remote control unit are sensed here.

Display

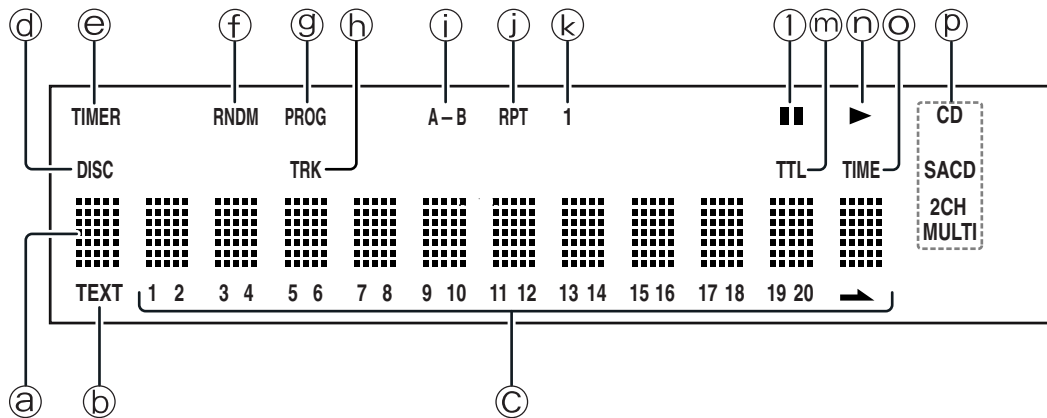

(a) **Main display**

The time display and text information of the disc to be played as well as the setting menus and other displays appear on the main display.

(b) **TEXT indicator**

This lights when a disc supporting TEXT has been inserted.

(c) **1-20, ► (music calendar)**

The number of tracks recorded on the disc to be played, the number of remaining tracks to be played, and the number of tracks programmed by program play appear here. "►" light when 21 or more tracks have been recorded on the disc.

(d) **DISC indicator**

This flashes when the disc's table of contents (TOC) is being read.

(e) **TIMER indicator**

This lights when timer play has been set.

(f) **RNDM (random) indicator**

This lights during random play.

(g) **PROG (program) indicator**

This lights during program play.

(h) **TRK (track) indicator**

This lights above the display of the track number now playing, for instance.

(i) **A-B (A-B repeat) indicator**

This lights during A-B repeat play.

(j) **RPT (repeat) indicator**

This lights during repeat play.

(k) **1 (1-track repeat) indicator**

This lights during 1-track repeat play.

(l) **|| (pause) indicator**

This lights when play is paused (temporarily stopped).

(m) **TTL (total time) indicator**

When the total remaining time or the total program time is displayed, this lights above the display.

(n) **► (play) indicator**

This lights during disc play.

(o) **TIME indicator**

This lights when the elapsed time or other time is displayed.

(p) **Disc indicator**

This indicates the type of disc on the disc tray.

Remote control unit

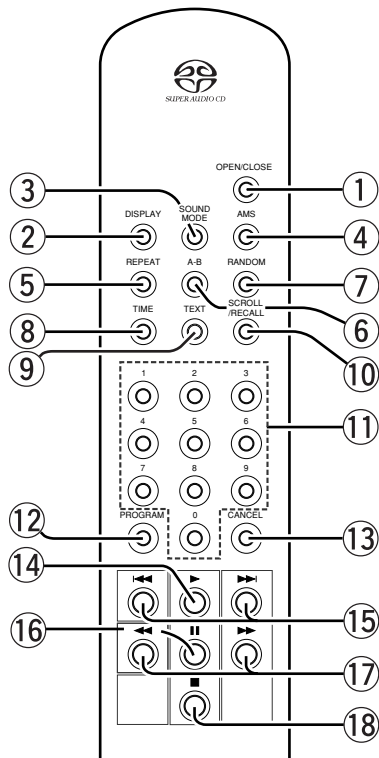

- ① **OPEN/CLOSE button**
This button is used to open or close the disc tray.
- ② **DISPLAY button**
This button is used to turn the display window on or off (DISPLAY OFF).
- ③ **SOUND MODE button**
This button is used to select "SACD stereo," "SACD multi-channel" or "CD" (if discs are supported) as the Super Audio CD sound mode. (See page 17)
- ④ **AMS (auto music scan) button**
This button is used to play just the first 10 seconds of each track on the disc in sequence starting with track 1. (AMS play) (See page 20)
- ⑤ **REPEAT button**
This button is used to repeatedly play one track or all the tracks on the disc. (Repeat play) (See page 18)
- ⑥ **A-B (A-B repeat) button**
This button is used to specify the start point (A) and end point (B) to repeatedly play the desired part specified by these two points. (A-B repeat play) (See page 18)
- ⑦ **RANDOM button**
This button is used to play the tracks on a disc in a random sequence. (Random play) (See page 19)

- ⑧ **TIME button**
This button is used to change the player's display from "text display" to "time display" while a disc that supports TEXT is in use. It is also pressed to switch the time display of the disc being played. (See page 16)
- ⑨ **TEXT button**
When a disc with text is being played, this button changes information displayed from time information to text information.
When a disc without text information is being played, "No Text" will be displayed.
- ⑩ **SCROLL/RECALL button**
This button is used to scroll text while displaying text information in a disc with text.
Also, this button is to check programmed tracks for program play. (See page 20)
- ⑪ **Number (0-9) buttons**
These buttons are used to specify the numbers of the tracks which are to be played.
- ⑫ **PROGRAM button**
This button is used to program play. (See page 19)
- ⑬ **CANCEL button**
This button is used to cancel a programmed track. (See page 20)
- ⑭ **▶ PLAY button**
This button is used to start playback.
- ⑮ **◀◀, ▶▶ (Track skip buttons)**
◀◀ : When this button is pressed, the unit goes back to the beginning of the current track. If the button is pressed more times, the track being played is skipped back.
▶▶ : Each time this button is pressed, the track being played is skipped forward.
- ⑯ **⏸ PAUSE button**
This button is used to pause playback. If pressed again, the unit returns to playback.
- ⑰ **◀◀, ▶▶ (Search buttons)**
◀◀ : While this button is pressed during playback, tracks are searched backward.
▶▶ : While this button is pressed during playback, tracks are searched forward.
In program play, Fast Forward and Fast Rewind can be done in the playing track only.
- ⑱ **■ STOP button**
This button is used to stop playback. Also this button is used to clear all programs.

Rear panel

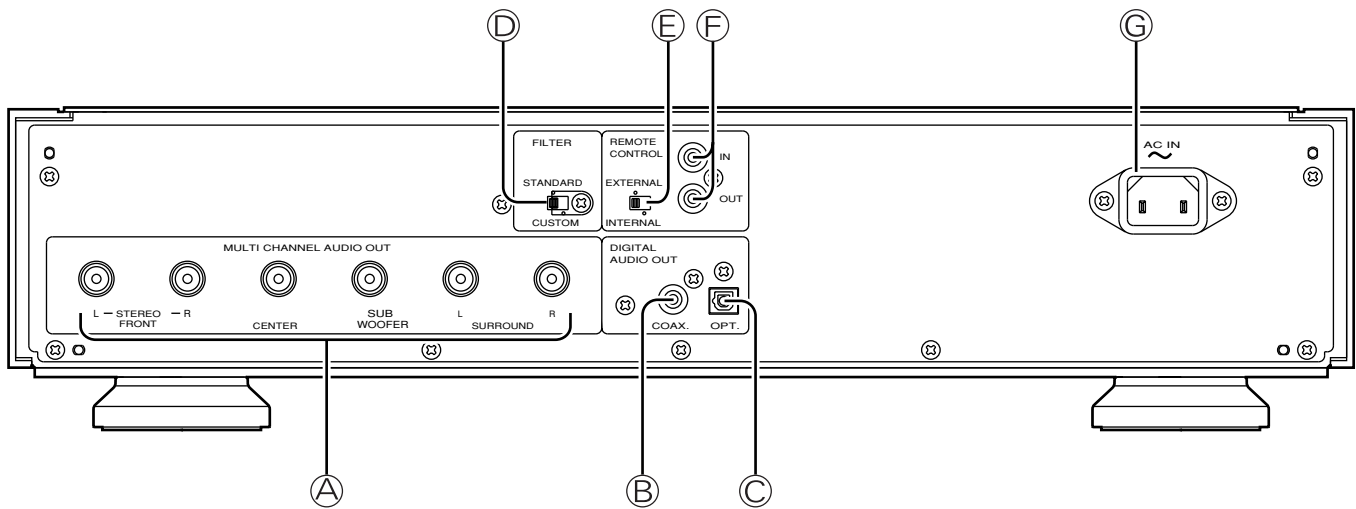

A MULTI CHANNEL AUDIO OUT (analog output) connectors

- STEREO FRONT L/R : Output connectors for front channel
- CENTER : Output connector for center channel
- SUB WOOFER : Output connector for sub-woofer channel
- SURROUND L/R : Output connectors for surround channel

B DIGITAL AUDIO OUT COAX. (coaxial digital output) connector

During play, the CD signal in digital format are output from this coaxial output connector.

Note:
No signals are output during Super Audio CD play.

C DIGITAL AUDIO OUT OPT. (optical digital output) connector

During play, the CD signal in digital format are output from this optical output connector.

Note:
No signals are output during Super Audio CD play.

D FILTER STANDARD/CUSTOM switch

The switch is used to select the setting that suits the amplifiers and speakers used. For further details, refer to "Filter Switch" on page 22.

Note:
Turn the power off before setting this switch. Setting the switch during play may cause noise to be generated.

E REMOTE CONTROL EXTERNAL/INTERNAL switch

Set this switch to INTERNAL (factory setting) when the player is to be used on its own.

Set it to EXTERNAL when connecting the remote control connectors on the player and on a Marantz AV component (equipped with an infrared sensor supporting RC-5*) using the accessory remote control connecting cables and using several components as a system.

* "RC-5" refers to the remote control signal system used as a standard feature on the component made by Marantz.

F REMOTE CONTROL IN, OUT (input and output) connectors

When the remote control connectors on the player and on a Marantz AV component are connected using the accessory remote control connecting cables, the components can be operated as a system by remote control.

- When connecting to a component which is equipped with remote control connectors, the player's REMOTE CONTROL IN connector must always be connected to the REMOTE CONTROL OUT connector on the other component to be connected.
- When connecting a component which is not equipped with an infrared remote sensor, this component must always be connected to the player's REMOTE CONTROL OUT connector.

G Power socket

Use the accessory power cable to connect the player to a household AC outlet.

CONNECTIONS

The method used to connect the player differs depending on the amplifier or AV amplifier used. In order to ensure that the components are connected properly, refer to the operating instructions of the components which will be connected.

Note:

When making the connections, push the plugs on the ends of the connecting cables firmly into place. Loose connections cause noise.

Connecting the player to a 2-channel stereo amplifier or AV amplifier

• **Performing the analog connections**

Use the accessory audio connecting cable ① to connect the player's MULTI CHANNEL AUDIO OUT (analog output) STEREO FRONT L and R connectors to the corresponding audio input connectors (such as the CD input connectors) on the stereo or AV amplifier to be used.

To listen to Super Audio CDs with these connections, set the SOUND MODE button to STEREO. (See page 17)

Note:

Do not connect the player's analog (audio) output connectors to the PHONO input connectors on the stereo or AV amplifier to be used.

• **Performing the digital connections**

This player comes with one OPTICAL digital output connector and one COAXIAL digital output connector.

Using an optical cable ② or coaxial cable ③ available from an audio store, connect the player to the digital input connectors on the AV amplifier, D/A converter, CD recorder or other component.

When a CD recorder or other digital recorder is connected, you can enjoy digitally recording the signals from CDs.

Notes:

- Digital signals are output only during CD play. No digital signals are output during Super Audio CD play.
- Do not bend or bundle the optical digital connecting cable.

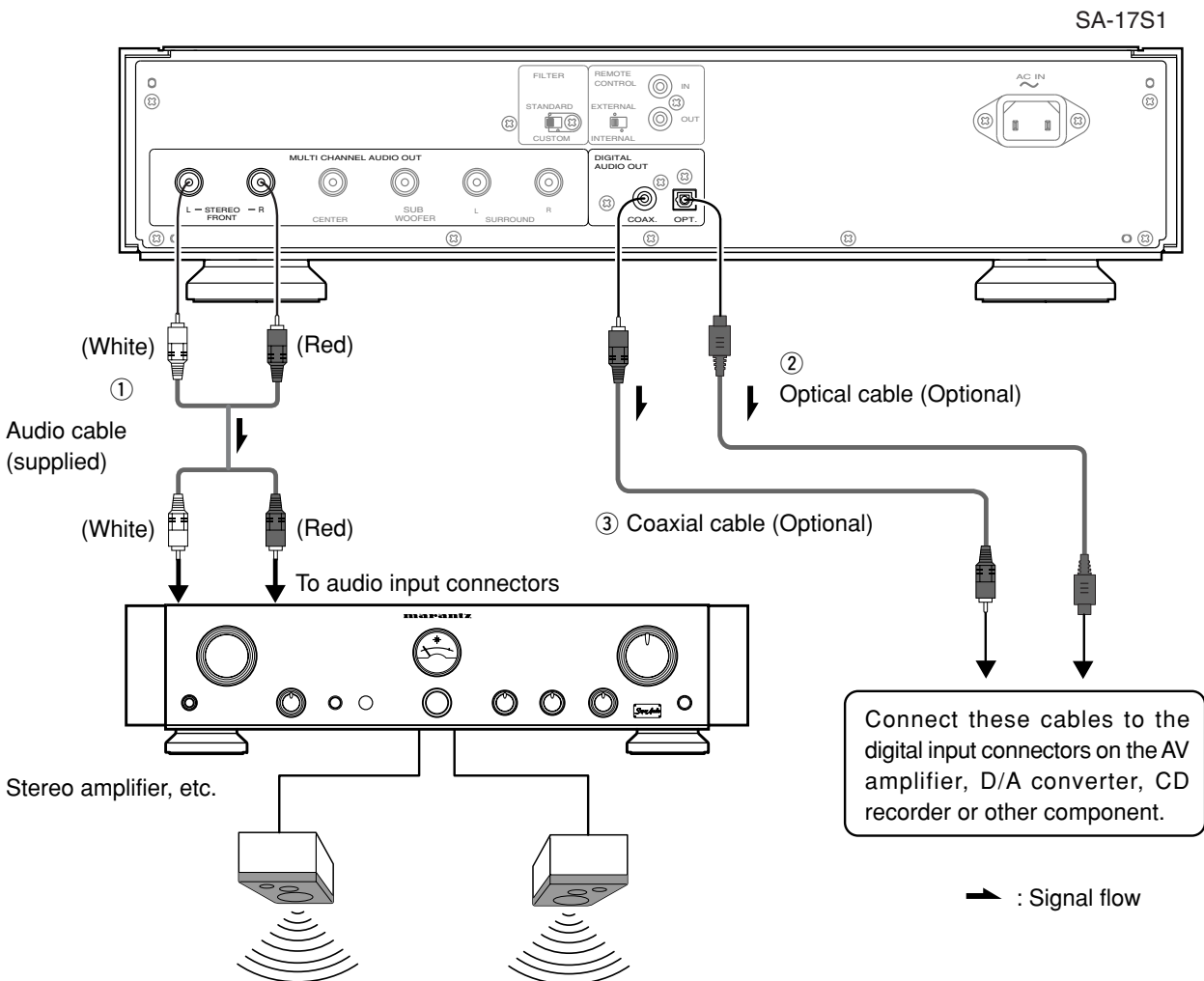

Connecting the player to an analog multi-channel amplifier or AV amplifier

This player can play Super Audio CDs which have been recorded in a multi-channel format. Set the SOUND MODE button to MULTI for multi-channel play. (See page 17)

- 1 Using the accessory audio cable ①, connect the player's MULTI CHANNEL AUDIO OUT (analog output) STEREO FRONT L and R connectors to the corresponding input connectors on the amplifier or AV amplifier to be used.
- 2 Using the accessory audio cable ②, connect the player's MULTI CHANNEL AUDIO OUT (analog output) CENTER and SUB WOOFER connectors to the corresponding input connectors on the amplifier or AV amplifier to be used.
- 3 Using the accessory audio cable ③, connect the player's MULTI CHANNEL AUDIO OUT (analog output) SURROUND L and R connectors to the corresponding input connectors on the amplifier or AV amplifier to be used.

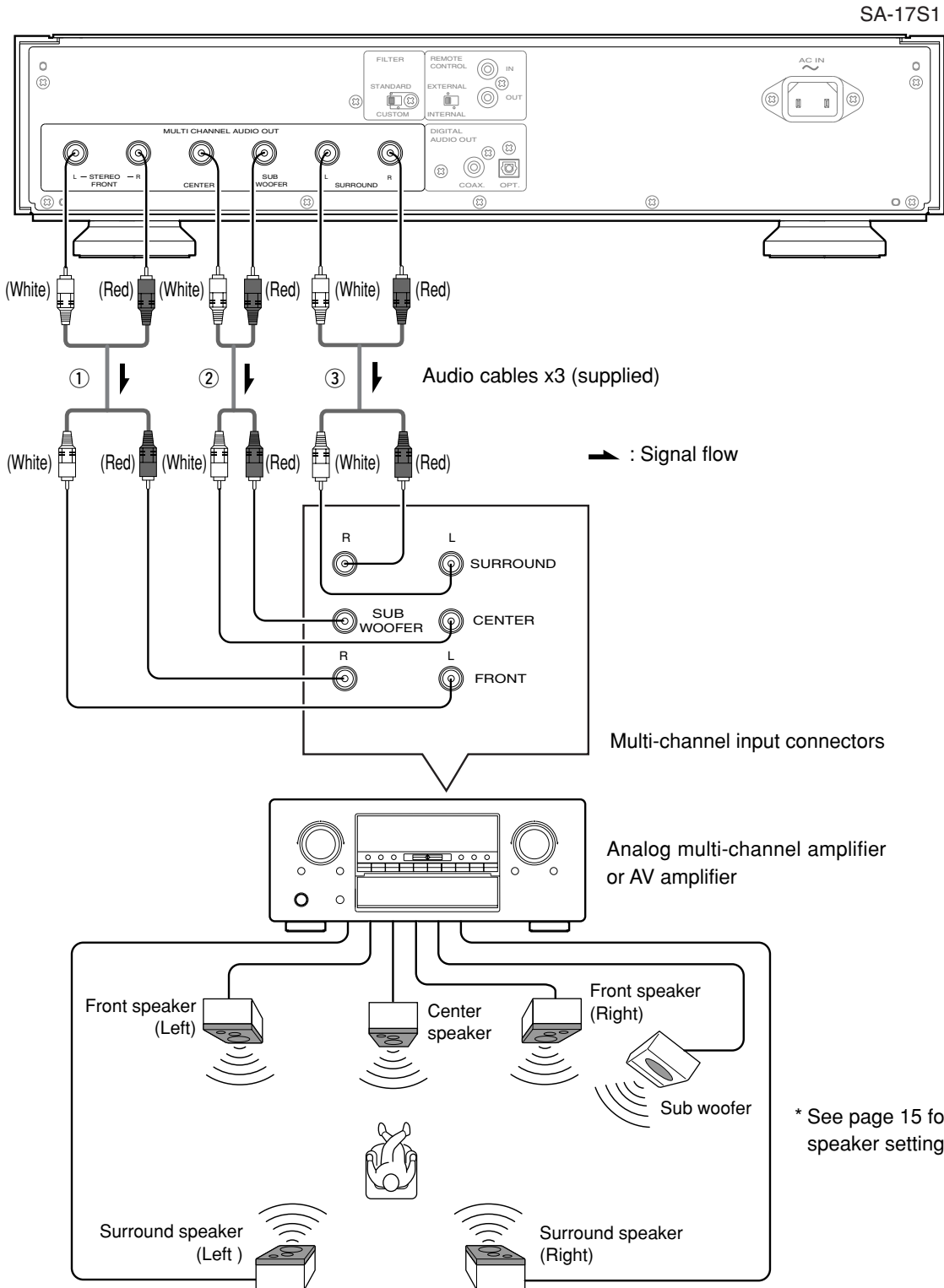

Connections when the phantom center function is to be used

Connect the cables (①, ② and ③) to the corresponding connectors on the analog multi-channel amplifier or AV amplifier. The phantom center function serves to synthesize in virtual terms the center channel with the front two (left and right) channels when SACD multi-channel discs recorded with 5 or 6 channels are to be played. To play discs recorded with 4 channels, set the phantom center function to OFF. (See page 17)

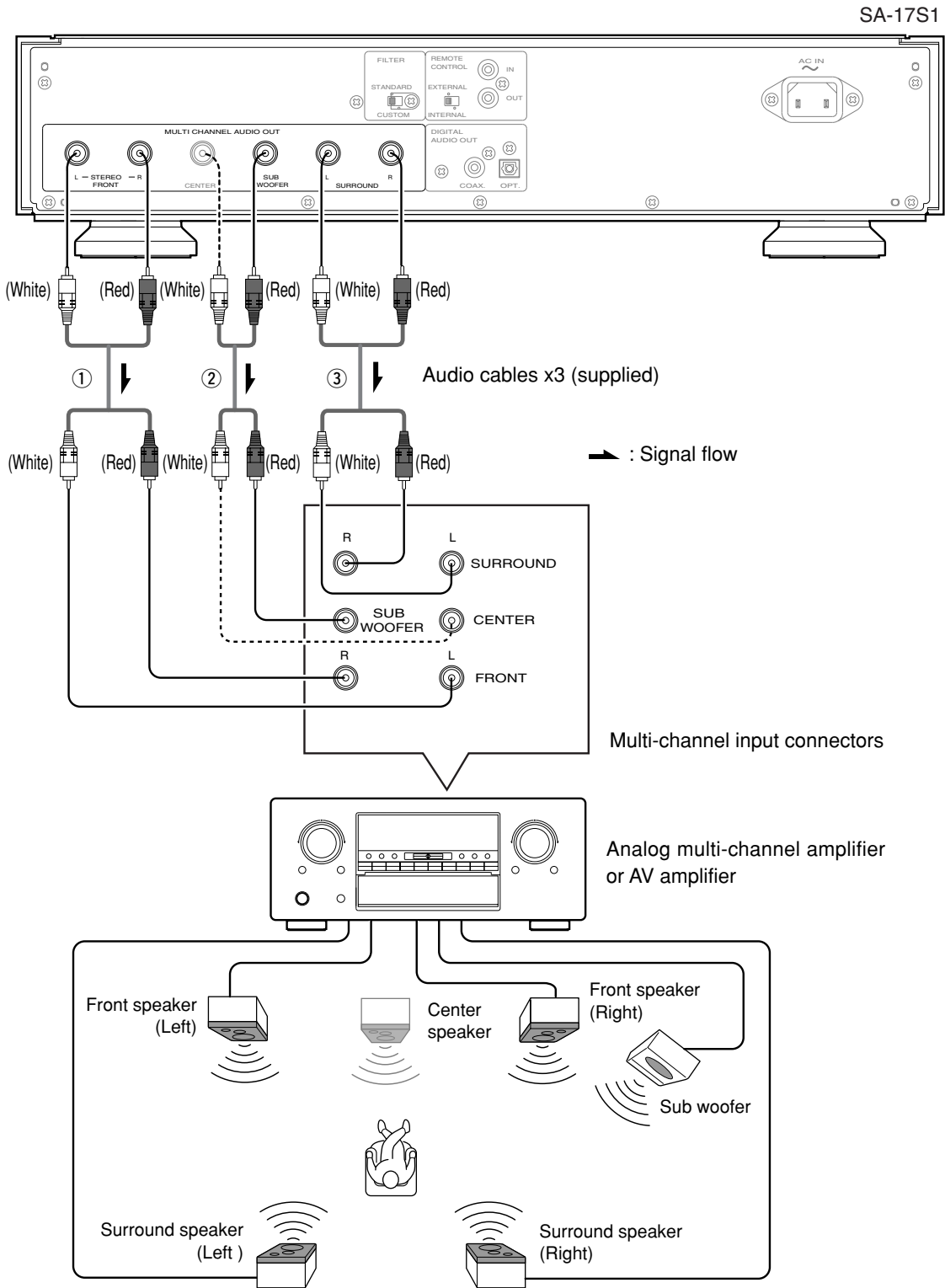

Installing the SACD multi-channel audio speakers

In order to enjoy SACD multi-channel sound with the best possible acoustics, it is recommended that the speaker systems be laid out in compliance with the ITU-R BS.775-1 recommendation which is a standard formulated by the International Telecommunication Union (ITU).

SACD multi-channel discs are recorded and mixed in such a way that they will achieve the optimum effects when the speaker systems are laid out as per the ITU-R BS.775-1 recommendation.

- On SACD multi-channel discs, the music signals are basically recorded using 5 channels (or 3, 4 or 6 channels in some cases). In some instances, however, LFE (for the sub woofer) is recorded as a sixth channel. Each disc indicates how many channels have been recorded on it.
- The basic settings are 3 speakers for front and 2 for back since multi-channel discs have basically 5 channels
The 2-front, 1-center, and 2-surround speakers should be set on the circle from the listening point as shown below.
When you use different sizes of speakers, please adjust the volume balances in your amplifier/surround receiver.

- The location of the sub-woofer in the picture is just to you a patter of settings. Sub-woofer can be located any place in your room. (See the users manual of your sub-woofer.)

■ (ITU) International Telecommunication Union

The ITU is a special organization of the United Nations. It consists of a number of organs, one of which is the Radio Broadcasting Section.

ITU-R BS in the recommendation which consists of standards relating to broadcasting (audio) operations, one of which is the ITU-R BS.775-1 which governs “multi-channel stereo sound systems.”

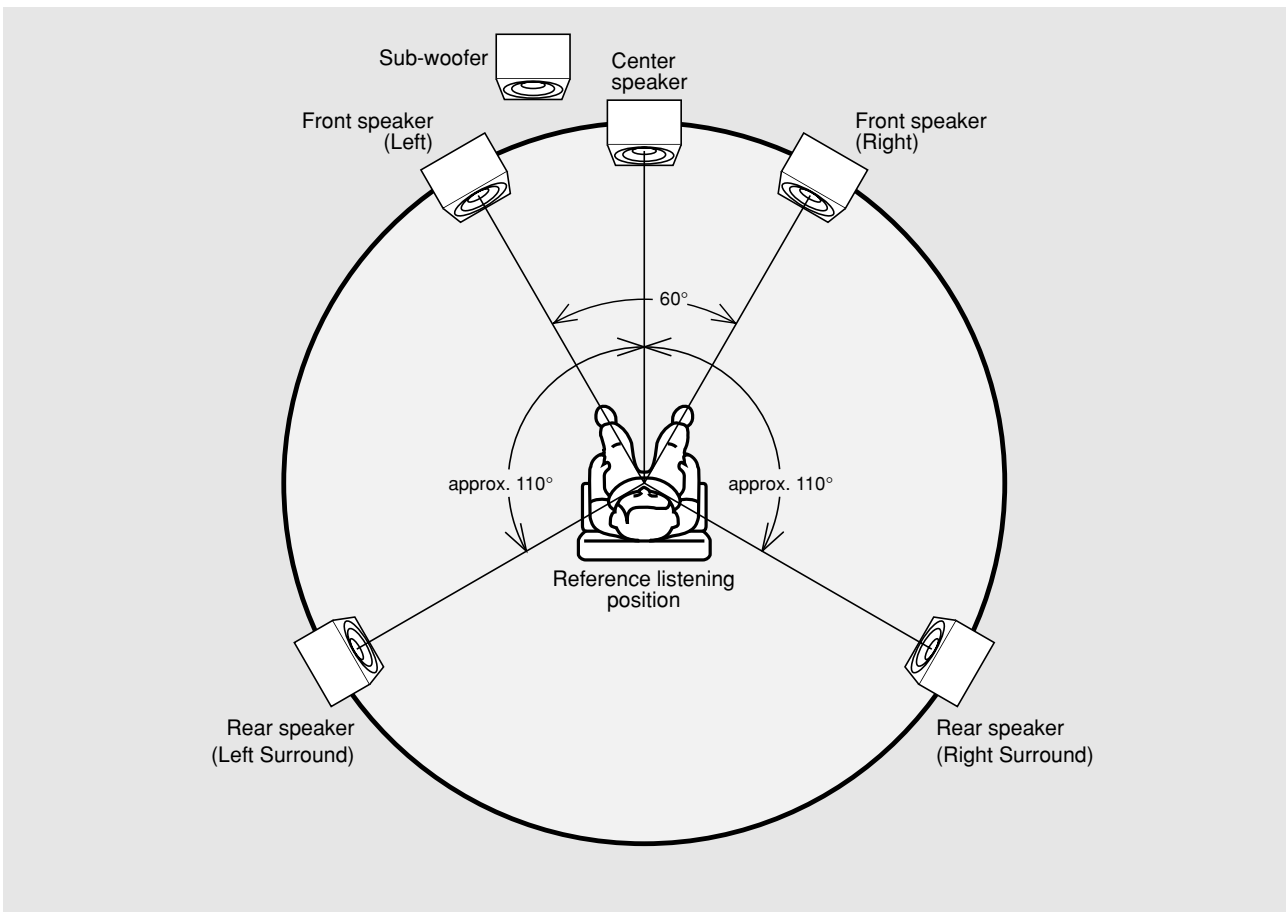

OPERATION

Preparing for disc play

- Referring to "Connections," connect the player and amplifier.
- Connect one end of the power cable supplied to the power socket on the player's rear panel.

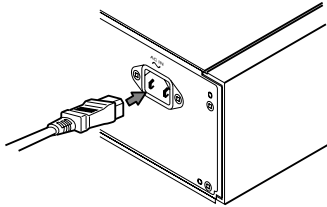

- Connect the other end to the power outlet.
- Set the power switch on the connected amplifier to ON.
- Use the amplifier's input selector to select the input connected to the player.

Disc play

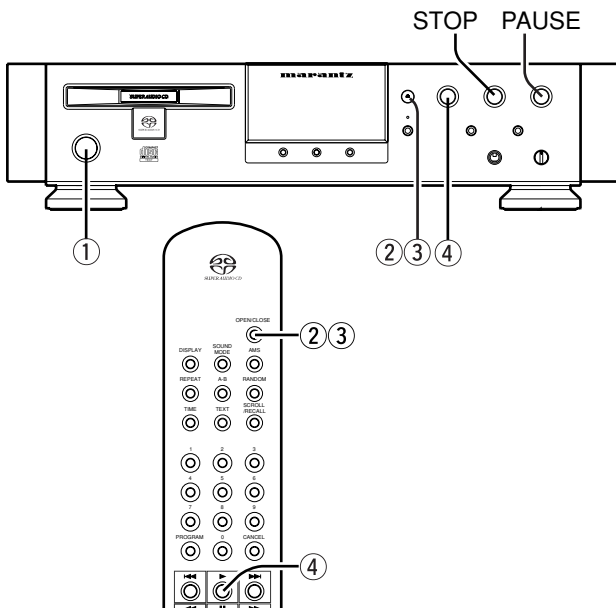

- Press the **POWER** switch to turn on the power of the player.

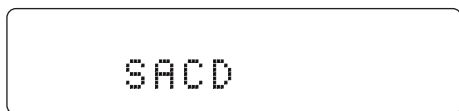

- Press the **▲ OPEN/CLOSE** button.
The disc tray comes out. Place the disc with its label side (side with the printed text) facing up on the tray. To play a single (8 cm) CD, align the disc with the indentation at the center of the tray when placing it on the tray.
- Press the **▲ OPEN/CLOSE** button to retract and close the disc tray.
- Press **▶ PLAY** button.
Disc type is automatically detected and playback is started. Track number and track elapsed time (minute, second) appear on the display. Playback automatically stops at the end of the final track.

(Exp.: Track 6, Elapsed time 2 min 8 sec)

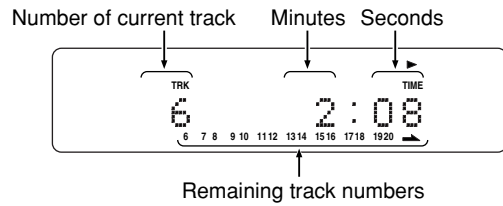

* When a SACD/CD hybrid disc (see page 5) is loaded, SACD layer is automatically played. If you want to play CD layer, use **SOUND MODE** button to select CD layer (see page 17).

How to use the buttons for operations relating to normal play

To stop playback

Press **■ STOP** button.

To pause playback

Press **⏸ PAUSE** button.

PAUSE indicator will light and playback is paused at the point that the button is pressed. To restart playback, press **⏸ PAUSE** button again or press **▶ PLAY** button.

To remove the disc

After stopping play, press the **▲ OPEN/CLOSE** button. The disc tray comes out, allowing the disc to be removed. After removing the disc, press the **▲ OPEN/CLOSE** button again to retract and close the disc tray. Be absolutely sure to keep the disc tray closed when the player is not going to be used.

To change time display

Press **TIME** button.

Each time **TIME** button is pressed, display will change in the following order. "Track elapsed time" → "Track remaining time" → "Total remaining time" → "Track elapsed time".

• Track remaining time

(The remaining playing time from the playing point to the end of the current track)

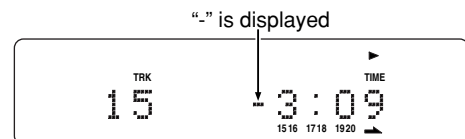

• Total remaining time

(The remaining playing time from the playing point to the end of the last track)

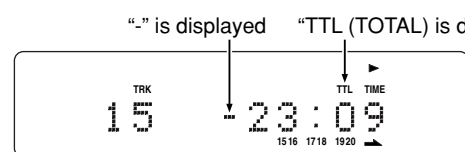

* If **TIME** button is pressed when a disc with text is played, time display is given priority and text information will not be displayed afterward. To see text information, press **TEXT** button.

Switching Sound Mode (SACD)

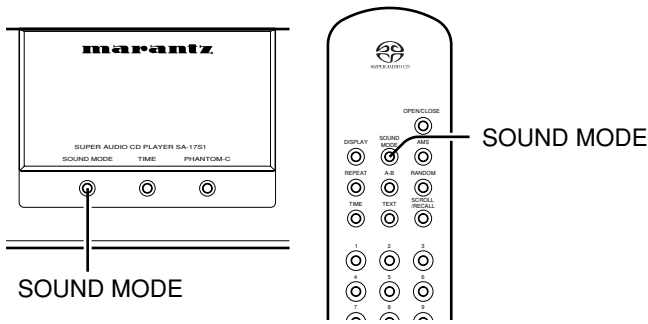

Press **SOUND MODE** button in stop mode (not playing). The layer or area currently in is shown on the display. (CD, SACD STEREO, SACD MULTI)
If **SOUND MODE** button is pressed again, a selectable layer or area will be shown. About 2 seconds after the layer or area will be switched to new one.

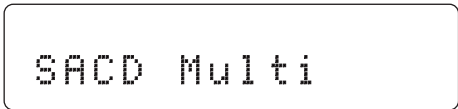

- * When layer or area is switched, TOC will be read again.
- * If a CD disc or SACD disc with stereo area only is loaded, sound mode cannot be changed.
- * When a hybrid SACD disc that has both stereo and multi-channel areas is loaded, sound mode will be changed in the following order.
SACD multi-channel area → SACD stereo area → CD layer
- * Sound mode can be selected while the tray is open. Select a desired layer or area and press ► **PLAY** button then the tray will close and playback will be started.

• **Displaying the number of tracks in a SACD multi-channel disc**

If **SOUND MODE** button is pressed once during playback, the number of channels being played will be shown.

Examples

6ch : Sub-woofer channel will be played.

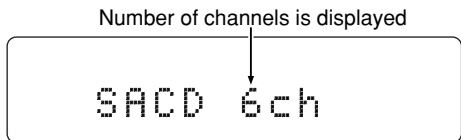

5ch : Sub-woofer channel will not be played.
For some discs recorded in 4ch or 3ch, "5ch" will be displayed.

4ch or 3ch : If loaded disc is made to show the channel display, 4ch or 3ch will be displayed.

* See software (disc) jacket or attached instruction for signal output terminals for 4ch or 3ch discs.

Start sound mode

When SACD discs with both multi-channel and stereo information areas are to be played, this player makes it possible to set the layer/area (multi-channel or stereo) to be played first.

- ① Press the **POWER** switch to turn on the power of the player.
- ② If a disc is already on the disc tray, remove it.
"No Disc" now appears on the display.
- ③ Hold down the player's **SOUND MODE** button for at least 2 seconds. The currently selected layer/area is displayed.
If the multi-channel layer/area is selected: Start Multi_
If the stereo layer/area is selected: Start Stereo
- ④ The sound mode is switched when the SOUND MODE button is pressed within 2 seconds.

Even when discs are changed over or the power turned off, the "start sound mode" setting is stored in the memory and remains unchanged.

Phantom center function

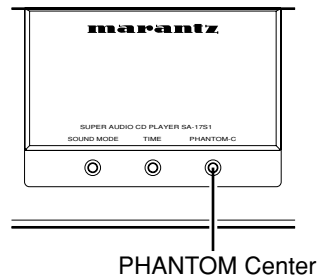

Concert halls have superb acoustics which are quite distinctive, and they are referred to as "hall tone." Provided that the speaker systems are laid out in their recommended positions, the SACD multi-channel format makes it possible to recreate an authentic sound field in which the listener can actually feel these superb acoustics.

Ideally, the sound should be reproduced through the same number of speakers as the number of channels recorded on the discs played, and when this is not possible, there will be some aspect of the reproduced sound field that will sound unnatural. In particular, if there is no center speaker, the sound field at the front will be extended to the left and right and feel unnatural.

In a situation like this, press the player's **PHANTOM-C** button to turn on the phantom center function in stop mode. This causes the center channel sound to be distributed to the front left and right channels, resulting in the synthesis of a virtual center channel. In this way, the function makes it possible to recreate a convincing sound field that has almost the same superb acoustics as the ones that would be reproduced with the center speaker.

The function is also effective when the center speaker differs from the stereo speakers.

To play discs recorded with 4 channels (two front and two surround channels), set the phantom center function to OFF.

Playing your favorite tracks of a disc

■ Specify track number to play (Direct Search)

Specify track number with numerical buttons (0-9) on the remote

(example)

3rd track : Press **3**.

12th track : Press **1** and then press **2** (within approximately 1.5 seconds).

If the first pressed number is only in the digit of ones and not in the digit of tens, search begins approximately 0.5 second after.

If a wrong number is pressed

Press correct number again.

* If a track number that is not in the disc is specified, "No Track" will be shown on the main display. Please specify a correct track.



No Track

■ Skipping to the previous or next track (Track Skip)

To listen to a track posterior to the current track

Press **▶▶/▶▶|** buttons on the main unit or **▶▶|** button on the remote the number of times you want to proceed tracks.

To listen to a track prior to the current track

Press **◀◀/◀◀|** buttons on the main unit or **◀◀|** button on the remote go back to the beginning of the current track. Then press **◀◀/◀◀|** buttons on the main unit or **◀◀|** button on the remote the number of times you want to go back.

* When the **◀◀/◀◀|** button on the player or **◀◀|** button on the remote control unit is pressed at the first track on the disc, operation moves to the last track; conversely, when the **▶▶/▶▶|** button on the player or **▶▶|** button on the remote control unit is pressed at the last track on the disc, operation moves to the first track.

■ Playing your favorite parts of a disc (Search)

If **◀◀/◀◀|**, **▶▶/▶▶|** buttons on the main unit or **◀◀|**, **▶▶|** buttons on the remote are kept pressing during playback, track search begins. Release the button when the point you want to listen to gets close.

* No sound can be heard during search.

Repeated disc play (Repeat Play)

■ All track repeat

When **REPEAT** button on the remote is pressed, "RPT" indicator will light up and all track repeat play begins.

To Return to Normal Play

Press **REPEAT** button two times. "RPT" indicator will disappear, repeat mode will be off and it returns to normal play mode.

* If **REPEAT** button is pressed when in program mode, programmed tracks are played repeatedly.

■ One Track Repeat

Press **REPEAT** button on the remote two times when the track is being played. "RPT", "1" indicators will light and the track will be played repeatedly.

To Exit from One Track Repeat

Press **REPEAT** button.

■ A-B Repeat

① Press **A-B** button on the remote at your chosen starting point. "A-" indicator will light up.

② Press **A-B** button again at your chosen end point. "B" indicator will light up and the chosen section will be played repeatedly.

To Exit from A-B Repeat

Press **A-B** button on the remote. "A-B" indicator will disappear, A-B repeat mode will be off and it returns to normal play mode.

* A-B repeat cannot be done when random play is going on.

Playing tracks in a random sequence (Random Play)

When **RANDOM** button on the remote is pressed, the unit shuffles track order and plays all the tracks in the shuffled order. It can be done in both playback and stop modes. The RNDM (random) indicator lights.

- The gap between tracks will be approximately 4 seconds during random play.

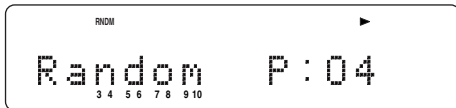

If **RANDOM** button is pressed when the disc tray is open and a disc is set, the tray will automatically close and random play will begin.

To Exit from Random Play and Return to Normal Play

Press **RANDOM** button again. The RNDM (random) indicator goes off, and random play is released.

If **▶▶/▶▶▶▶** buttons on the main unit or **▶▶▶▶** button on the remote are Pressed during Random Play

It jumps to the next track of the shuffled order.

If **◀◀/◀◀◀◀**, **▶▶/▶▶▶▶** buttons on the main unit or **◀◀, ▶▶** buttons on the remote are Pressed during Random Play

Search will be done only in the current track. Search does not go to the previous or next track.

To Listen to Random Play Repeatedly

Press **REPEAT** button on the remote once during random play. Every time the order will be shuffled.

- If **RANDOM** button is pressed during program play, the programmed tracks will be shuffled.

Playing tracks in a specific sequence (Program Play)

You can arrange and play tracks in a specific sequence. Up to 30 tracks to be played can be programmed.

(Example: To program the 7th track in a disc with 15 tracks)

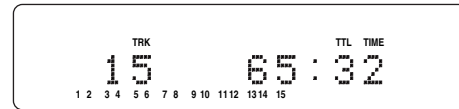

- ① Press **PROGRAM** button on the remote in stop mode. "PROG" indicator will blink and it goes to program mode.

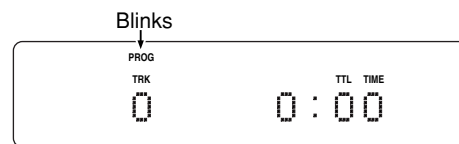
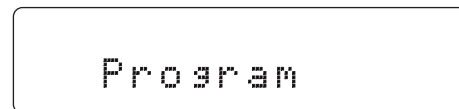

- ② Choose a track to be programmed with **numeric** buttons on the remote or **◀◀, ▶▶** buttons.

(Example: The 15th track is chosen and it's length is 4min30sec)

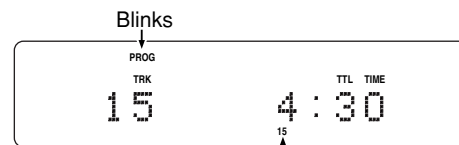

Only the numbers of programmed tracks light up

- ③ With the sequence described in step ② above, program another track. Repeat that sequence to program all the tracks you want. You can program up to 30 tracks.

(Example: The 7th track is chosen and total length of 7th and 15th is 7min50sec)

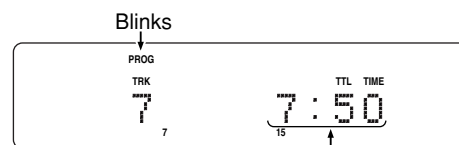

Total playing time of programmed tracks

- ④ When you finish programming, press **PROGRAM** button or **■ STOP** button. Blinking "PROG" indicator will lights up constantly. Program has been settled.

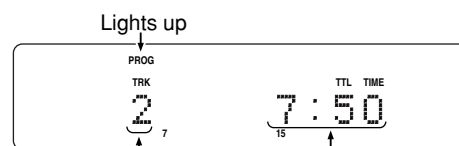

Total programmed number

Total playing time of programmed tracks

- ⑤ Press **▶ PLAY** button to starts playback in programmed order.

* You can skip the sequence ④ and press **▶ PLAY** button to start program play.

To Check Programmed Tracks

Press **SCROLL/RECALL** button on the remote while programming or program play (when “PROG” indicator is blinking or lighting up). Programmed tracks will be displayed in programmed order.

To Delete a Programmed Track

- ① Press **SCROLL/RECALL** button in stop mode when program has been made (when “PROG” indicator lights up or blinks). Programmed tracks will be displayed in programmed order.
- ② When the track you want to delete appears on the display, press **CANCEL** button on the remote at once. The deleted track’s track number indicator will disappear.

To Clear Whole Program

Press **STOP** button two times while in program play. In stop mode, press **STOP** or **CANCEL** button once. Program can also be cleared by pressing **OPEN/CLOSE** key to open the disc tray.

To Add Tracks to Program

Press **PROGRAM** button when program is remaining (“PROG” indicator is constantly lights up) and in stop mode. “PROG” indicator will blink and tracks can be added to the end of program.

*** Please be careful about the following matters.**

- When programming 1st to 9th tracks in a disc that has over 10 tracks by using numeric buttons,. For instance, programming the 3rd track after programming the 1st track, press 3 button more than approximately 1.5 seconds after 1 button is pressed.
- Likewise, when programming a track at 10th or after. For example, to program 13th track, press 3 button within approximately 1.5 seconds after 1 button is pressed.
- When programming a track in a disc that has less than 9 tracks. For instance, to program the 5th track after 4th track has been programmed, press 5 button more than approximately 0.5 second after 4 button is pressed.
- When programming with **◀◀** and **▶▶** buttons, press the buttons repeatedly until the track you want appears. And the gap has to be less than 0.5 second.

Q&A

- **How many tracks can be programmed?**
Up to 30 tracks can be programmed for program play.
- **Can I listen to program play repeatedly?**
Press **REPEAT** button once. “RPT” indicator will light and program play will be repeated.
- **Can I shuffle the programmed track order?**
Press **RANDOM** button during program play or in stop mode.

Searching your favorite tracks (AMS (Automatic Music Scan) Play)

If **AMS** button on the remote is pressed in stop mode or in playback mode, PLAY “▶” indicator will blink and the beginnings of all the tracks will be played for 10 seconds each starting from the first track. This feature is convenient to search where your favorite track is.

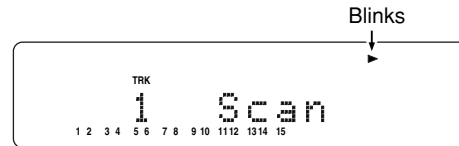

When you have found the favorite track, press **AMS** button again. PLAY indicator will light up constantly and normal playback will begin from the current track.

* If **AMS** button is pressed after tracks have been programmed, only the selected tracks will be played with AMS.

About TEXT Information Display

The following items of text information in a disc with text can be displayed by pressing **TEXT** button. Nevertheless, which items of information are recorded depends on discs so some information may not be displayed. This unit skips unrecorded information to display.

• During Playback

Each time **TEXT** button on the remote is pressed, text information will be displayed in the following order. In general, information of the playing track will be displayed during playback.

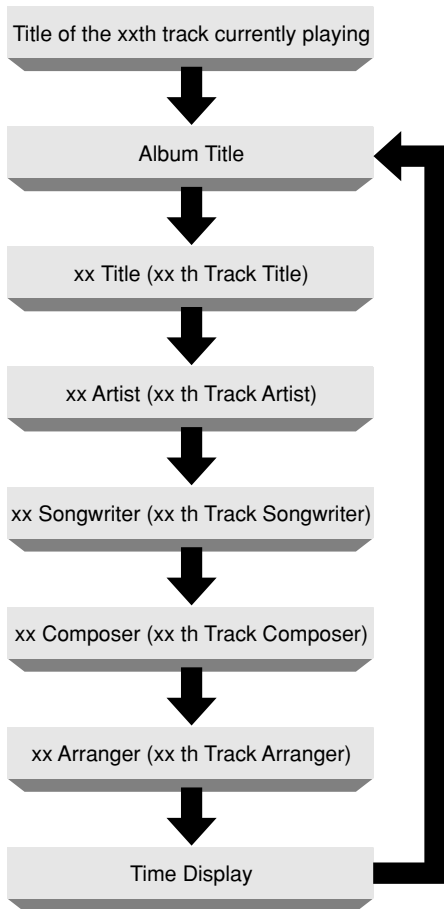

• In Stop Mode

Each time **TEXT** button on the remote is pressed, text information will be displayed in the following order.

If ► **PLAY** button is pressed while -- Title is displayed, that track will be played.

The maximum number of characters to be displayed is 64 characters.

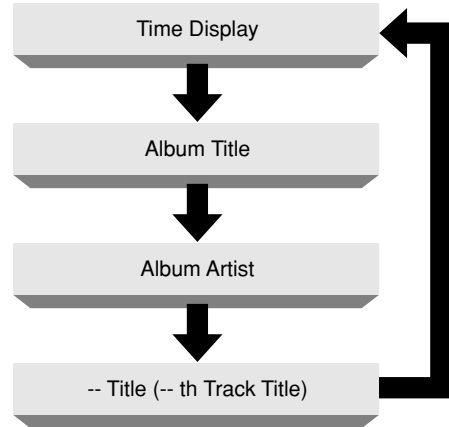

About TEXT

CD TEXT is a new type of music disc that contains text information like artist name, album title, music title, etc. CDs with the logos shown below and most SACDs have text information.



This text information is recorded on a area which is not used for ordinary music CDs. Therefore music CDs with text information can be played with ordinary CD player. And the text information can be displayed with players that has TEXT feature.

This unit automatically detects whether text information is recorded and shows it on the display window.

Main unit display

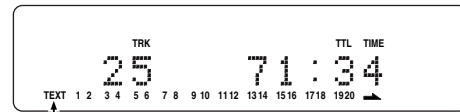

Lights up when the loaded disc has text information

Album title, track title, artist name, songwriter name, composer name, arranger name, can be displayed by operating main unit and remote control. Be noticed that those information items are not always recorded all in a disc.

- This unit can display 12 characters in one time. If information is longer than 12 characters, the display will scroll right to left.
- This unit can display only alphabets, numeric numbers and symbols. Chinese and Japanese characters cannot be displayed. If information is in Chinese and Japanese characters, the unit displays nothing.

Timer Play

This unit can perform timer play by cooperating with your audio timer.

Connect this unit's power cord to the audio timer's power socket and the timer's power cord to power outlet.

* For connection to audio timer and its operation, please refer to the instruction manual of your audio timer.

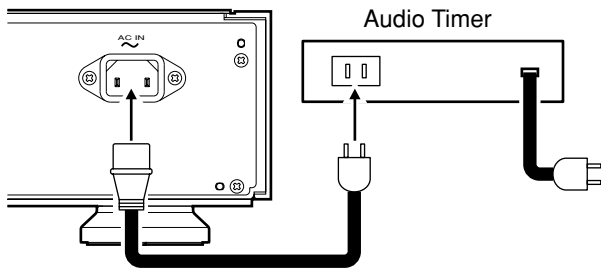

Setting method of Timer Play

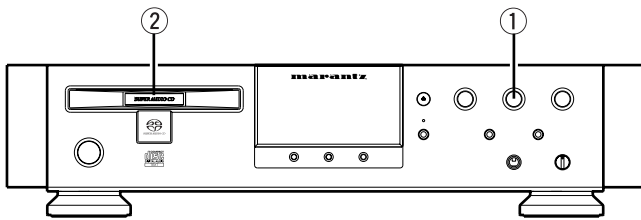

- ① Press ■ **STOP** button for 2 seconds in stop mode.
Timer play is activated and "Timer On" will be displayed.

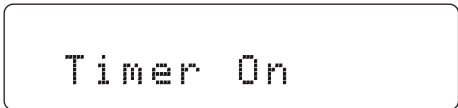

- * To turn off Timer Play, press ■ **STOP** button for 2 seconds.
("Timer Off" will be displayed.)
- ② Insert the disc to be played.
* If program play has been set, program play will begin upon the timer on.
- ③ Set the audio timer.

Filter Switch

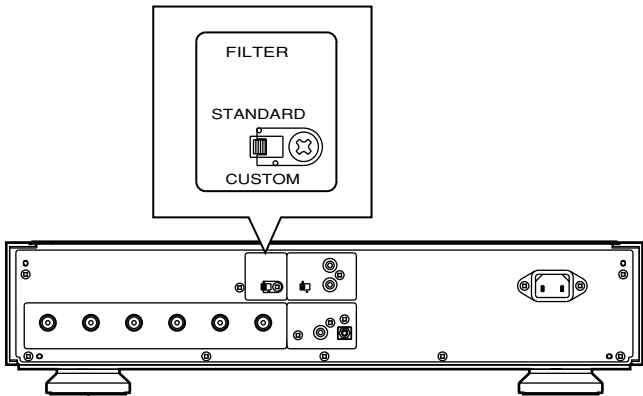

Super Audio CDs have a wide playback frequency band of 100 kHz that is beyond the audible range: this means that their signals contain ultra-high-range components that conventional CDs do not have. A conventional amplifier is often not built to reproduce signals containing these components, and when Super Audio CD signals are output in their original state, noise may be generated, the amplifier's protection circuits may be activated and/or the speakers may be damaged.

To prevent this sort of trouble from occurring, the unit incorporates a filter (STANDARD) for attenuating the ultra-high-range components, and the filter can be set STANDARD or CUSTOM using a switch on the rear panel. (This switch is set to STANDARD when the unit is shipped from the manufacturing plant.)

When the unit is to be connected with a next-generation amplifier that supports Super Audio CDs and set the switch to CUSTOM for use. This will ensure play with a wider frequency range.

- * Use the switch at the STANDARD position if the unit is to be used with a regular amplifier. Otherwise, the amplifier and/or speakers may be damaged.
- * Even when the unit has been connected with an amplifier that supports Super Audio CDs, change the switch to the STANDARD position when recording Super Audio CD sound on a tape deck, for instance.
- * Turn the power off before setting this switch. Setting the switch during play may cause noise to be generated.

TROUBLE SHOOTING

If you think a malfunction has occurred, first check the points listed below. The problem is likely to have been caused by a simple operational error or a connection problem. If the problem cannot be corrected even after carrying out the following checks, consult your dealer or nearest Marantz sales office or service counter.

- **The disc fails to rotate.**

1. Is the mains lead plugged in properly?
2. Is the POWER switch ON?
3. Is the disc placed in the correct position on the disc tray?
4. Is the disc placed properly with the label side facing up?
5. Is the disc dirty?
6. Is the disc scratched?
7. Is the disc warped?

- **The disc is rotating but no sound is heard.**

1. Are the amplifier and speakers connected properly?
2. Is the amplifier switch ON?
3. Is the amplifier's volume control set at the minimum level?
4. Is the amplifier's selector switch set to the correct input ("CD" or "AUX", whichever corresponds to the input jacks the SACD player is connected to)?

- **The disc stops in mid-operation.
The sound drops out or noise is heard.**

1. Is the disc dirty?
 2. Is the disc scratched?
 3. Is the disc warped?
- * In the case of a CD-R or CD-RW disc, this problem may occur when the conditions under which its data was originally written were substandard or when the quality of the disc itself is poor.

- **Remote control operation is not possible.**

1. Is the remote control unit's transmitter pointed correctly at the remote sensor on the front of the SACD player?
Or is there an obstruction between the transmitter and the remote sensor?
2. Are the batteries in the remote control unit exhausted?
3. Is there another strong light (from a window, etc.) striking the SACD player's remote sensor?

- **A Super Audio CD cannot be played.**

1. Is the disc scratched, dirty or warped?
2. Is the amplifier's input selector set to digital?
* Digital audio signal will not be output when a Super Audio CD is played.

- **Some channels are not played (Super Audio CD Multi-Channel)**

1. Confirm the number of channels in the disc. (See page 17)

- **A CD-R/CD-RW disc cannot be played.**

1. Is the disc placed upside down?
2. Is the disc contains properly written TOC?
3. Is the recorded information in an audio (CD-DA) format?

SPECIFICATIONS

	Super Audio CD	CD
Audio Characteristics		
Analog output		
Channels	6channels (Max.)	2channels
Frequency range	2Hz — 100kHz	2Hz — 20kHz
Frequency characteristics	2Hz — 50kHz (-3dB)	2Hz — 20kHz
Dynamic range	114dB	100dB
THD (1kHz)	0.0008%	0.0020%
wow & flutter	Precision of quartz	Precision of quartz
Output level	2.2V	2.2V
Digital output		
output level (cinch JACK)	—	0.5Vp-p (75Ω)
output level (optical)	—	-19dBm
Headphone output level	0.5W / 32Ω (max, Vol.)	0.5W / 32Ω (max, Vol.)
Optical Readout System		
Laser	AlGaAs	AlGaAs
Wave length	650nm	780nm
Signal format	1-bit DSD	16-bit linear PCM
Sampling frequency	2.8224MHz	44.1kHz

Power Supply

Input Voltage, Frequency AC 230V 50Hz
 Power Consumption 24W

Cabinet, etc.

Dimensions (Width × Height × Depth) 458 × 110 × 394mm
 Net weight 11.5kg
 Operating temperatures +5°C ~ +35°C
 Operating humidity 5 ~ 90% (without dew)

Accessories

- Remote control unit (RC-17SAS1) 1
 Dimensions (Width × Height × Depth) 44 × 17.5 × 239mm
 Net weight (without Batteries) 189g
- AAA (R03) Batteries 2
- AC Power cord 1
- Audio cable 3 pairs
- Remote connection Cable 1
- User's Guide 1

Specifications subject to change without prior notice.

www.marantz.com

You can find your nearest authorized distributor or dealer on our website.

JAPAN	Marantz Japan, Inc.	35-1 Sagami Ohno 7-Chome, Sagamihara-shi, Kanagawa 228-8505, Japan
U.S.A.	Marantz America, Inc.	1100 Maplewood Drive, Itasca, IL 60143, U.S.A.
EUROPE	Marantz Europe B.V.	P.O. Box 8744, 5605 LS Eindhoven, The Netherlands

marantz[®] is a registered trademark.

