

marantz®

Model PM4000 User Guide

INTEGRATED AMPLIFIER

FOREWORD

This section must be read before any connection is made to the mains supply.

WARNINGS

- Do not expose the equipment to rain or moisture.
- Do not remove the cover from the equipment.
- Do not push anything inside the equipment through the ventilation holes.
- Do not handle the mains lead with wet hands.

EQUIPMENT MAINS WORKING SETTING

Your Marantz product complies with the household power and safety requirements in your area.

“N” or “UK” Version product can be powered by 230 V AC only.

IMPORTANT:

This apparatus is fitted with an approved moulded 13 Amp plug. To change a fuse in this type of plug proceed as follows:

1. Remove fuse cover and fuse.
2. Fix new fuse which should be a BS1362 5A, A.S.T.A. or BSI approved type.
3. Refit the fuse cover.

If the fitted plug is not suitable for your socket outlets, it should be cut off and an appropriate plug fitted in its place.

If the mains plug contains a fuse, this should have a value of 5A. If a plug without a fuse is used, the fuse at the distribution board should not be greater than 5A.

NOTE: The severed plug must be destroyed to avoid a possible shock hazard should it be inserted into a 13A socket elsewhere.

HOW TO CONNECT A PLUG

The wires in the mains lead are coloured in accordance with the following code:

BLUE—“NEUTRAL” (“N”)

BROWN—“LIVE” (“L”)

1. The BLUE wire must be connected to the terminal which is marked with the letter “N” or coloured BLACK.
2. The BROWN wire must be connected to the terminal which is marked with the letter “L” or coloured RED.
3. Do not connect either wires to the earth terminal in the plug which is marked by the letter “E” or by the safety earth symbol \perp or coloured green or green-and-yellow.

Before replacing the plug cover, make certain that the cord grip is clamped over the sheath of the lead — not simply over the two wires.

COPYRIGHT

Recording and playback of any material may require consent. For further information refer to the following:

- Copyright Act 1956
- Dramatic and Musical Performers Act 1958
- Performers Protection Acts 1963 and 1972
- any subsequent statutory enactments and orders

ABOUT THIS USER GUIDE

Refer to the Figures on the pages at the rear of this user guide. The callout numbers on the Figures correspond to those found in the text. All references to the connections and controls that are printed in **BOLD** type are as they appear on the unit.

PRECAUTIONS

The following precautions should be taken when operating the equipment.

GENERAL PRECAUTIONS

When setting the equipment ensure that:

- the ventilation holes are not covered
- air is allowed to circulate freely around the equipment
- it is on a vibration free surface
- it will not be exposed to interference from an external source
- it will not be exposed to excessive heat, cold, moisture or dust
- it will not be exposed to direct sunlight
- it will not be exposed to electrostatic discharges

In addition, never place heavy objects on the equipment.

If a foreign body or water does enter the equipment, contact your nearest dealer or service center.

Do not pull out the plug by pulling on the mains lead, hold the plug. It is advisable when leaving the house, or during a thunder-storm, to disconnect the equipment from the mains supply.

CONNECTIONS (Figure 1)

CONNECTION OF TUNER

Connect the output jacks of your stereo tuner to the **TUNER** jacks of this unit.

CONNECTION OF COMPACT DISC PLAYER

Connect the output jacks of your CD player to the **CD** jacks of this unit.

CONNECTION OF TURNTABLE

Connect the L (Left) output cord of the turntable to the “**L**” **PHONO** jack of this unit, and connect the R (Right) output cord to the “**R**” **PHONO** jack. Also be sure to connect the turntable’s grounding wire to the **GND** jack of this unit. The **GND** jack does not have to be connected if the turntable is not provided with a grounding wire.

CONNECTION OF TAPE DECK

Connect the **IN** (recording input) jacks of the tape deck to the **TAPE OUT** jacks of this unit, and connect the **OUT** (playback output) jacks of the tape deck to the **TAPE IN** jacks of this unit.

CONNECTION OF SPEAKER SYSTEMS

This unit is equipped with two sets of **SPEAKER SYSTEM** terminals—**SYSTEM 1** terminals and **SYSTEM 2** terminals. Usually connect your speaker system to the **SYSTEM 1** terminals.

- The speakers in the speaker system should have an impedance between 8 and 16 ohms. If speakers with an impedance of less than 8 ohms are connected, the protection circuitry may be activated during play.
- Connect the Right channel speaker to the R terminals, and the Left channel speaker to the L terminals.
- The output terminals have positive (+: Red) and negative (–: Black) polarity, and each speaker also has the same polarity (+ and –). When connecting the speaker, be sure to connect the terminals with the same polarity (+ with +, – with –).

CONTROLS, CONNECTORS, AND INDICATORS

(Figure 2)

① PHONO INPUT JACKS

Connect the output jacks of a turntable to these jacks.

② GND (GROUND) TERMINAL

Connect the grounding wire from the turntable to this terminal.

③ CD PLAYER INPUT JACKS

Connect the output jacks of a Compact Disc player to these jacks.

④ TUNER INPUT JACKS

Connect the output jacks of the tuner to these jacks.

⑤ AUX INPUT JACKS

These are auxiliary input jacks which can be used to connect the audio outputs of AV components such as TV multiplex/stereo audio tuners, VCRs, and laserdisc players.

⑥ TAPE, CD-R/MD IN/OUT JACKS

Connect the play (output) jacks and record (input) jacks of tape decks to these jacks.

⑦ SPEAKER SYSTEMS 1/2 TERMINALS

Connect your speaker system(s) to these terminals.

⑧ REMOTE CONTROL BUS TERMINALS (REMOTE CONT. BUS)

Another item of audio equipment with a remote control bus terminal can be connected to these terminals by using a special-purpose cable. The bus **OUT** terminal is used to send signals to another item of equipment. The bus **IN** terminal is used to receive signals from another item of equipment.

⑨ POWER CORD

Connect to a household power outlet.

⑩ POWER SWITCH

Pressing once switches the power ON, and pressing again switches it OFF.

The **POWER** indicator lights when the **POWER** switch is ON, and goes out when the **POWER** switch is OFF.

⑪ REMOTE SENSOR

The remote sensor receives the infrared commands from the remote control unit. When an infrared signal is received from the remote control unit. The remote control unit must always be pointed directly at the remote sensor.

⑫ INPUT SELECTOR

Selects the program source to be recorded or played from the **PHONO**, **CD**, **TUNER**, **AUX**, **TAPE**, and **CD-R/MD**.

⑬ MUTING INDICATOR

Light up when the **MUTING** button in the remote control unit is pressed.

NOTE:

Be sure to check the **VOLUME** control setting before pressing this switch to cancel muting. If the muting is canceled while the volume setting is high, the speakers could be damaged.

⑭ VOLUME CONTROL

Adjusts the volume level. Turn the knob clockwise to increase the volume.

⑮ BALANCE CONTROL

Turn the knob to correct an unbalanced program source such as stereo broadcast or to vary the output level of the left or right channel. Note that, if the **BALANCE** control is turned fully in one direction, the sound will not be heard from the speaker on the other side.

⑯ LOUDNESS SWITCH

The **LOUDNESS** switch compensates for human hearing characteristics by boosting the bass and treble response at low volume levels to achieve a more pleasing tonal balance.

⑰ TONE DEFEAT SWITCH

- When the switch is not depressed, the audio signals are applied to the tone control circuit and the tone can be adjusted using the tone control knob.
- When the switch is depressed, the audio signals bypass the tone control circuit and the tone control knob does not function.

⑱ BASS AND TREBLE TONE CONTROLS

Adjusts the tone by controlling the levels of two frequency bands. Turn each control toward (+) to enhance the corresponding frequency band, or toward (–) to attenuate it.

TREBLE: Adjusts the high frequency level.

BASS: Adjusts the low frequency level.

⑲ REC SELECTOR SWITCH

Selects the tape dubbing mode between tape decks or the signal output at the **REC OUT** jacks.

⑳ SPEAKERS 1/2 SWITCHES

These switches are used to select the speaker system(s) connected to the **SPEAKER SYSTEM 1/2** terminals on the rear panel. If both the 1 and 2 switches are pressed to the low positions, two speaker systems can be used at the same time. When headphones are used for listening, set both switches 1 and 2 to OFF (high positions).

㉑ PHONES JACK

Insert the standard phone plug of the headphones into this jack.

OPERATION PROCEDURES

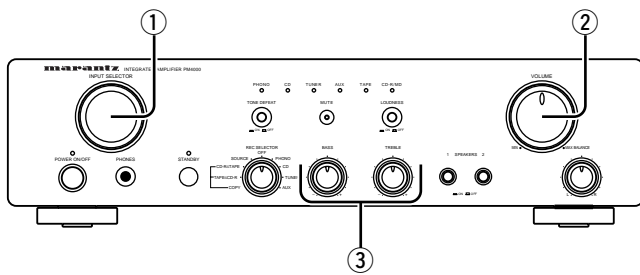

Operate each equipment to start play.

TO PLAY AN ANALOG DISK

1. Set the **INPUT SELECTOR** switch ① to **PHONO**.
2. Play a disk on the turntable.
3. Adjust the volume with the **VOLUME** control ② and adjust the tone with the **BASS** and **TREBLE** controls ③.

NOTES:

- Set the **VOLUME** control to the minimum position before placing the stylus on the disk or before replacing the cartridge.
- Do not apply shock or vibration to the turntable during play, as this may cause the stylus to jump and the analog disk to be damaged.
- If the turntable is installed too close to the speakers, the volume may not be able to be increased to a high level due to howling.
- Do not switch the power OFF while the stylus is on the disk surface.

TO LISTEN TO FM/AM BROADCASTS

1. Set the **INPUT SELECTOR** switch ① to **TUNER**.
2. Tune in the desired station on the tuner.
3. Adjust the volume with the **VOLUME** control ② and adjust the tone with the **BASS** and **TREBLE** controls ③.

TO PLAY A COMPACT DISC

1. Set the **INPUT SELECTOR** switch ① to **CD**.
2. Play a CD on the CD player.
3. Adjust the volume with the **VOLUME** control ② and adjust the tone with the **BASS** and **TREBLE** controls ③.

TO PLAY A COMPONENT CONNECTED TO AUX JACKS

The component connected to the **AUX** jacks on the rear panel can be played as follows.

1. Set the **INPUT SELECTOR** switch ① to **AUX**.
2. Play the component connected to the selected input.
3. Adjust the volume with the **VOLUME** control ② and adjust the tone with the **BASS** and **TREBLE** controls ③.

TAPE DECK OPERATION

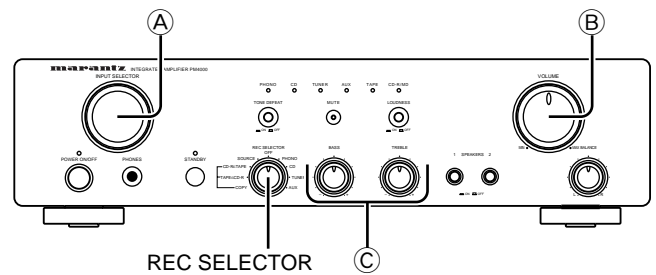

Control used for operating the tape deck.

TAPE PLAYBACK

1. Set the **INPUT SELECTOR** switch ① to **TAPE** or **CD-R/MD**.
2. Play a prerecorded tape on the tape deck.
3. Adjust the volume with the **VOLUME** control ②.
4. Adjust the tone with the **BASS** and **TREBLE** controls ③.

TAPE RECORDING

The playback sound of a program source component, such as a turntable, a tuner, or a CD player, can be recorded on tape as follows.

1. Set the **INPUT SELECTOR** switch ① to the program source to be recorded.
2. Play the program source.
3. Operate the tape deck(s) to record the playback sound on tape(s).

Using REC SELECTOR switch

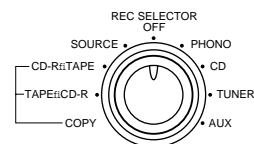

The **REC SELECTOR** switch is used when copying a cassette tape to another tape or recording a CD onto a cassette tape.

1. When the switch is in the **OFF** position, the signal is not output at the **REC OUT** jacks.
It is not necessary to output the signal at the **REC OUT** jacks when the signal is not recorded onto tape.
By setting the switch to **OFF**, the signal path inside the unit can be shortened and crosstalk, etc., can be reduced.
2. In the **SOURCE** position, the signal selected with the **INPUT SELECTOR** switch can be recorded onto tape.
3. In the **TAPE COPY** positions, the **TAPE** signal can be recorded onto **CD-R/MD** or vice versa.
4. In the **TAPE COPY** position, the program source selected with the **INPUT SELECTOR** switch can be monitored through the speakers.

REMOTE CONTROL UNIT RC8000PM

The RC8000PM can be used to control a Marantz AV component equipped with a remote sensor as well as other Marantz components connected to the first component through the Remote Control Bus. The buttons of the RC8000PM are laid out on its control panel according to the functional groups as described below.

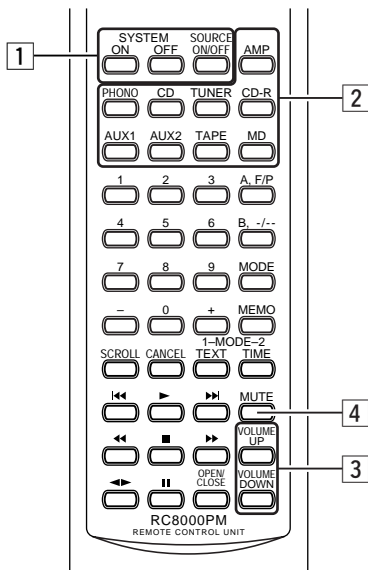

1 POWER ON/OFF

a. SYSTEM ON button

The equipment of Marantz can be turned on at the same time in this button.

(However, this operation is limited to the equipment of Marantz with the standby function.)

b. SYSTEM OFF button

The equipment of Marantz can be turned off at the same time in this button.

(However, this operation is limited to the equipment of Marantz with the standby function.)

c. SOURCE ON/OFF button

After the **AMP** button is pushed, this button is pushed, the set is turned on and off.

2 FUNCTION SELECT button

TUNER button : When this button is pushed the input of TUNER is selected.

PHONO button : When this button is pushed the input of PHONO is selected.

TAPE-1 button : When this button is pushed the input of TAPE is selected.

MD button : When this button is pushed the input of MD/CD-R is selected.

CD-R button : When this button is pushed the input of MD/CD-R is selected.

AUX button : When this button is pushed the input of AUX is selected.

3 VOLUME UP/DOWN button

UP button : VOLUME knob turns when this button is pushed and the volume level is grows.

DOWN button : VOLUME knob turns when this button is pushed and the volume level is falls.

4 AUDIO MUTE button

When this button is pushed, the sound is not temporarily emitted from the speakers.

When this button is pushed again, MUTE is released.

Moreover, when up/down of the volume is operated by remote control, MUTE is released.

Other buttons are not applied to PM4000.

Please see at the owners manual of other equipment's about the operation of button.

USING THE REMOTE CONTROL UNIT

1. Remote control

Operate the remote control unit within a distance of approx. 5 m from the infrared signal reception window (remote sensor) on the front of the Amplifier.

Remote control operation may not be possible if the remote control unit's transmitter is not pointing in the direction of the remote sensor or if there is an obstruction between the transmitter and the sensor.

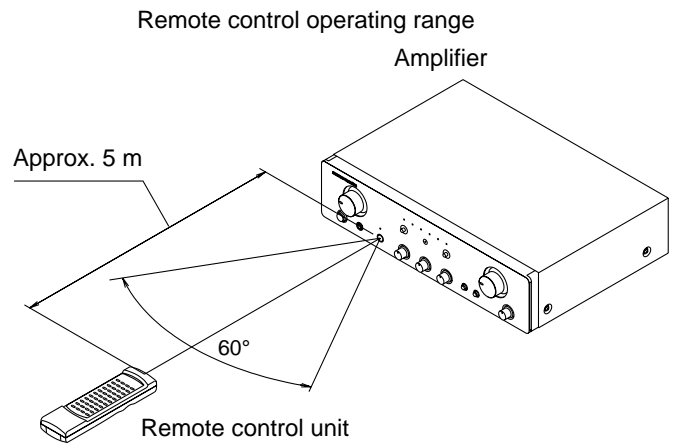

2. Loading batteries

Batteries in this remote control unit have a life of approximately 1 year under normal operating conditions. When the remote control unit is not to be used for an extended period of time, remove the batteries. Also, when you notice that the batteries are starting to run down, replace them as soon as possible.

(1) Remove the battery cover.

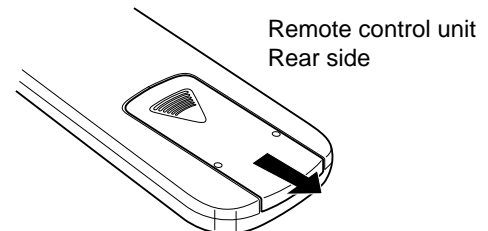

(2) Insert batteries with correct + / - orientation.

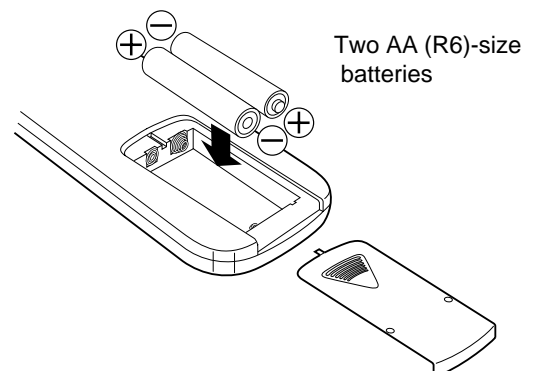

(3) Close the battery cover until it clicks shut.

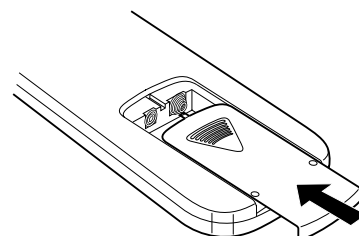

CARE AND MAINTENANCE

This section describes the care and maintenance tasks that must be performed to optimize the operation of your Marantz equipment.

CLEANING OF EQUIPMENT EXTERNAL SURFACES

The exterior finish of your PM4000 will last indefinitely with proper care and cleaning. Never use scouring pads, steel wool, scouring powders or harsh chemical agents (e.g., lye solution), alcohol, thinners, benzine, insecticide or other volatile substances as these will mar the finish of the equipment. Likewise, never use cloths containing chemical substances. If the equipment gets dirty, wipe the external surfaces with a soft, lint-free cloth.

If the equipment becomes heavily soiled:

- dilute some washing up liquid in water, in a ratio of one part detergent to six parts water
- dip a soft, lint free in the solution and wring the cloth out until it is damp.
- wipe the equipment with the damp cloth.
- dry the equipment by wiping it with a dry cloth.

REPAIRS

Only the most competent and qualified service technicians should be allowed to service the equipment. The Marantz company and its factory-trained warranty station personnel have the knowledge and special facilities needed for repair and calibration of this precision equipment. After the warranty period has expired, repairs will be performed for a charge if the equipment can be returned to normal operation.

In the event of difficulty, refer to your dealer or write directly to the nearest location to you that is listed on the Marantz Authorised Service Station list. If writing, please include the model and serial number of the equipment together with a full description of what you think is abnormal about the equipment's behaviour.

TROUBLE SHOOTING

In case of trouble or abnormal operation of the unit, check the following before contacting service personnel. What may seem to be a serious malfunction is often the result of a simple operation mistake. If the trouble persists after checking the following, please contact your dealer or nearest Marantz distributor.

The amplifier does not operate and the indicators do not light.

1. Check to see if the power cord is inserted properly into the power outlet.

The indicators light but the amplifier does not operate.

1. Check to see if the **SELECTOR**, **SPEAKER** switches and **VOLUME** control are properly set.

Sound is heard from only one of the speakers.

1. Check to see if the **BALANCE** control is properly set.
2. Switch the power of the unit to OFF, and change the connections of the left and right speaker cords. If the sound from the same speaker is still not heard, its connection cord or the speaker itself may be defective.

Considerable hum noise is heard when the turntable is played.

1. Check to see if the plugs from the turntable are properly connected to the **PHONO** jacks.
2. Connect the grounding wire of the turntable to the **GND** terminal on the rear panel of this unit. If it has already been connected, try removing it.
3. Check to make sure that the phono cartridge is attached securely to the tonearm.
4. Unplug the power cord and plug it in again after inverting the orientation of the blades.

Remote control operation is not possible.

1. Is the remote control unit's transmitter pointed correctly at the remote sensor on the front of the Amplifier?
Or, is there an obstruction between the transmitter and the remote sensor?
2. Are the batteries in the remote control unit exhausted?
3. Is there another strong light (from a window, etc.) striking the Amplifier remote sensor?
4. Is an RCA cord connected to the "REMOTE CONTROL IN" jack on the Amplifier rear panel?

MODEL PM4000 TECHNICAL SPECIFICATIONS (DIN)

Power output

RMS 8 Ohms/4 Ohms (40 Hz – 20 kHz)	30 / 40 W
DIN 8 Ohms / 4 Ohms	35 / 45 W

IHF dynamic power

8 Ohms / 4 Ohms	50 / 80 W
THD at 8 Ohms RMS rated output	0.005%
Intermodulation distortion	0.005%
Damping factor	80

Magnetic cartridge input

Input sensitivity impedance	2.5 mV / 47 k ohms
Accuracy of frequency response to RIAA	0.5 dB
Signal to noise ratio	80 dB

Tuner / CD / Aux / Tape inputs

Input sensitivity impedance	150 mV / 20 k ohms
Signal to noise ratio	105 dB
Frequency response (-1 dB)	10 – 50 kHz
Tone characteristic (100 Hz and 10 kHz)	-6 dB
Channel separation	70 dB

General

Power Requirements

N, UK version	230 V AC, 50 Hz
---------------------	-----------------

Dimensions (MAX)

Width	440 mm
Height	116 mm
Depth	293 mm
Weight	6.0 kg

Specifications subject to change without prior notice.

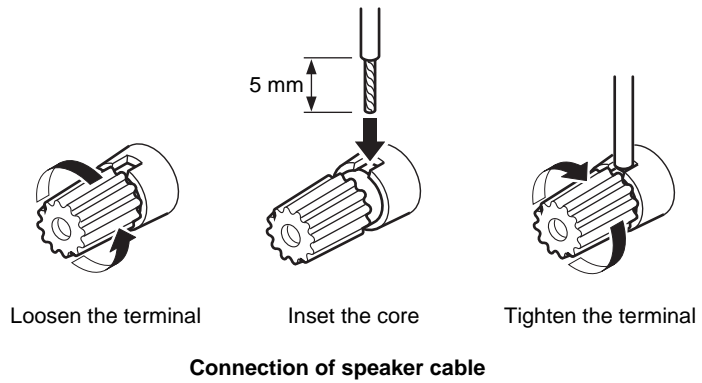
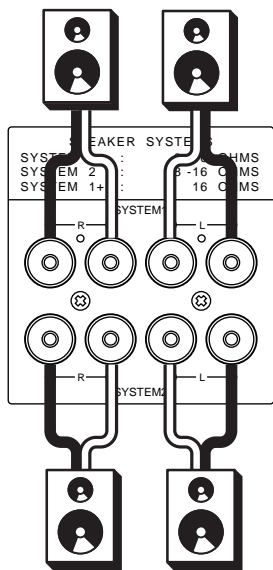
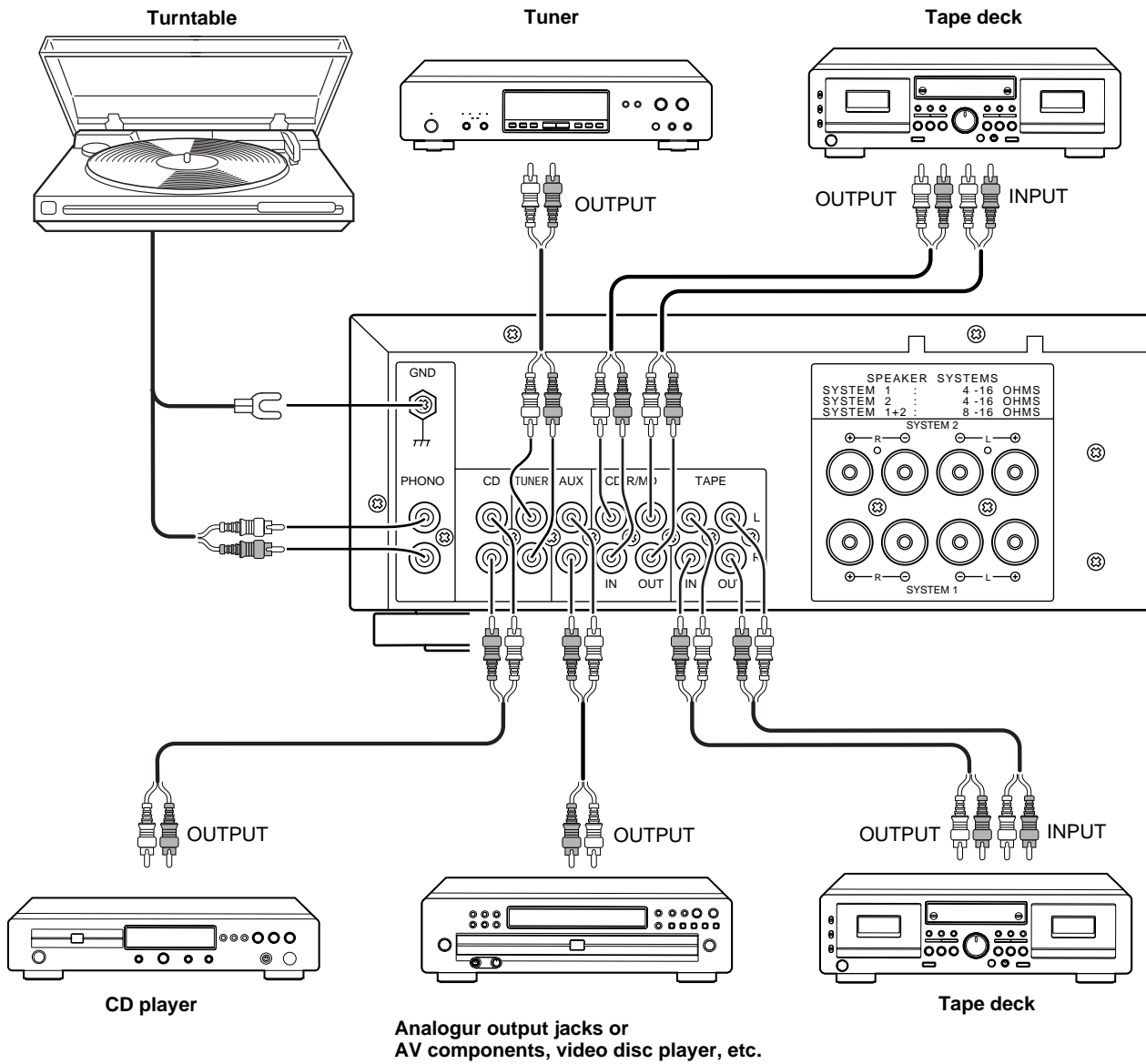

Figure 1

Model PM4000

N Version

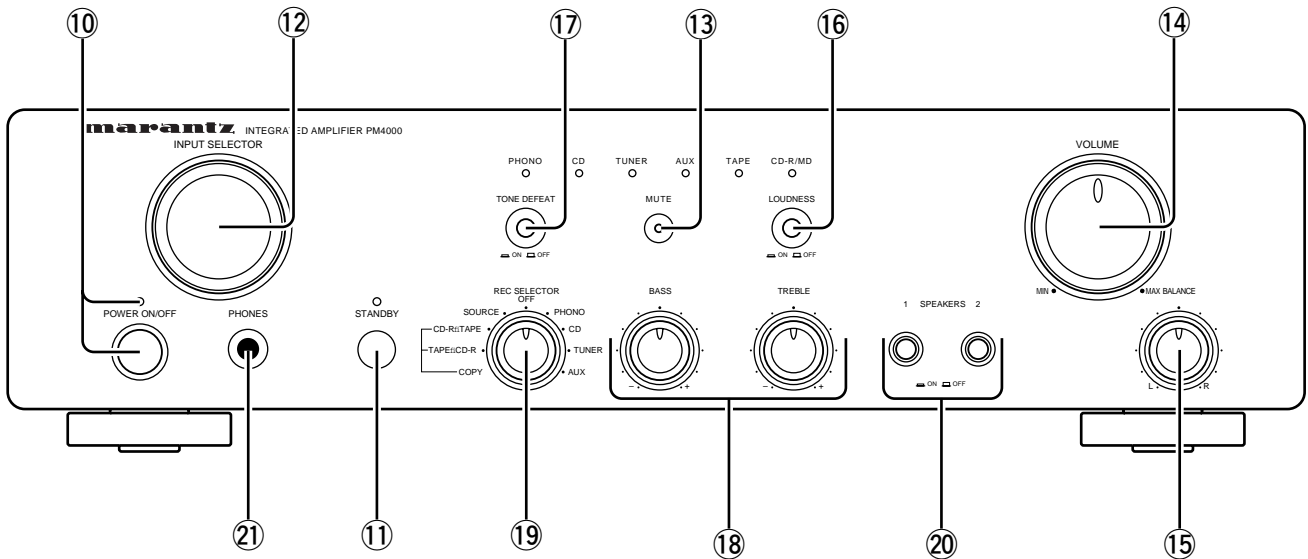
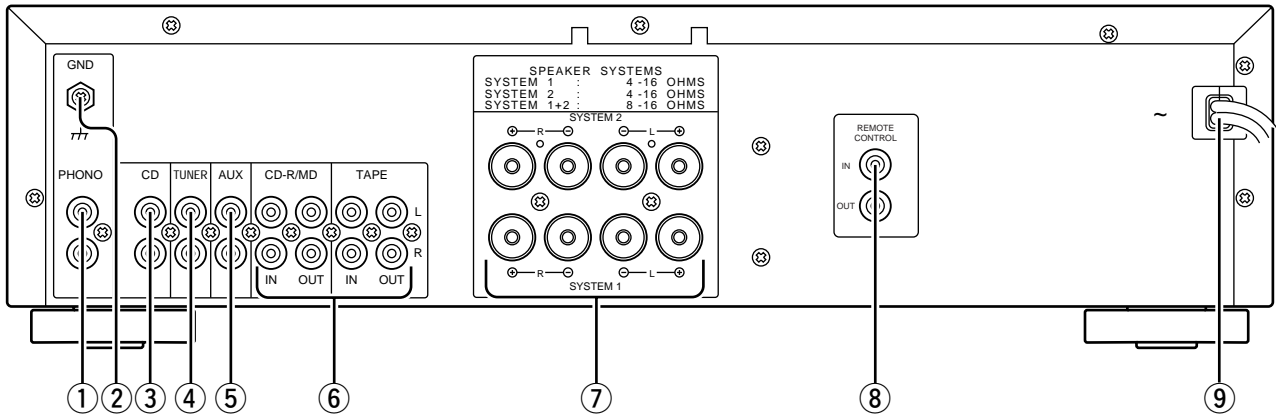

Figure 2