

ENGLISH

FRANÇAIS

ESPAÑOL

marantz®

AV Pre Tuner **AV7704**

Quick Start Guide

Guide de démarrage rapide /
Guía de inicio rápido

Read Me First....

Lisez-moi en premier.... /
Lea esto primero....

**Please do not
return this unit to
the store.
If you need help...**

Check our AVR setup tips online
Us.Marantz.com/SetupTips
Ca.Marantz.com/SetupTips

Call for Assistance
1-855-ONE-Marantz (USA)
1-855-663-6272
1-800-668-0652 (Canada)

Monday – Friday 10:00AM to 10:00PM E.S.T
Saturday 12:00PM to 8:00PM E.S.T





Welcome

Thank you for choosing a Marantz Pre Tuner.

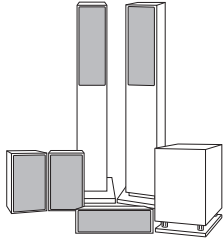

This guide provides step-by-step instructions for setting up your Pre Tuner.

Before You Begin

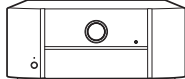
Required for Setup

 TV	 or  RCA cables XLR cables	 Speakers / Speaker cables
 HDMI cable	 Power amplifier	

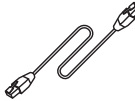













Optional

 LAN cable	or	 Wi-Fi router
--	----	---



- When connecting this unit to a device that is compatible with the Deep Color, 4K and ARC functions, use a “High Speed HDMI cable with Ethernet” that displays the HDMI logo.
- These drawings are for illustrative purposes only and may not represent the actual product(s).

What's In the Box

Quick Start Guide		FM indoor antenna	
Safety Instructions		AM loop antenna	
Notes on radio		Sound calibration microphone	
Warranty (for USA / for CANADA)		Sound calibration microphone stand	
Cable labels		Remote control unit (RC037SR)	
Pre Tuner		R03/AAA batteries	
Power cord		External antennas for Bluetooth/ wireless connectivity	



- The included sound calibration microphone stand is convenient for use when performing Speaker Calibration. Using your own tripod or the supplied Sound calibration microphone stand enables settings to be automatically configured to the optimum listening environment, providing exceptionally high performance.

Important: External Antennas

The removable external antennas are required for both Bluetooth and Wireless network connectivity. Please make sure to connect the antennas before attempting to use the Bluetooth or Wi-Fi features of the AV7704.

❑ Connecting the external antennas for Bluetooth/Wireless connectivity

For each of the two antennas:

- ① Place the antenna evenly over the antenna terminal located at the upper left or right corner of the rear panel.
- ② Turn the antenna clockwise until it is fully connected. Do not over tighten.
- ③ Rotate the antenna upwards for the best possible reception.

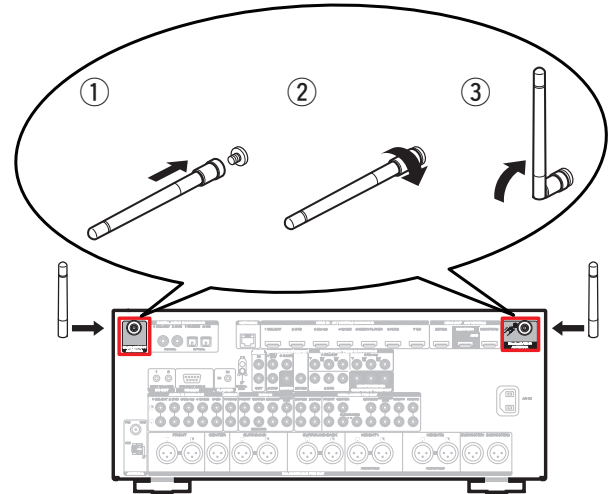

Setup

There are four steps to the setup process.

- 1** Installing batteries in the remote control unit
- 2** Connecting the Pre Tuner, Power Amplifier and your TV
- 3** Following the On-Screen Setup Assistant
- 4** Downloading the Mobile Apps

1

Installing batteries in the remote control unit

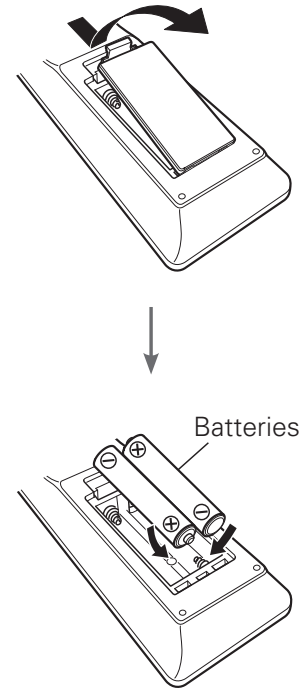

2 Connecting the Pre Tuner, Power Amplifier and your TV

1) Place the Pre Tuner and Power Amplifier near your TV and connect the power cord

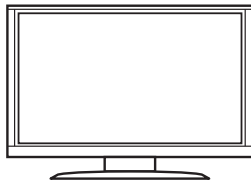

TV

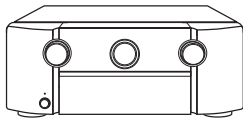

Pre Tuner



Power Amplifier

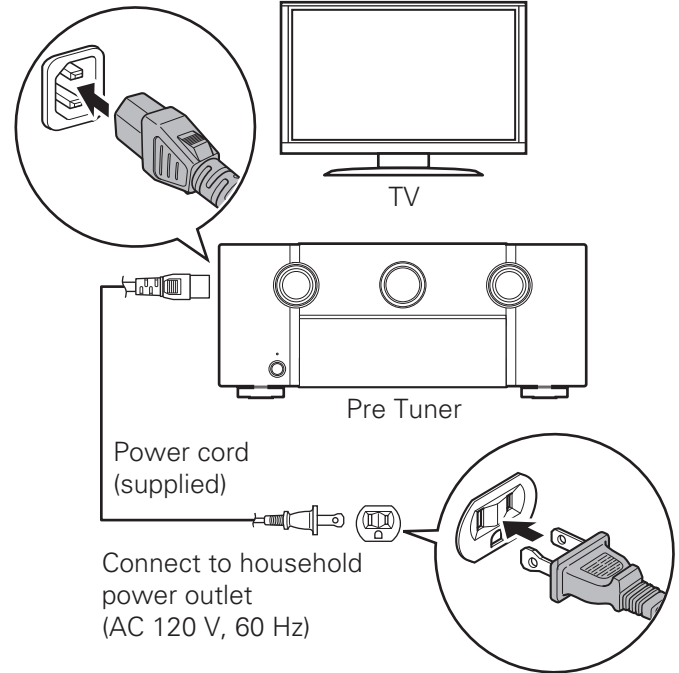

2) Connect the Pre Tuner to your home network

Wired LAN

Connect an Ethernet cable (not included) between your Pre Tuner and your network router.

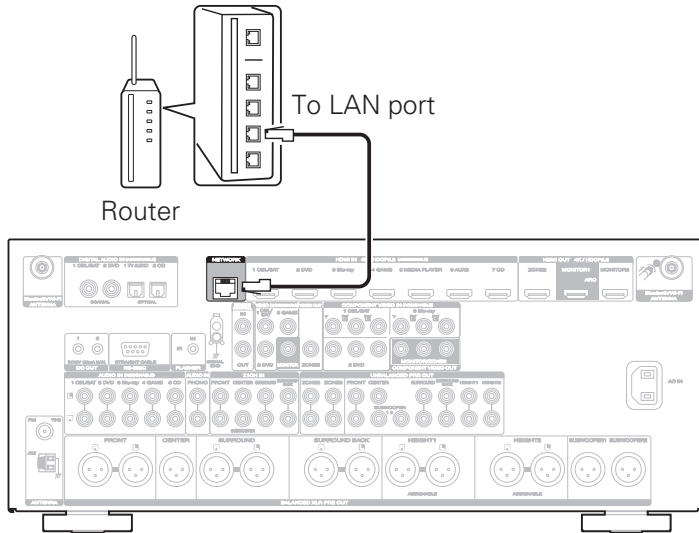

Wireless LAN

When connecting to wireless LAN (Wi-Fi), follow the instructions in "Connecting the external antennas for Bluetooth/Wireless connectivity" and connect the antennas.

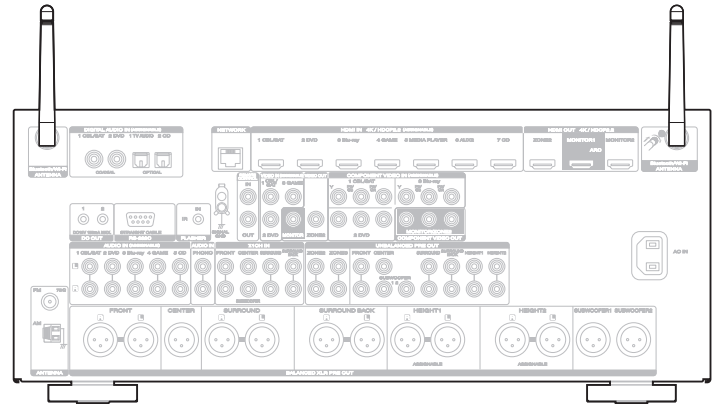

3) Connect the Pre Tuner to your TV with an HDMI cable

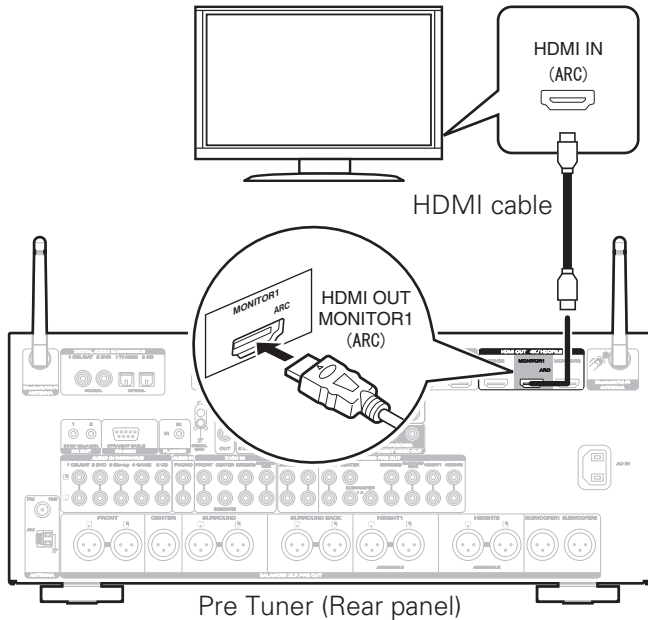

ARC (Audio Return Channel) :

If your TV supports ARC, your TV can send audio back to the Pre Tuner when you are using your TV's built-in video sources (TV tuner, Smart TV streaming services, etc...) ARC requires that you enable HDMI CEC on your TV. Please refer to your TV's Owner's Manual for instructions on how to setup HDMI CEC. Note that some TV manufacturers use other names for the HDMI CEC function.

4) Turn on the TV

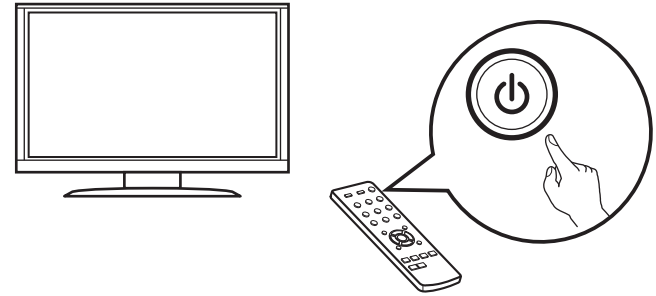

TV remote control unit

5) Select the appropriate HDMI input on your TV

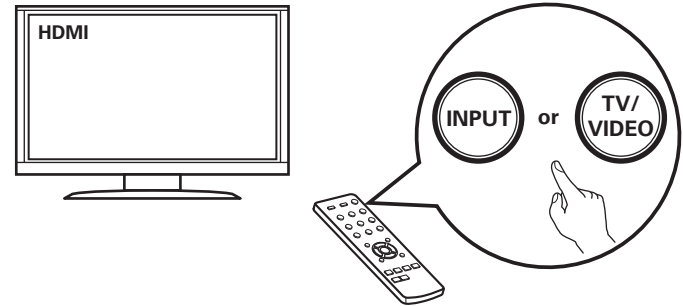

TV remote control unit

6) Turn on the Pre Tuner

- Press  to turn on the Pre Tuner.

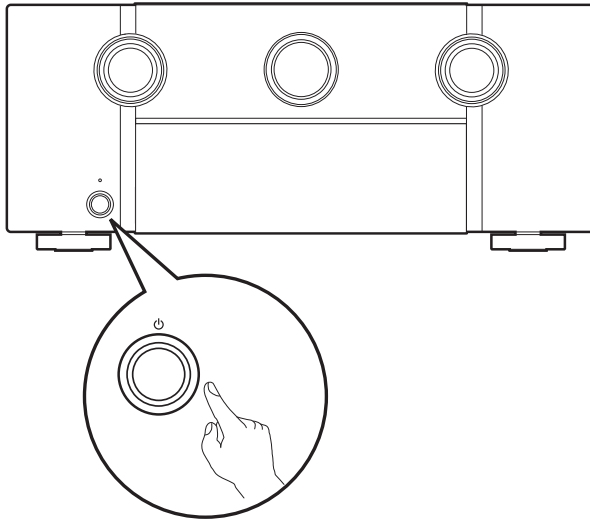

7) Verify the connection

- Verify that you can see this screen on your TV.

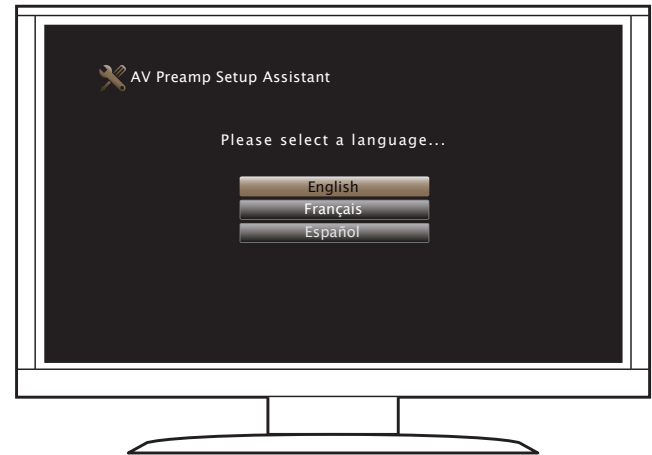

If this screen is not displayed, please go back and retry the steps again in the recommended sequence.

3 Following the On-Screen Setup Assistant

The Setup Assistant will walk you through connecting and configuring your Power Amplifier and components to your Marantz Pre Tuner. Please use the remote control and follow the on-screen instructions.

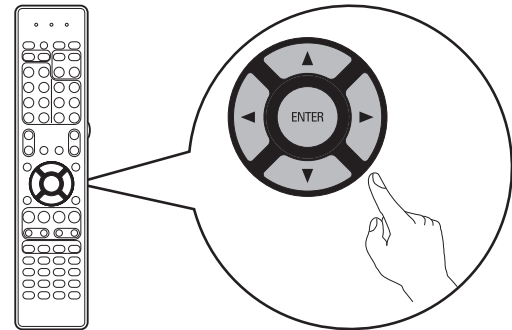
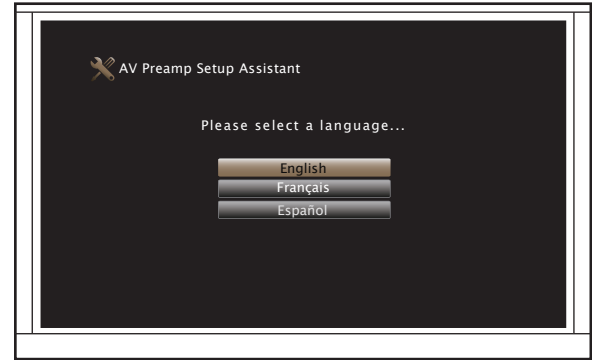

4 Downloading the Mobile Apps

Download both the “HEOS” App and the “Marantz 2016 AVR Remote” App for the full home entertainment experience. The HEOS App is required to access online music through your Pre Tuner.

HEOS



The HEOS App allows you to explore, browse, and play music from many online streaming services or from your own music library.



Marantz 2016 AVR Remote



Control your new Pre Tuner with the latest Marantz 2016 AVR Remote App. Volume control, sound mode selection and advanced settings are always only a tap away.



Owner's Manual

- For more information, visit www.marantz.com
- Refer to the Online Manual for other functions information and operation procedure details.
manuals.marantz.com/AV7704/NA/EN/

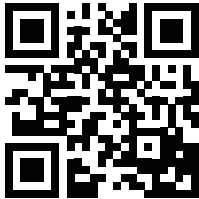

Online Manual

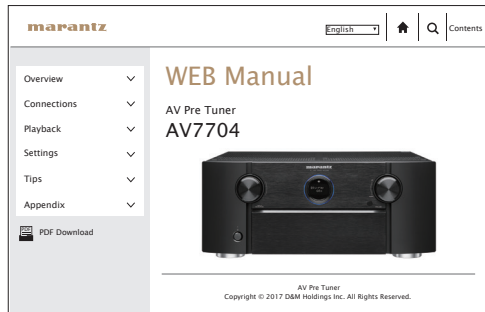

www.marantz.com

You can find your nearest authorized distributor or dealer on our website.

marantz[®] is a registered trademark.