



marantz®

AV Pre Tuner
AV7702mkII

Quick Start Guide

Kurzanleitung / Guide de démarrage rapide / Guida di Avvio Rapido /
Guía de inicio rápido / Snelhandleiding / Snabbstartsguide /
Краткое руководство пользователя / Skrócona instrukcja obsługi

Read Me First....

Bitte zuerst lesen... / Lisez-moi en premier.... / Nota preliminare.... /
Lea esto primero.... / Lees mij eerst... / Läs detta först... /
Прочитайте в первую очередь... / Przeczytaj to najpierw....

ENGLISH

DEUTSCH

FRANÇAIS

ITALIANO

ESPAÑOL

NEDERLANDS

SVENSKA

РУССКИЙ

POLSKI

Welcome

Thank you for choosing a Marantz Pre Tuner. This guide provides step-by-step instructions for setting up your Pre Tuner.

Please do not return this unit to the store – call for assistance.





If you need help... :

If you need additional help in solving problems, contact Marantz customer service in your area.

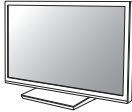

www.marantz.com

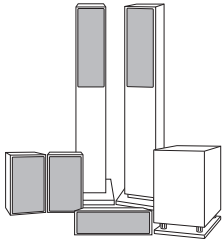
Before You Begin

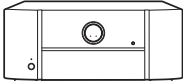
Required for Setup

 TV	 or  RCA cables XLR cables	 Speaker systems / Speaker cables
 HDMI cable	 Power amplifier	

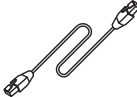













Optional

 LAN cable	or	 Wi-Fi router
--	----	---



- When connecting this unit to a device that is compatible with the Deep Color, 4K and ARC functions, use a “High Speed HDMI cable with Ethernet” that displays the HDMI logo.
- These drawings are for illustrative purposes only and may not represent the actual product(s).

What's In the Box

Quick Start Guide		FM indoor antenna	
Owner's Manual		AM loop antenna	
Safety Instructions		Sound calibration microphone	
Notes on radio		Sound calibration microphone stand	
Cable labels		Remote control unit	
Pre Tuner		R03/AAA batteries	
Power cord		External antennas for Bluetooth/wireless connectivity	



The supplied Sound calibration microphone stand is convenient for use when performing Speaker Calibration. Using your own tripod or the supplied Sound calibration microphone stand enables settings to be automatically configured to the optimum listening environment, providing exceptionally high performance.

Important: External Antennas

The removable external antennas are required for both Bluetooth and Wireless network connectivity. Please make sure to connect the antennas before attempting to use the Bluetooth or Wi-Fi features of the AV7702mkII.

❑ Connecting the external antennas for Bluetooth/Wireless connectivity

For each of the two antennas:

- ① Place the antenna evenly over the antenna terminal located at the upper left or right corner of the rear panel.
- ② Turn the antenna clockwise until it is fully connected. Do not over tighten.
- ③ Rotate the antenna upwards for the best possible reception.

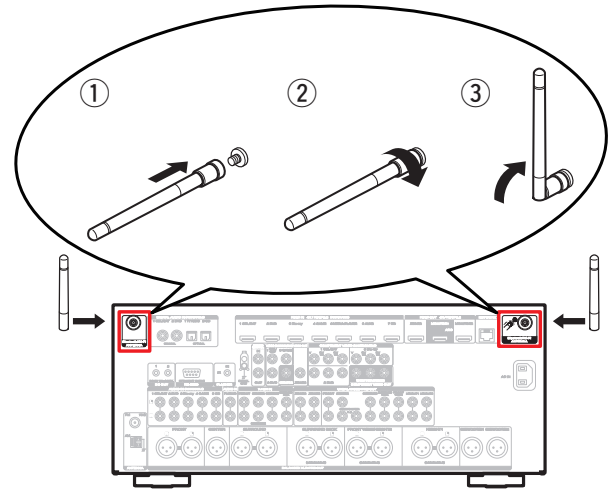

Setup

There are three steps to the setup process.

1 Installing batteries in the remote control unit

2 Connecting the Pre Tuner, Power Amplifier and your TV

3 Following the On-Screen Setup Assistant

1 Installing batteries in the remote control unit

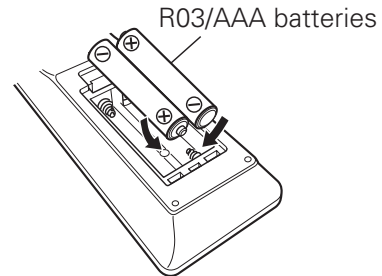
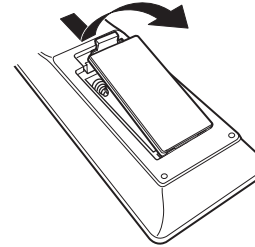

2 Connecting the Pre Tuner, Power Amplifier and your TV

2.1) Place the Pre Tuner and Power Amplifier near your TV and connect the power cord.

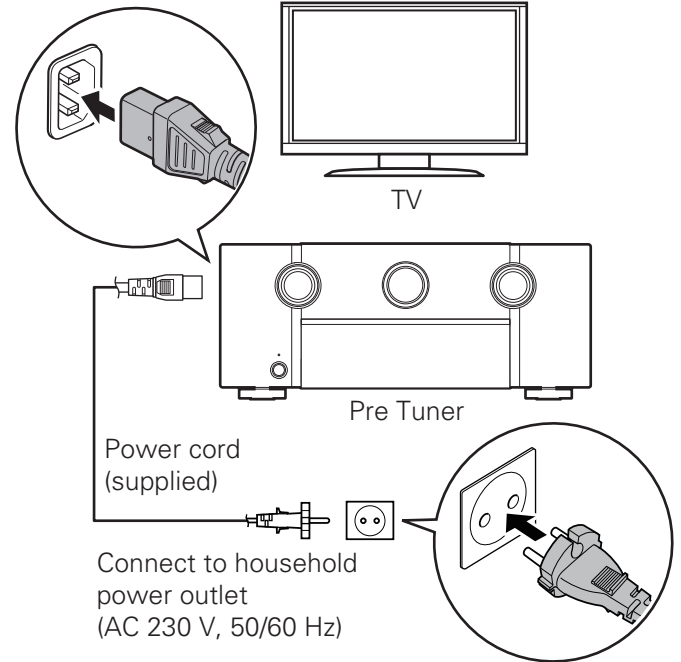
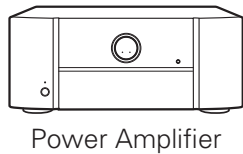
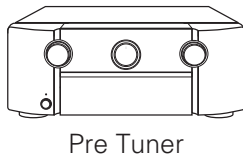
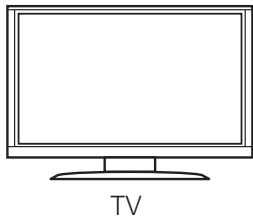

2.2) Connect to the network.

Wired LAN

When connecting cables (wired connection), connect a LAN cable between your Pre Tuner and your network router.

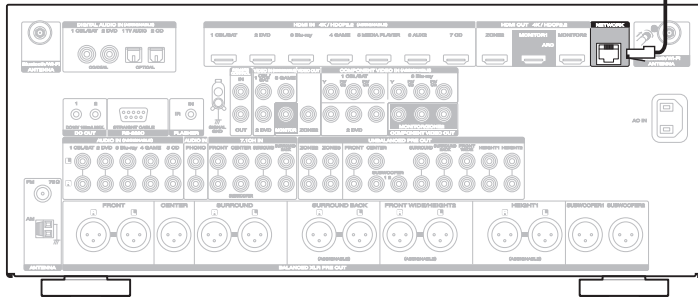
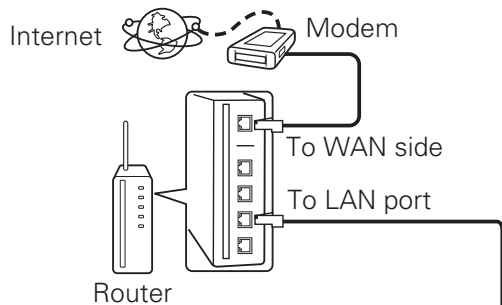

Wireless LAN

When connecting to wireless LAN (Wi-Fi), follow the instructions in "Connecting the external antennas for Bluetooth/Wireless connectivity" and connect the antennas.

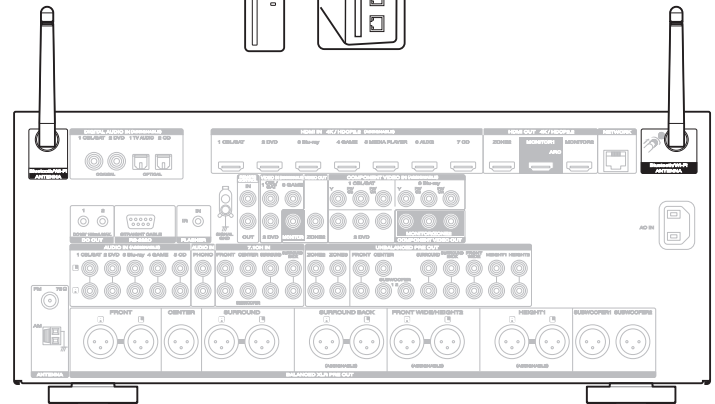
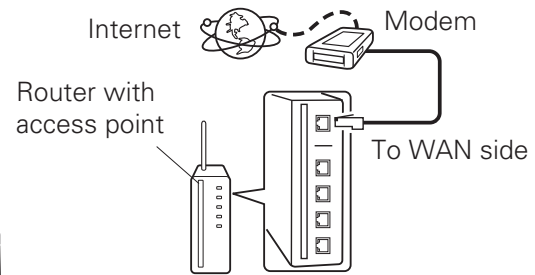

2.3) Connect the Pre Tuner to your TV with an HDMI cable.

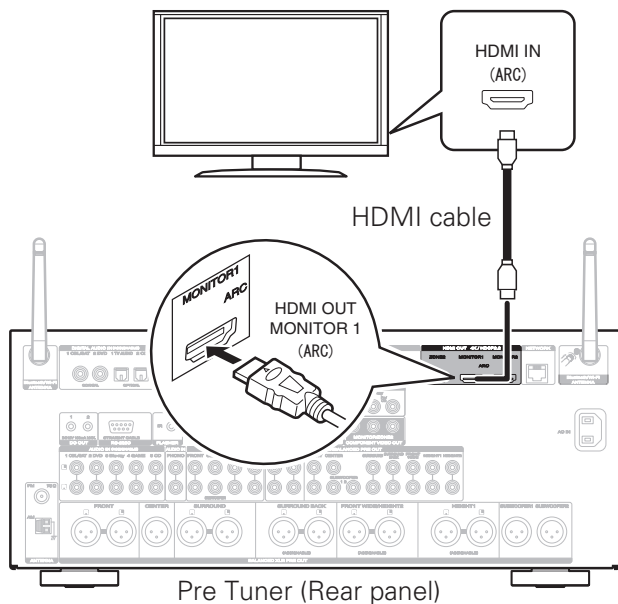

ARC (Audio Return Channel) :

If your TV supports ARC, your TV can send audio back to the AV pre tuner when you are using your TV's built-in video sources (TV tuner, Smart TV streaming services, etc...) ARC requires that you enable HDMI CEC on your TV. Please refer to your TV's Owner's Manual for instructions on how to setup HDMI CEC. Note that some TV manufacturers use other names for the HDMI CEC function.

2.4) Turn on the TV.

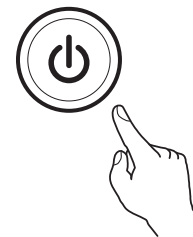
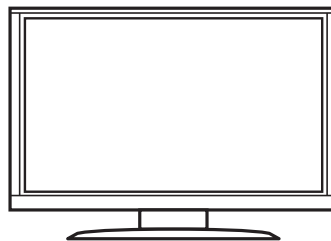

TV remote control unit

2.5) Select the appropriate HDMI input on your TV.

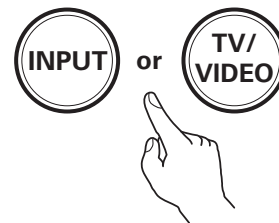

TV remote control unit

2.6) Turn on the Pre Tuner.

- Press  to turn on the Pre Tuner.

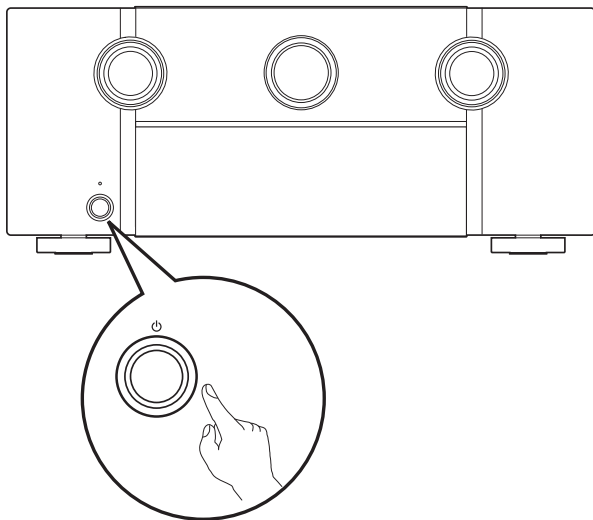

2.7) Verify the connection.

- Verify that you can see this screen on your TV.



If this screen is not displayed, please go back and retry the steps again in the recommended sequence.

3 Following the On-Screen Setup Assistant

The Setup Assistant will walk you through connecting and configuring your Power Amplifier and components to your Marantz Pre Tuner. Please use the remote control and follow the on-screen instructions.

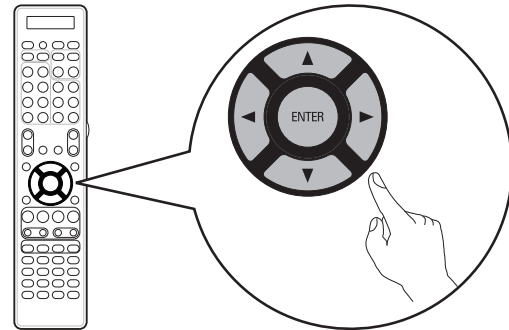

Owner's Manual

Please reference to the Owner's Manual for more details about the setup and operation of the Pre Tuner and its features.

❑ Online Version

Enter the following URL into your web browser:
manuals.marantz.com/AV7702MK2/EU/EN/



Online Manual

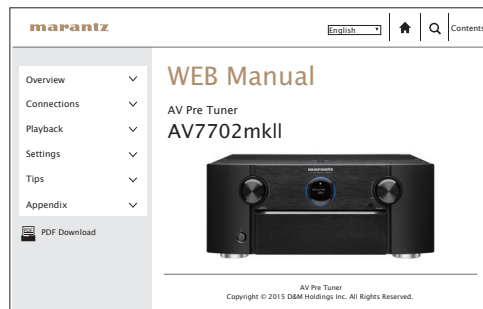

❑ Printable Version

Access the print version of the owner's manual from the included CD-ROM or select the "PDF Download" link from the Online Version.

1

Insert the disc into your PC.

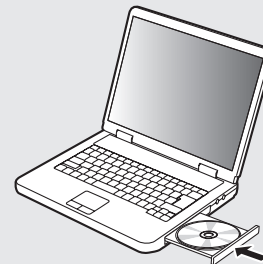

2

Follow the screen or double click on the PDF file.

www.marantz.com

You can find your nearest authorized distributor or dealer on our website.

marantz[®] is a registered trademark.