

marantz®

Model SR4200 User Guide

AV Surround Receiver

ENGLISH

WARRANTY

For warranty information, contact your local Marantz distributor.

RETAIN YOUR PURCHASE RECEIPT

Your purchase receipt is your permanent record of a valuable purchase. It should be kept in a safe place to be referred to as necessary for insurance purposes or when corresponding with Marantz.

IMPORTANT

When seeking warranty service, it is the responsibility of the consumer to establish proof and date of purchase. Your purchase receipt or invoice is adequate for such proof.

FOR U.K. ONLY

This undertaking is in addition to a consumer's statutory rights and does not affect those rights in any way.

FRANÇAIS

GARANTIE

Pour des informations sur la garantie, contacter le distributeur local Marantz.

CONSERVER L'ATTESTATION D'ACHAT

L'attestation d'achat est la preuve permanente d'un achat de valeur. La conserver en lieu sûr pour s'y reporter aux fins d'obtention d'une couverture d'assurance ou dans le cadre de correspondances avec Marantz.

IMPORTANT

Pour l'obtention d'un service couvert par la garantie, il incombe au client d'établir la preuve de l'achat et d'en corroborer la date. Le reçu ou la facture constituent des preuves suffisantes.

DEUTSCH

GARANTIE

Bei Garantiefragen wenden Sie sich bitte an Ihren Marantz-Händler.

HEBEN SIE IHRE QUITTING GUT AUF

Die Quittung dient Ihnen als bleibende Unterlage für Ihren wertvollen Einkauf. Das Aufbewahren der Quittung ist wichtig, da die darin enthaltenen Angaben für Versicherungswecke oder bei Korrespondenz mit Marantz angeführt werden müssen.

WICHTIG!

Bei Garantiefragen muß der Kunde eine Kaufunterlage mit Kaufdatum vorlegen. Ihren Quittung oder Rechnung ist als Unterlage ausreichend.

NEDERLANDS

GARANTIE

Voor inlichtingen omtrent garantie dient u zich tot uw plaatselijke Marantz.

UW KWITANTIE, KASSABON E.D. BEWAREN

Uw kwitantie, kassabon e.d. vormen uw bewijs van aankoop van een waardevol artikel en dienen op een veilige plaats bewaard te worden voor evt. verwijzing bijv. in verbend met verzekering of bij correspondentie met Marantz.

BELANGRIJK

Bij een evt. beroep op de garantie is het de verantwoordelijkheid van de consument een gedateerd bewijs van aankoop te tonen. Uw kassabon of factuur zijn voldoende bewijs.

ESPAÑOL

GARANTIA

Para obtener información acerca de la garantía póngase en contacto con su distribuidor Marantz.

GUARDE SU RECIBO DE COMPRA

Su recibo de compra es su prueba permanente de haber adquirido un aparato de valor. Este recibo deberá guardarlo en un lugar seguro y utilizarlo como referencia cuando tenga que hacer uso del seguro o se ponga en contacto con Marantz.

IMPORTANTE

Quando solicitar el servicio otorgado por la garantía el usuario tiene la responsabilidad de demostrar cuándo efectuó la compra. En este caso, su recibo de compra será la prueba apropiada.

ITALIANO

GARANZIA

L'apparecchio è coperto da una garanzia di buon funzionamento della durata di un anno, o del periodo previsto dalla legge, a partire dalla data di acquisto comprovata da un documento attestante il nominativo del Rivenditore e la data di vendita. La garanzia sarà prestata con la sostituzione o la riparazione gratuita delle parti difettose.

Non sono coperti da garanzia difetti derivanti da uso improprio, errata installazione, manutenzione effettuata da personale non autorizzato o, comunque, da circostanze che non possano riferirsi a difetti di funzionamento dell'apparecchio. Sono inoltre esclusi dalla garanzia gli interventi inerenti l'installazione e l'allacciamento agli impianti di alimentazione.

Gli apparecchi verranno riparati presso i nostri Centri di Assistenza Autorizzati. Le spese ed i rischi di trasporto sono a carico del cliente.

La casa costruttrice declina ogni responsabilità per danni diretti o indiretti provocati dalla inosservanza delle prescrizioni di installazione, uso e manutenzione dettagliate nel presente manuale o per guasti dovuti ad uso continuato a fini professionali.

PORTUGUÊS

GARANTIA

Para informações sobre a garantia, contactar o distribuidor Marantz local.

GUARDAR O RECIBO DE COMPRA

O recibo é o registo permanente da compra que fez. Deve ser guardado num local seguro, para ser apresentado em questões relacionadas com o seguro ou para quando tiver de contactar a Marantz.

IMPORTANTE

Quando procurar assistência técnica ao abrigo da garantia, é da responsabilidade do consumidor estabelecer a prova e data de compra.

O recibo é prova adequada.

SVENSKA

GARANTI

För information om garantin, kontakta Marantz lokalgagent.

SPAR KVITTOT

Kvittot är ett inköpsbevis på en värdefull vara. Det skall förvaras säkert och hänvisas till vid försäkringsfall eller vidkorrespondens med Marantz.

VIKTIGT

Fö att garantin skall gälla är det kundens sak att framställa bevis och datum om köpet. Kvitto eller faktura är tillräckligt bevis för detta.

DANSK

GARANTI

Henvend dem til Deres MARANTZ-forhandler angående information om garantien.

GEM DERES KVITTERING

Deres købskvittering er Deres varige bevis på et dyrt køb. Den bør gemmes godt og anvendes som bevis, hvis De vil tegne en forsikring, eller hvis De kommunikerer med Marantz.

VIGTIGT

Det påhviler forbrugeren at skaffe bevis for købet og købsdatoen, hvis han eller hun ønsker garantiservice. Deres købskvittering eller faktura er et fuldgældigt bevis herpå.

CE MARKING

- English**
The SR4200 is in conformity with the EMC directive and low-voltage directive.
- Français**
Le SR4200 est conforme à la directive EMC et à la directive sur les basses tensions.
- Deutsch**
Das Modell SR4200 entspricht den EMC-Richtlinien und den Richtlinien für Niederspannungsgeräte.
- Nederlands**
De SR4200 voldoet aan de EMC eisen en de vereisten voor laag-voltage.
- Español**
El SR4200 está de acuerdo con las normas EMC y las relacionadas con baja tensión.
- Italiano**
Il SR4200 è conforme alle direttive CEE ed a quelle per i bassi voltaggi.
- Português**
O SR4200 conforma com as diretrizes EMC e de baixa voltagem.
- Svenska**
SR4200 är tillverkad i enlighet med EMC direktiven och direktiven för lågvoltsutrusning.
- Dansk**
Model SR4200 er i overensstemmelse med EMC-direktivet og direktivet om lavspænding.

English

To ventilate the unit, do not install the unit in a rack or bookshelf, and note the followings.

- Do not touch the top of the enclosure during operation.
- Do not block the openings in the enclosure during operation.
- Do not insert objects beneath the unit.
- Do not block the ventilation slots at the top of the unit.
- Do not place anything about 1 meter above the top panel.
- Make a space of about 0.2 meter around the unit.

Français

Pour que l'appareil puisse être correctement ventilé, ne pas l'installer dans un meuble ou une bibliothèque et respecter ce qui suit.

- Ne pas toucher le dessus du coffret.
- Ne pas obstruer les ouïes de ventilation du coffret pendant le fonctionnement.
- Ne placer aucun objet sous l'appareil.
- Ne pas obstruer les ouïes de ventilation du panneau supérieur. Ne placer aucun objet à moins d'un mètre environ du panneau supérieur.
- Veiller à ce qu'aucun objet ne soit à moins de 0,2 mètre des côtés de l'appareil.

Deutsch

Um eine einwandfreie Belüftung des Geräts zu gewährleisten, darf das Gerät nicht in einem Gestell oder Bücherregal aufgestellt werden; die folgenden Punkte sind besonders zu beachten:

- Während des Betriebs das Oberteil des Gehäuses nicht berühren.
- Während des Betriebs die Öffnungen im Gehäuse nicht blockieren.
- Keine Gegenstände in das Gerät einführen.
- Die Belüftungsschlitze an der Oberseite des Geräts dürfen nicht blockiert werden. Darauf achten, daß über dem Gerät ein Freiraum von mindestens 1 meter vorhanden ist.
- Auf allen Geräteseiten muß ein Zwischenraum von ungefähr 0,2 meter vorhanden sein.

Nederlands

Installeer het toestel niet in een rek of boekenkast waar de ventilatie mogelijk wordt gehinderd. Let tevens op de volgende punten:

- Raak de bovenkant van het toestel niet aan als het in gebruik is.
- Blokkeer de openingen van het toestel niet als het in gebruik is.
- Plaats geen onderwerpen onder het toestel.
- Blokkeer de ventilatie-openingen aan de bovenkant van het toestel niet. Zorg dat er tenminste 1 meter vrije ruimte boven het toestel is.
- Zorg dat er 0,2 meter vrije ruimte rond het toestel is.

Español

Para ventilar la unidad no la instale en una estantería ni estante para libros, y tenga en cuenta lo siguiente:

- No toque la parte superior de la caja durante el funcionamiento.
- No tape las ranuras en la caja durante el funcionamiento.
- No ponga objetos debajo de la unidad.
- No tape las ranuras de ventilación de la parte superior de la unidad. No ponga nada a menos de 1 metro por encima del panel superior.
- Deje un espacio de unos 0,2 metro alrededor de la unidad.

Italiano

Perché l'unità possa essere sempre ben ventilata, non installarla in scaffali o librerie e tenere presente quanto segue.

- Non toccare la parte superiore del rivestimento durante il funzionamento.
- Non bloccare le aperture sul rivestimento durante il funzionamento.
- Non inserire oggetti al di sotto dell'unità.
- Non bloccare le fessure di ventilazione sopra l'unità. Non posare nulla per circa un metro sopra il pannello superiore.
- Lasciare 0,2 metro liberi tutto intorno l'unità.

Português

Para ventilar o aparelho, não instalá-lo dentro duma estante ou algo similar, e observar as seguintes recomendações:

- Não tocar a parte superior do aparelho durante a operação.
- Não bloquear as aberturas do aparelho durante a operação.
- Não inserir objectos debaixo do aparelho.
- Não bloquear as aberturas de ventilação na parte de cima do aparelho. Deixar um espaço completamente livre de cerca de 1 metro acima do painel superior.
- Deixar um espaço de cerca de 0,2 metro ao redor do aparelho.

Svenska

För att ventilera enheten, ställ den inte i ett ställ eller bokhylla och tänk på följande.

- Vidrör inte ytterhöljets ovansida under pågående drift.
- Blockera inte öppningarna i ytterhöljet under pågående drift.
- Stick inte in föremål under enheten.
- Blockera inte ventilationshålen ovanpå enheten. Placera inte någonting närmare än 1 meter ovanför apparaten eller enheten.
- Se till att det finns omkring 0,2 meter fri plats runt omkring enheten.

Dansk

Anbring ikke apparatet i et rack eller en boghylde, da dette kan bloke luftcirkulationen omkring apparatet. Iagttag ligeledes følgende:

- Berør ikke oversiden af kabinettet under anvendelsen.
- Bloker ikke åbningerne i kabinettet under anvendelsen.
- Stik ikke genstande ind under apparatet.
- Bloker ikke ventilationsåbningerne ovenpå apparatet. Anbring ikke noget nærmere end 1 m over apparatets overside.
- Sørg for, at der er et frit område på omkring 0,2 m omkring apparatet.

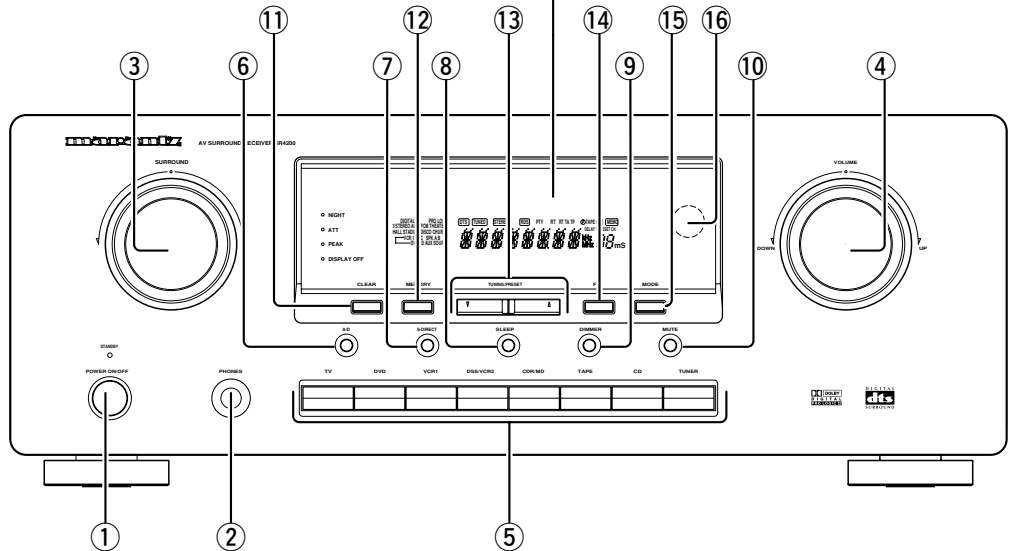
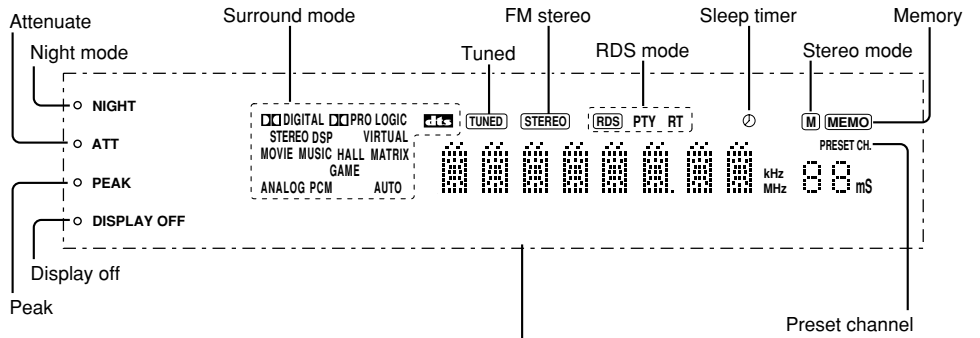
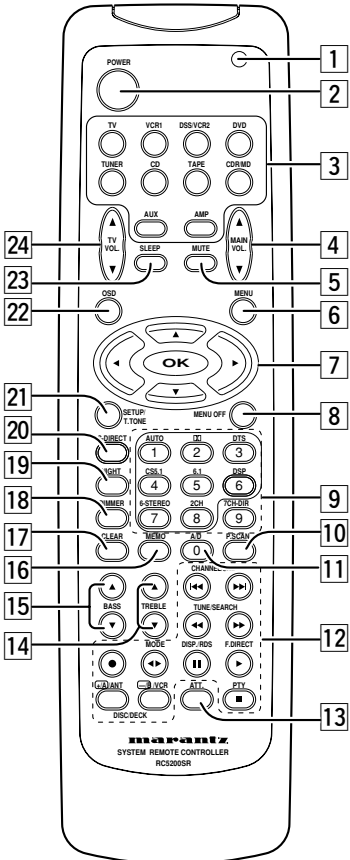
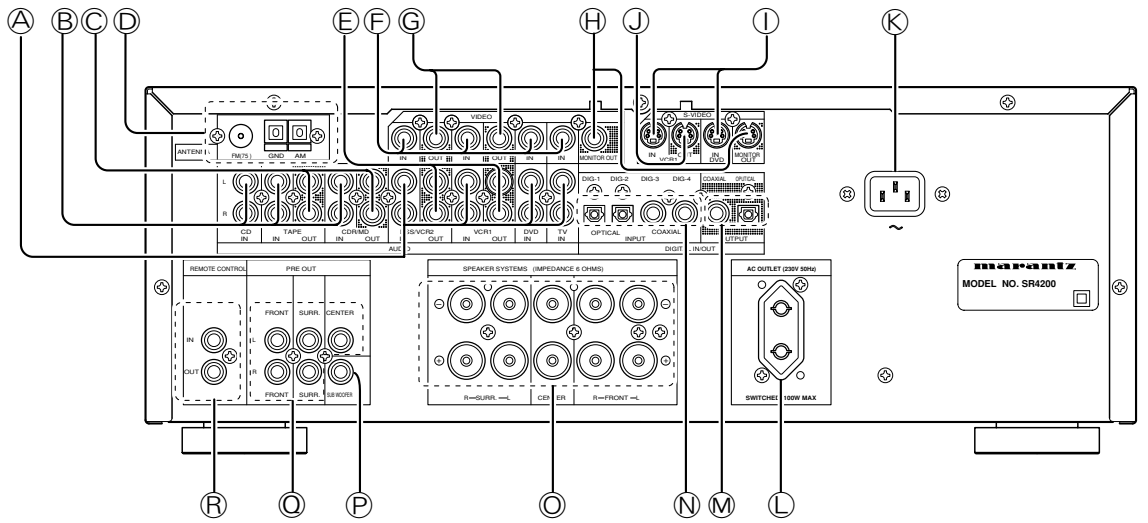

VIDEO SYSTEM CONNECTIONS FOR VIDEO COMPONENTS

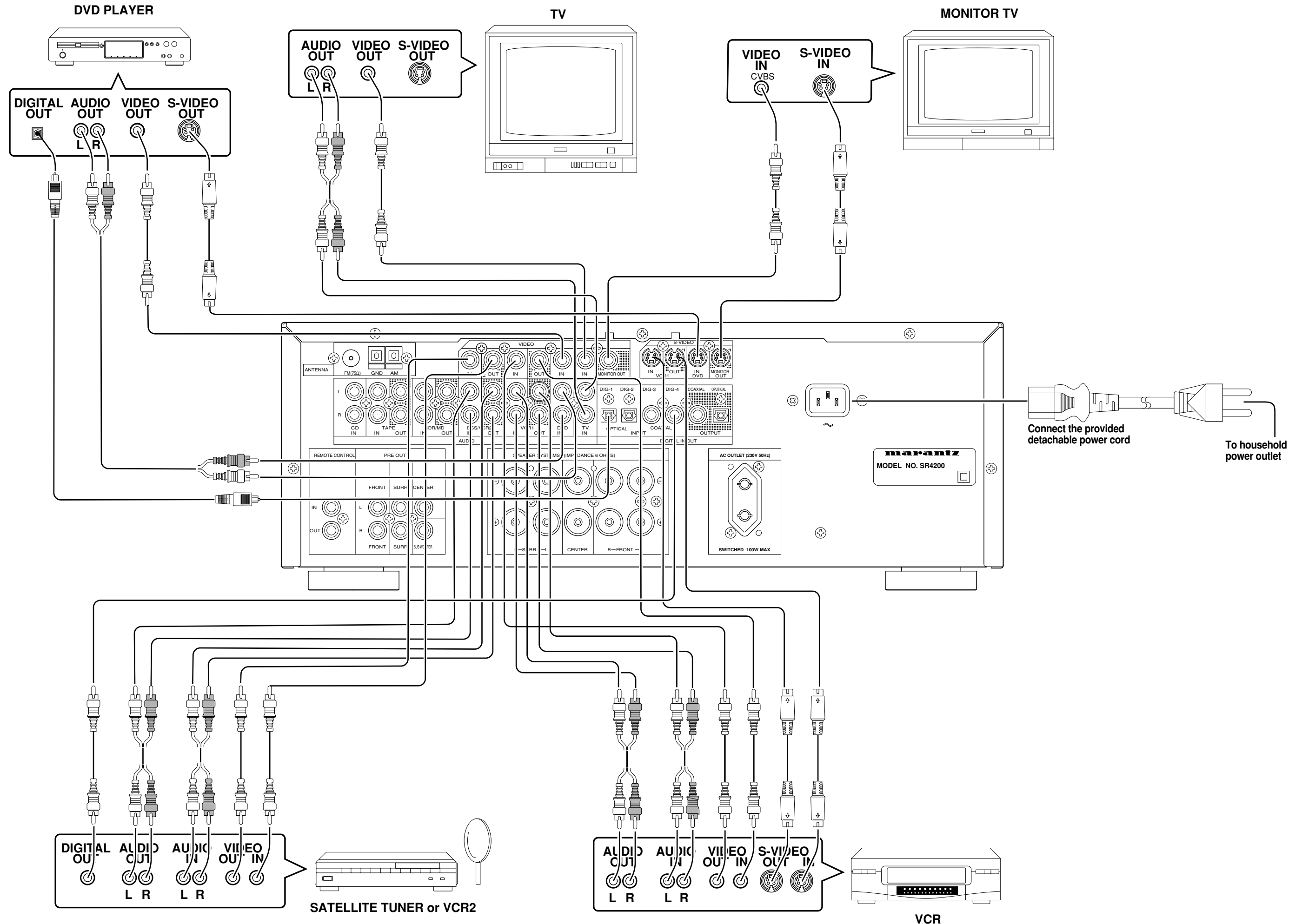

AUDIO SYSTEM CONNECTIONS FOR AUDIO COMPONENTS

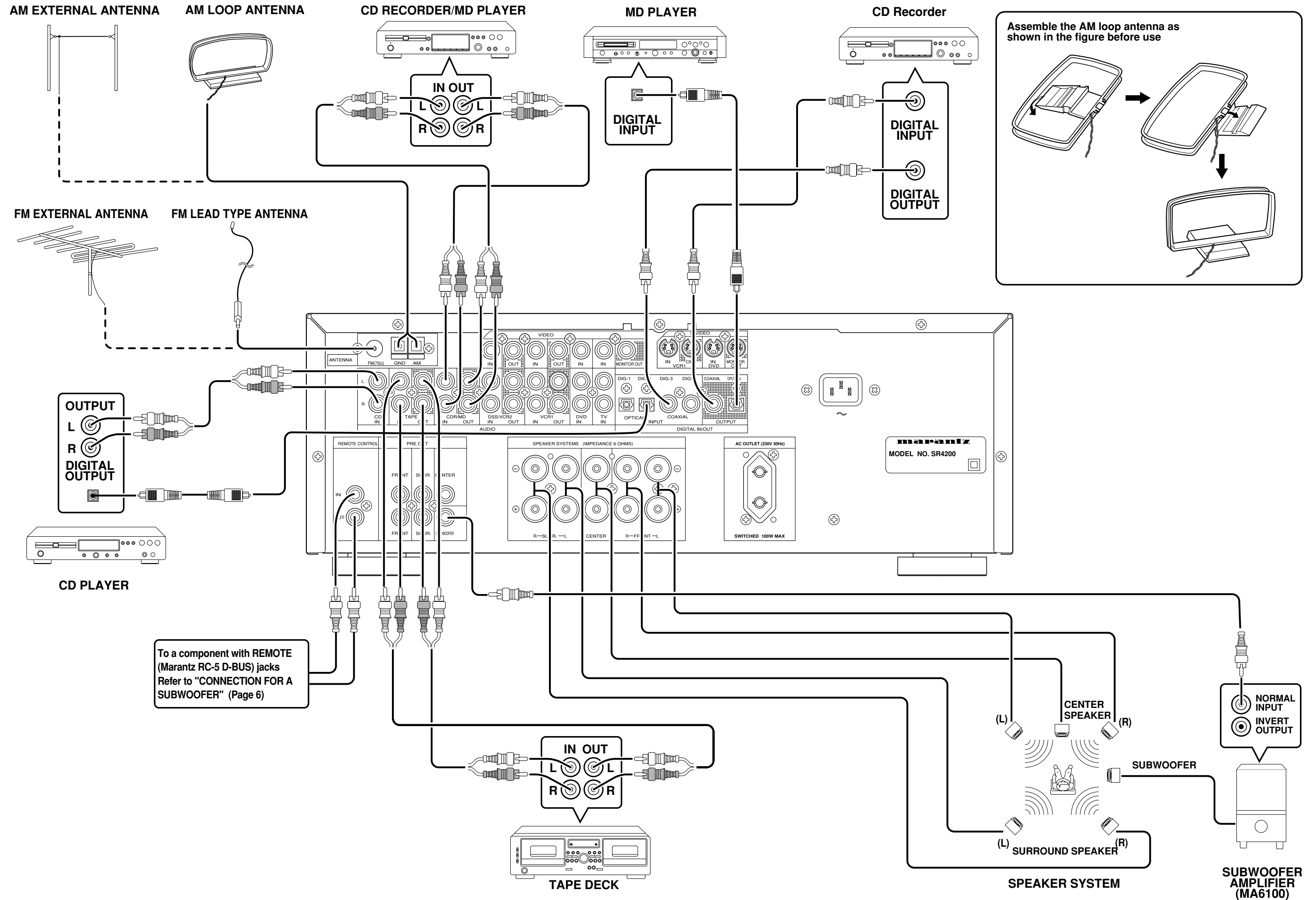

TABLE OF CONTENTS

FOREWORD	2
INTRODUCTION	3
DESCRIPTION	3
FEATURES	3
FRONT PANEL FEATURES	4
REAR PANEL CONNECTIONS	5
REMOTE CONTROL OPERATION	7
OPERATION	7
FUNCTION AND OPERATION	7
PROGRAMMING THE REMOTE CONTROLLER	8
OPERATION OF REMOTE CONTROL UNIT	9
SET-UP	10
MENU FUNCTION	10
MENU STRUCTURE	10
SYSTEM SETUP	11
SPEAKERS SETUP	11
TEST MODE	12
BASIC OPERATION	13
LISTENING TO THE TUNER	13
RDS OPERATION	14
PLAYBACK OPERATION	15
SETTING THE SLEEP TIMER	15
SURROUND MODES	16
TROUBLE SHOOTING	18

FOREWORD

This section must be read before any connection is made to the mains supply.

WARNINGS

Do not expose the equipment to rain or moisture.
Do not remove the cover from the equipment.
Do not push anything inside the equipment through the ventilation holes.
Do not handle the mains lead with wet hands.

EQUIPMENT MAINS WORKING SETTING

Your Marantz product has been prepared to comply with the household power and safety requirements that exist in your area. SR4200 can be powered by 230 V AC only.

IMPORTANT: (For UK version)

This apparatus is fitted with an approved moulded 13 Amp plug. To change a fuse in this type of plug proceed as follows:

1. Remove fuse cover and fuse.
2. Fix new fuse which should be a BS1362 13A, A.S.T.A. or BSI approved type.
3. Refit the fuse cover.

If the fitted plug is not suitable for your socket outlets, it should be cut off and an appropriate plug fitted in its place.

If the mains plug contains a fuse, this should have a value of 13A. If a plug without a fuse is used, the fuse at the distribution board should not be greater than 5A.

Note:

The severed plug must be destroyed to avoid a possible shock hazard should it be inserted into a 13A socket elsewhere.

How to connect a plug

The wires in the mains lead are coloured in accordance with the following code:

BLUE—"NEUTRAL" ("N")

BROWN—"LIVE" ("L")

1. The BLUE wire must be connected to the terminal which is marked with the letter "N" or coloured BLACK.
2. The BROWN wire must be connected to the terminal which is marked with the letter "L" or coloured RED.
3. Do not connect either wires to the earth terminal in the plug which is marked by the letter "E" or by the safety earth symbol or coloured green or green-and-yellow.

Before replacing the plug cover, make certain that the cord grip is clamped over the sheath of the lead — not simply over the two wires.

COPYRIGHT

Recording and playback of any material may require consent. For further information refer to the following:

- Copyright Act 1956
- Dramatic and Musical Performers Act 1958
- Performers Protection Acts 1963 and 1972
- any subsequent statutory enactments and orders

ABOUT THIS USER GUIDE

Refer to the figures on page iii of this user guide. The numbers on the figures correspond to those in the text. All references to the connections and controls that are printed in **BOLD** type are as they appear on the unit.

PRECAUTIONS

The following precautions should be taken when operating the equipment.

GENERAL PRECAUTIONS

When siting the equipment ensure that:

- the ventilation holes are not covered;
- air is allowed to circulate freely around the equipment
- it is on a vibration free-surface;
- it will not be exposed to interference from an external source;
- it will not be exposed to excessive heat, cold, moisture or dust;
- it will not be exposed to direct sunlight;
- it will not be exposed to electrostatic discharges

Never place heavy objects on the equipment.

If a foreign body or water does enter the equipment, contact your nearest dealer or service centre.

Do not pull out the plug by pulling on the mains lead, hold the plug.

It is advisable when leaving the house, or during a thunderstorm, to disconnect the equipment from the mains supply.

PRECAUTIONS IN CONNECTION

- Be sure to unplug the power cable from the AC outlet or turn off the POWER switch before proceeding with any connection.
- Connect one cable at a time observing the "input" and "output".
This will avoid any cross connection between channels and signal inputs and outputs.
- Insert the plugs securely. Incomplete connection may result in noise.
- Prior to connecting other audio and video equipment to the SR4200, please read their owner's manuals.

INSTALLATION

If this unit or another electronic device incorporating a microcomputer is used at the same time with the tuner or television, picture disturbance or noise may occur. In such a case, install the unit according to the following guide points.

- Separate the unit as far as possible from the television.
- Place the antenna wire for the tuner or TV apart from the power cable and audio and video connection cables of this unit.
- Since the phenomenon is likely to occur when using an indoor antenna and/or 300-ohm feeder wire, we recommend using an outdoor antenna and 75-ohm coaxial cable.

INTRODUCTION

Thank you for purchasing the Marantz SR4200 DTS/Dolby Digital Surround receiver.

This remarkable component has been engineered to provide you with many years of home theater enjoyment.

Please take a few minutes to read this manual thoroughly before you connect and operate the SR4200.

As there are a number of connection and configurations options, you are encouraged to discuss your own particular home theater setup with your Marantz A/V specialist dealer.

DESCRIPTION



DTS was introduced in 1994 to provide 5.1 channels of discrete digital audio into home theater systems.

DTS brings you premium quality, discrete multi-channel digital sound to both movies and music.

DTS is a multi-channel sound system designed to create full range digital sound reproduction.

The no compromise DTS digital process sets the standard of quality for cinema sound by delivering an exact copy of the studio master recordings to neighborhood and home theaters.

Now, every moviegoer can hear the sound exactly as the moviemaker intended.

DTS can be enjoyed in the home for either movies or music on DVD's, LD's and CD's.



Dolby Digital lets you enjoy Digital TV, Digital Satellite as well as DVD, LD software in digital surround, which is the next step above Dolby Pro Logic.

In Comparison with Dolby Pro Logic, Dolby Digital can provide separate left surround and right surround channels, for more precise localization of sound and a more convincing, realistic ambience.

And, with Dolby Digital all five main channels can be full ranged and a subwoofer can be added to each channel, if desired.

By providing up to 5.1 channels of digital audio independently. Dolby Digital lets you enjoy better sound quality and more powerful presence than conventional Dolby Surround.

Pro Logic II, the next generation in Dolby Surround Pro Logic technology, brings the excitement of surround sound to any existing stereo mix, while making existing Dolby Surround mixes sound more like discrete 5.1-channel surround sound. It works with CDs, VHS tapes and TV shows, and MP3 files and radio broadcasts-converting all of these source to surround sound, without the artifacts by other matrix-decoding technologies.

"Dolby", "Pro Logic", and the double-D symbol are trademarks of Dolby Laboratories. Confidential unpublished works.

"DTS" and "DTS Digital Surround" are registered trademarks of Digital Theater Systems, Inc.

FEATURES

- Dolby Digital and DTS surround sound decoding, plus Dolby Pro Logic II decoding and a variety of additional surround modes.
- 96 kHz/ 24 bit decoding for highest possible fidelity and bandwidth, and high-resolution playback of 96 kHz/ 24 bit PCM audio sources.
- 70 watts to each of the five main channels; the power amp section features advanced, premium high-storage power supply capacitors, and fully discrete output stages housed in cast aluminum heat sinks.
- 5.1 channel pre-amp outputs for connection to external components such as a subwoofer and external power amplifiers.
- 2 Digital outputs for connection to CD-R or MD.
- High-quality AM (MW/LW) /FM tuner with 50 station presets.
- Source Direct switch bypasses, tone controls and bass management for purest sound quality.
- S-video and composite video switch.
- Radio Data System (RDS) provides information on FM broadcasts.

FRONT PANEL FEATURES (SEE PAGE iii.)

① POWER switch and STANDBY indicator

Press the button to turn the power ON, and press again to turn it OFF. If the **POWER** switch is in the ON position, the power of this unit can be turned ON/OFF by pressing the **POWER** button on the remote control unit.

When this unit is in the standby mode with the **POWER** switch set to the ON position, pressing one of the **FUNCTION SELECTOR** buttons also allows to turn the power on.

The **STANDBY** indicator lights up when this unit is the standby mode (power OFF) by the remote control unit.

② PHONES jack for stereo headphones

Conventional dynamic headphones can be plugged in here.

Notes:

When using headphones, the surround mode is switched automatically to STEREO and the sound from the speakers is muted.

The surround mode returns to the previous setting as soon as the plug is removed from the jack.

③ SURROUND MODE Selector knob

When this knob is turned, the surround mode is switched in the following sequence.

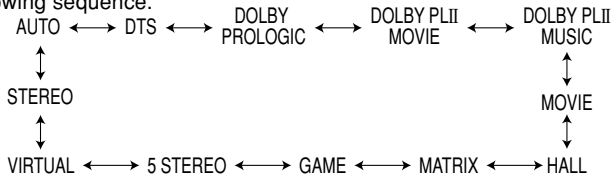

Note:

Not all modes will be present if an analog input is selected.

④ VOLUME control knob

Adjusts the overall sound level. Turning the control clockwise increases the sound level.

⑤ FUNCTION SELECTOR buttons (AUDIO/VIDEO)

These buttons are used to select the sources.

The video function selector, such as TV, DVD, VCR1 and DSS/VCR2, selects video and audio simultaneously.

⑥ A/D (Analog/Digital) SELECTOR button

This is used to select between the analog and/or digital inputs.

When analog input is selected, "ANALOG" will be shown in the display.

Note:

This button is not used for an input source that is not connected to a digital input.

⑦ S. (Source) DIRECT button

When this button is pressed, the tone control circuit is bypassed as well as Bass Management.

Notes:

The surround mode is automatically switched to AUTO when the source direct function is turned on.

Additionally, Speaker Configurations are fixed automatically as follow.

Front speaker = Large

Center speaker = Large

Surround speaker = Large

Sub woofer = Yes

⑧ SLEEP button

Set the sleep timer function with this button.

⑨ DIMMER (Display off) button

When this button is pressed once, the display is dimmed.

When this button is pressed twice, the display is turned off and the "DISPLAY OFF" indicator lights up.

Press this button again to turn the display ON again.

⑩ MUTE button

Press this button to mute the output to the speakers. Press it again to return to the previous volume level.

⑪ CLEAR button

Press this button to cancel the station memory setting mode or preset scan tuning.

⑫ MEMORY button

Press this button to enter the tuner preset memory numbers and station names.

⑬ TUNING / PRESET UP and DOWN buttons

During reception of AM (MW/LW) or FM, you can scan the other frequencies or select another preset station pressing these buttons.

⑭ FREQUENCY / PRESET button

During reception of AM (MW/LW) or FM, you can change the function of the UP/DOWN buttons for scanning frequencies or selecting preset stations by pressing this button.

⑮ MODE button

Press this button to select the auto stereo mode or mono mode when the FM band is selected. The **M** indicator lights in the auto stereo mode.

⑯ INFRARED SENSOR window

This window receives infrared signals from the remote control unit.

REAR PANEL CONNECTIONS (SEE PAGE iii.)

All connections to the rear panel should be made with the entire system powered off.

To avoid errors, it is advisable to connect one cable at a time between the various components.

Ⓐ Analog audio inputs for video source equipment

TV, DVD, VCR1, and DSS/VCR2

Connect each input to the audio outputs of your video source equipment.

Ⓑ Analog audio inputs

CD, TAPE, and CD-R/MD

Connect the audio outputs of your source components to the input jacks on the receiver.

Ⓒ Analog audio outputs for audio source equipment

TAPE and CD-R/MD

Connect each output to the audio inputs (REC in) of your recording equipment.

Ⓓ FM antenna terminal (75 ohms)

Connect an external FM antenna with a coaxial cable, or a cable network FM source.

AM antenna and ground terminals

Connect the supplied AM loop antenna. Use the terminals marked "AM" and "GND".

The supplied AM loop antenna will provide good AM reception in most areas.

Position the loop antenna until you hear the best reception.

Ⓔ Analog audio outputs for video source equipment

VCR1, and DSS/VCR2

Connect each output to the audio inputs (REC in) of your video recording equipment.

Ⓕ Video inputs

TV, DVD, VCR1, and DSS/VCR2

Connect each input to the video outputs of your video source equipment.

Ⓖ Video outputs

VCR1, and DSS/VCR2

Connect each output to the video input (REC in) of your video recording equipment.

Ⓗ TV MONI. (VIDEO/S-VIDEO) output jacks

Connect the TV MONI jack to your TV's video input (VIDEO IN) jack. You can connect your video equipment with S-VIDEO jacks if possible, or the composite VIDEO jacks.

You must use the same type of connection from your video player into the receiver, and out of the receiver into your TV.

Both must be composite video or both must be S-Video. You cannot convert a signal from one type to the other.

Ⓙ S-video inputs

DVD and VCR1

Connect each input to the S-video outputs of your video source equipment.

⓵ S-video outputs

VCR1

Connect each output terminals to S-video input (REC in) of your video recording equipment.

⓶ AC INLET

Connect to supplied AC cable, and connect to AC power outlet. SR4200 can be powered by 230V AC only.

⓷ AC OUTLET

Connect the power cables of components such as a DVD or CD player to this outlet.

Caution:

In order to avoid potential turn-off thumps, anything plugged in here should be powered up BEFORE the SR4200 is turned on.

⓸ DIGITAL outputs

Optical and Coaxial

Connect digital input of your digital recording equipment.

⓹ DIGITAL inputs

Fig.1, 2 (Optical) and Fig.3, 4 (Coaxial)

Connect each input to the digital output of your equipment.

Use the system setup menu to assign digital input to appropriate source. (see page. 11)

Note :

Do not connect for LD player's RF out, If you want to decode this type of signal, an external demodulator must be used.

⓺ SPEAKER terminals

FRONT Left & Right speakers output terminals

Connect to the front left & right speakers.

CENTER speaker output terminals

Connect to the center speaker.

SURROUND Left & Right speakers output terminals

Connect to the surround (rear) left & right speakers.

⓻ SUB WOOFER output jack

Connect to the input jack(s) of the power amplifier for subwoofer channel or powered subwoofer.

⓼ PRE OUT jacks

Jacks for Front - L/R, Center and Surround.

Use these jacks for connection to an external power amplifier.

⓽ REMOTE CONT. IN/OUT terminals

Connect to a Marantz component equipped with remote control (RC-5) terminals.

REMOTE CONTROL BUS CONNECTIONS

This unit is equipped with a remote control function. By connecting this unit's remote control jacks to a Marantz CD player or tape deck equipped with remote control (RC-5) jacks, it allows system remote control to operate. Connect **RCREMOTE CONTROL OUT** jack of SR4200 to REMOTE CONTROL. IN of other Marantz equipment, i.e. CD player or tape deck, by using an RCA pin cable.

Note:
If a component equipped with remote control (RC-5) jacks has an INT/EXT switch on the rear panel, set the switch to EXT when using the system control function with SR4200.

(Connection example)

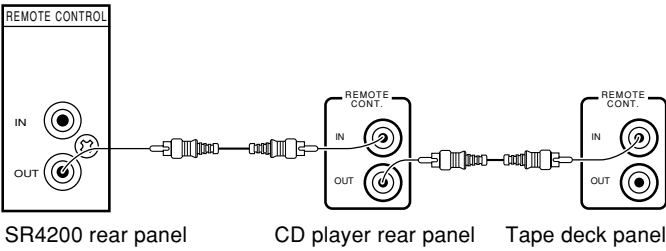

CONNECTION FOR A SUBWOOFER

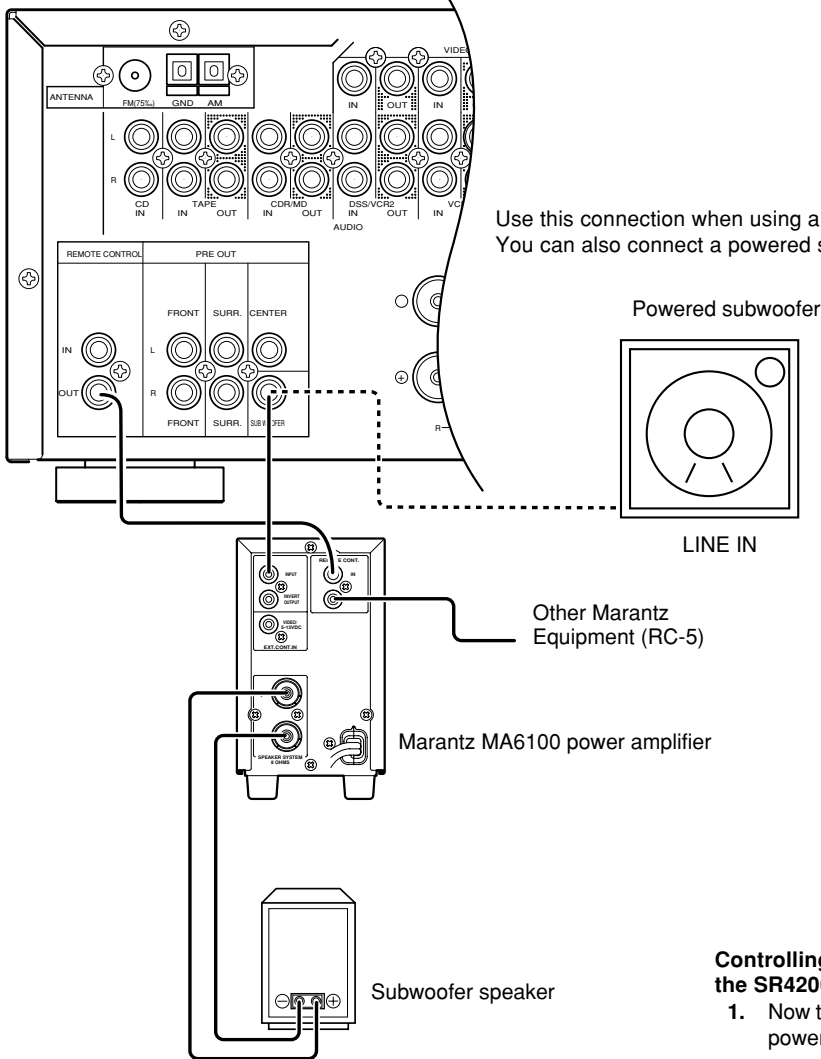

Controlling the power ON/OFF of a power amplifier connected to the SR4200 through Marantz remote control

1. Now the MA6100 can be turned ON / OFF in synchronism with the power ON / OFF of the SR4200.

Notes:

- Be sure to connect the remote control bus before the procedure above.

REMOTE CONTROL OPERATION

OPERATION

The provided remote control unit is a universal remote controller. The **POWER** button [2], numeric buttons [9] and control buttons [12] are used in common across different input source components.

The input source controlled with the remote control unit changes when one of the input selector buttons [3] is pressed.

• Example: To select the DVD as the input source and play the DVD player.

Press the **DVD** button [3] twice within 2 seconds.

The input selector of the SR4200 is switched to DVD and the remote control unit is set for control of the DVD player. Press the **PLAY** button on the remote controller .

FUNCTION AND OPERATION

1 Transmitting indicator

Lights up during a button is pressed and an infrared signal is sending.

2 Main POWER buttons

Press to switch the power of the SR4200 ON or OFF after pressing the **AMP** button [3].

3 Input selector buttons/ FUNCTION SELECTOR buttons (AUDIO/VIDEO INPUT)

Press one of these buttons once or twice to select a particular source component. For example, to set the receiver to the DVD input, press the **DVD** button twice within 2 seconds.

Note:

CDR/MD button is set CDR function at initial. To switch MD function, press and hold down **CDR/MD** button and press **2** button [9].

To return CDR function, press and hold down **CDR/MD** button and press **1** button [9].

4 MAIN VOLUME UP (▲) /DOWN (▼) buttons

Main volume control of the SR4200. The front, surround, center and subwoofer channel volumes controlled by these buttons simultaneously.

5 MUTE button

Muting button of the SR4200. Press this button decrease the sound temporarily . Press this button again to return to the previous sound.

6 MENU button

This button is used to enter the menu functions. Use the menu functions to setup SR4200.

7 Cursor buttons (◀, ▶, ▲, ▼, OK)

Use these button when operating the menu functions. See page 10.

8 MENU OFF button

This button is used to return original display from menu functions.

9 Numeric buttons 1 to 9 (A, B, C ... Z, -) / Surround mode buttons

Numeric buttons

These buttons are used to enter figures in the selection of a tuner preset station and station name preset or to set select a CD track number, etc. The functions of these buttons are dependent on the function button selected.

Surround mode buttons (when AMP mode is selected)

These buttons are used to select the surround mode.

Note:

The **6-STEREO** button is used to 5-stereo mode for SR4200.

The **CS5.1** and **6.1** buttons are unavailable for SR4200.

10 P.SCAN (preset scan) button (when TUNER mode is selected)

When this button is pressed, SR4200 is turned to tuner (last memory) and preset scan starts.

11 0 / A/D button

0 button

This button is used to enter the number "0"

A/D button (when AMP mode is selected)

This is used to switch between the analog and digital inputs.

12 CONTROL buttons

These buttons are used when operating the CD player, TAPE deck, etc. The function of these buttons are dependent on the function button selected.

For the controllable functions of each input function, please refer to following table.

	TV	VCR	DVD	DSS	TUNER	CD	TAPE	CDR	MD
◀ CHANNEL/SKIP	CH-	PREV	PREV	CH-	CH-	PREV	PREV	PREV	PREV
▶ CHANNEL/SKIP	CH+	NEXT	NEXT	CH+	CH+	NEXT	NEXT	NEXT	NEXT
◀ TUNE/SERCH	---	REWIND	REWIND	---	TUNING-	REWIND	REWIND	REWIND	REWIND
▶ TUNE/SERCH	---	FF	FF	---	TUNING+	FF	FF	FF	FF
●	---	REC	---	---	---	REC	REC	REC	REC
◀▶ MODE	---	---	---	---	MODE	---	DIRECTION	---	---
DSIP/RDS	CH DISPLAY	PAUSE	PAUSE	CH DISPLAY	RDS DISPLAY	PAUSE	PAUSE	PAUSE	PAUSE
▶ F.DIRECT	---	PLAY	PLAY	---	FREQ. DIRECT	PLAY	PLAY	PLAY	PLAY
+A/ANT	VIDEO	TV/VCR	DISC +	DSS/VCR	---	DISC +	DECK A	---	---
-B/VCR	VIDEO	TV/VCR	DISC +	DSS/VCR	---	DISC -	DECK B	---	---
■ PTY	---	STOP	STOP	---	RDS PTY	STOP	STOP	STOP	STOP

13 ATT (attenuater) button

When the input signal is too high and the voice distorts even by throttling the SR4200 VOLUME control and PEAK indicator will light up, turn on this function. "ATT" is indicated when this function is activated

The input level is reduced. Attenuater is invalid for use with the output signal of "REC OUT".

14 TREBLE buttons

These buttons are used to adjust the tone control of high frequency sound for left, center and right speaker.

15 BASS buttons

These buttons are used to adjust the tone control of low frequency sound for left, center right and subwoofer speaker.

16 MEMO button

Memory enable button for various preset functions.

17 CLEAR button

This button is used to cancel for certain memory or programming operations.

18 DIMMER button

When this button is pressed once, the display is dimmed.

When this button is pressed twice, the display is turned off and the "DISPLAY OFF" indicator lights up.

Press this button again to turn on the display again.

19 NIGHT button

Pressing this button prevents the Dolby Digital signal from playback at a loud voice. This function reduces the voice by 1/3 to 1/4 at maximum. Thus, it eliminates the occurrence of an abruptly loud voice at night. However, the function is valid only for the case when the Dolby Digital signal is entered into OPTICAL or COAXIAL and data to compress the voice exists in the signal to be played back.

20 S- (Source) DIRECT button

When this button is pressed, the tone control circuit is bypassed as well as Bass Management.

21 SETUP / T.TONE button

Test tone function is used for adjusting the balance between the volume levels of speaker channels. Press AMP button and press this button to generate pink noise from each channel. Press the button again to stop the pink noise generation.

22 OSD button

This button is not used for SR4200.

23 SLEEP (sleep timer) button

This button is used for setting the sleep timer. It can be operated the same way as the button in unit.

24 TV VOLUME UP (▲) /DOWN (▼) buttons

These buttons increase or decrease TV's volume.

PROGRAMMING THE REMOTE CONTROLLER

The remote controller RC5200SR must be programmed to use the codes for your appliances of different brands. This is done by keying in a 4-digit code or by scanning the codes until the correct one is found. We recommend to using the 4-digit code. This mode is faster and more reliable. The code scanning method should be used only if you cannot find the code for one of your appliances. The codes are listed at the end of this book.

Important:

Use the remote control buttons for programming, not the buttons of the receiver or other appliances.

PROGRAMMING WITH THE 4-DIGIT CODE

1. Press and hold down the function button **[3]** for the appliance which should be controlled and press **SETUP [21]** until the indicator **[1]** blinks twice.
2. Press the 4-digit code for appliance (codetable at the end of this book)
3. When the procedure is successful, the indicator will blink twice.

Notes:

If the indicator did not blink twice, then repeat steps 1 through 2 and try entering the same code again.

SCANNING THE CODE TABLE

1. Switch on the appliance which should be controlled.
2. Press and hold down the function button **[3]** for appliance which should be controlled and press **SETUP [21]** until the indicator **[1]** blinking twice.
3. Press the code **9 - 9 - 1**.
The indicator will blink twice.
4. Aim the remote control at the appliance and slowly alternate between pressing **POWER [2]** and the function button **[3]** for the appliance.
5. Stop when the appliance turns off.
6. Press **SETUP [21]** once to lock in the code.

CHECKING THE CODE

1. Press and hold down the function button **[3]** for appliance which should be controlled and press **SETUP [21]** until the indicator **[1]** blinking twice.
2. Press the code **9 - 9 - 0**.
The indicator will blink twice.
3. To view the code for first digit, press **1** once.
Wait 3 seconds, count the indicator blinks (e.g. 3 blinks = 3) and write down the number.
Note:
If a code digit is "0", the indicator will not blink.
4. Repeat step 3 three more times for remaining digits. Use **2** for the second digit, **3** for the third digit, and **4** for the fourth digit.

Once you have found and the codes for your various appliances, you may want to write them down here.

- TV _____
- VCR _____
- DSS _____
- DVD _____
- CD _____
- TAPE _____
- CDR _____
- MD _____

OPERATION OF REMOTE CONTROL UNIT

1. Remote control

The distance between the transmitter of the remote control unit and the IR SENSOR of the SR4200 should be less than about 5 meters. If the transmitter is pointed to a direction other than the IR SENSOR or if there is an obstacle between them, remote control may not be possible.

Remote-controllable range

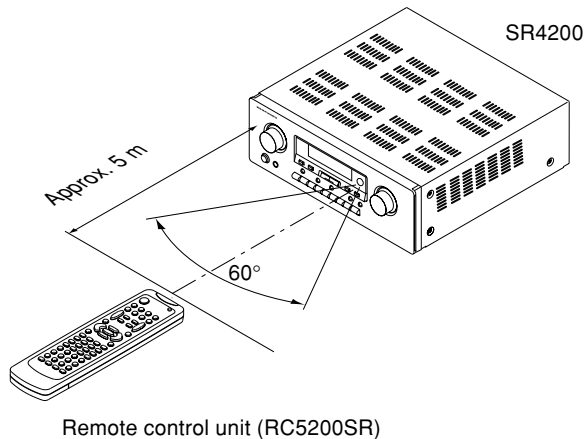

2. Loading batteries

The life of the batteries used with the remote control unit is about 4 months with normal use. Also be sure to replace batteries earlier when you notice that they are getting weak.

(1) Remove the back cover.

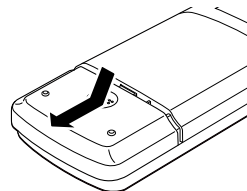

(2) Insert the new batteries (AAA type) with correct (+) and (-) polarity.

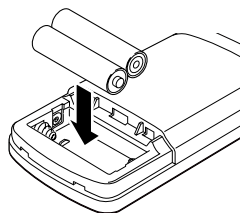

(3) Close until it clicks.

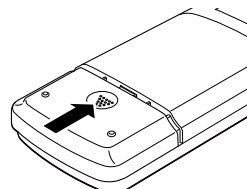

SET-UP

After all components are connected, initial setup must be performed.

MENU FUNCTION

The SR4200 incorporates a menu function, which makes various operations possible by using the cursor (◀, ▶, ▲, ▼) and OK buttons on the remote controller.

MENU STRUCTURE

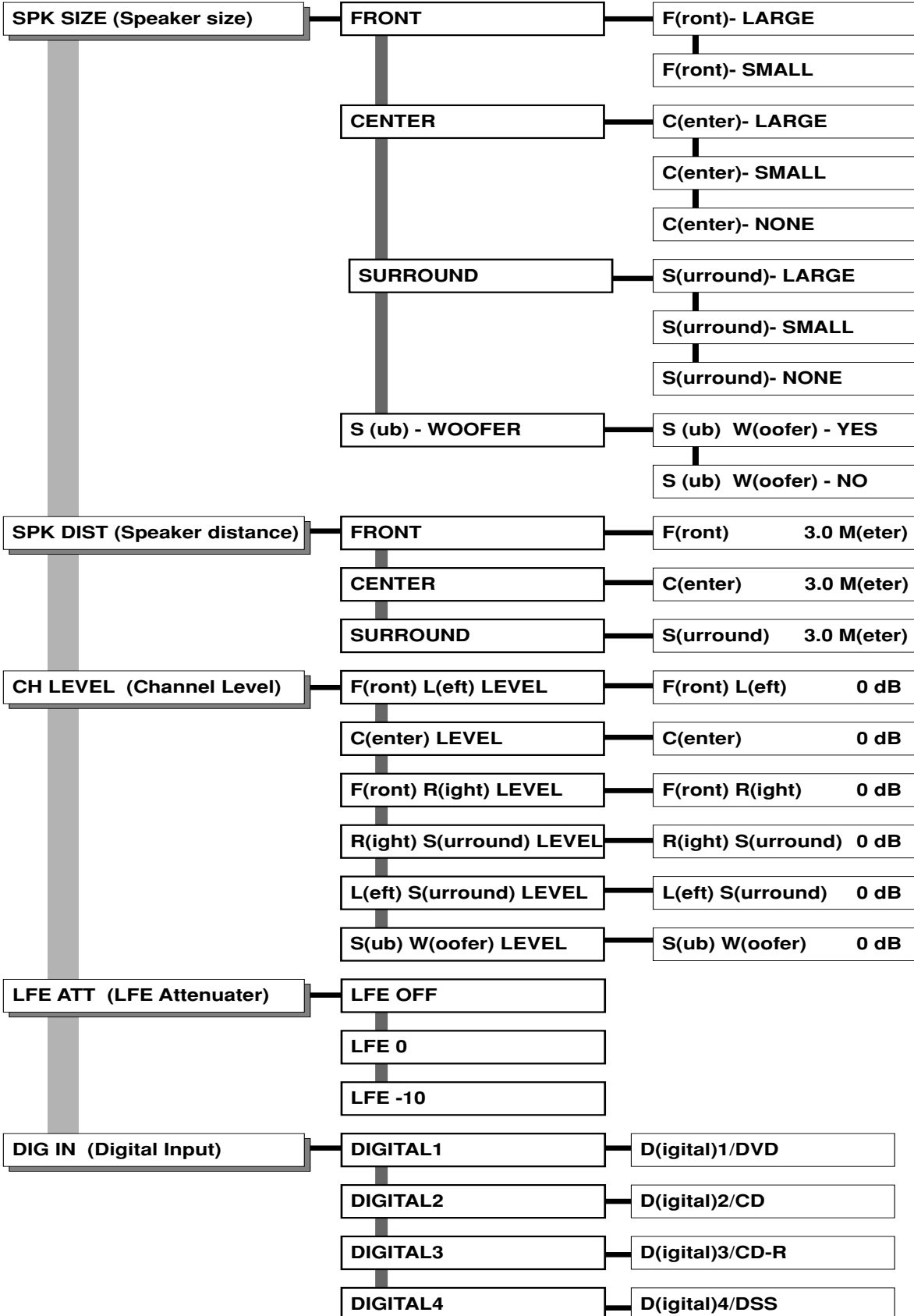

SYSTEM SETUP

1. Press the **AMP** button [3].
2. Press **MENU** button [6] display the menu.



Choose a desired item in the contents with ▲ or ▼ button, and press the **OK** or ► button to select. Display will change to menu for each item.

Note:

If no operating continues for 1 minute or more, the setup menu is cancelled and the display will return to original.

SPEAKERS SETUP

The home theater system you already have installed should function provided that there are left, center and right front speakers, left and right rear/surround speakers and a subwoofer. For best results we recommend that all front speakers be of the same type, with identical or similar driver units. This will deliver smooth pans across the front sound stage as the action moves from side to side. Your center channel speaker is very important as over 80 % of the dialog from a typical motion picture emanates from the center channel. It should possess similar sonic characteristics to the main speakers. Rear channel speakers need not be identical to the front channel speakers, but they should be of high quality. One of the benefits of both Dolby Digital (AC-3) and DTS is that surround channels are discrete full range, while they were frequency limited in earlier "Pro Logic" type systems. Bass effects are an important part of home theater. For optimal enjoyment a subwoofer should be used as it is optimized for low frequency reproduction. If you have full range front speakers, however, they may be used in place of a subwoofer with proper setting of the switches in the menu system.

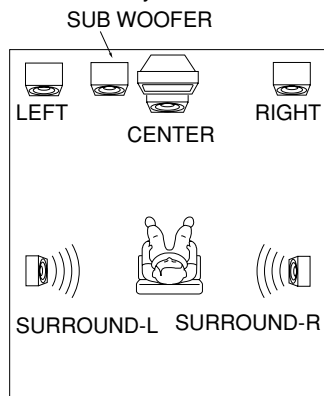

If possible, mount the surround speakers on the walls to the sides of the viewing area, 2-3 feet above seated viewers, firing straight across at each other.

SPK SIZE (Speake size)

This menu enters the information about which type of speakers will be used for each channel. In turn, these settings will determine which speakers receive low frequency information. For the purpose of establishing proper bass reproduction, use the LARGE settings if the speaker being used at any position is a traditional full-range loudspeaker that is capable of reproducing sound below 100 Hz and you are not using a subwoofer. Use the SMALL setting for smaller, frequency-limited speakers that are not able to reproduce sounds below 100Hz and you are using a subwoofer. Low frequencies will be diverted from the speaker to the subwoofer. Note that when "small" speakers are used it is advisable to install a separate subwoofer, especially if you wish to appreciate the full impact of a good home theater soundtrack. If the Surround speakers or Center speaker will not be used, set NONE for each speaker. The NONE setting will send the audio for the surround channels or Center channel to the front left/right speakers.

FRONT : Select the type of front speakers with ▲ or ▼ button.



CENTER : Select the type of center speaker with ▲ or ▼ button.



SURROUND: Select the type of surround speakers with ▲ or ▼ button.



S-WOOFER: Select the subwoofer speaker YES or NO with ▲ or ▼ button.



Notes:

This speaker size setup is not effective when the SOURCE-DIRECT is selected. When the front speakers are set to SMALL, the setting for subwoofer is automatically set to YES. This subwoofer setting will not be shown on the display.

SPK DIST (Speaker distance)

Use this parameter to specify the distance of the speaker's position from the listener. The delay time is automatically set according to these distances.

UNITS: Select speaker with ▲ or ▼ button, and input each speaker's distance with ▲ or ▼ button. When the input for each speaker's distance has been finished, and press the **OK** or ► button.

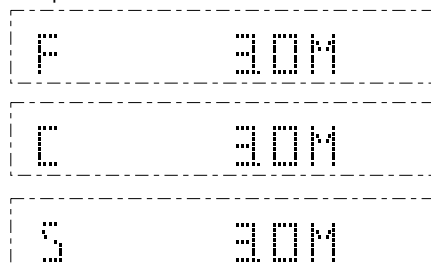

Notes :

Placement beyond that distance is beyond the range of the automatic time delay feature. The delay feature does not function in the SOURCE-DIRECT and decoding of 96 kHz sources.

CH LEVEL (Channel level)

Desired channels can be selected by pressing ▲ or ▼ button. Each channel level will be adjusted by pressing ▲ or ▼ button. Only the usable channels which are determined depending on the SURROUND mode, and SPEAKER SETTING are displayed.

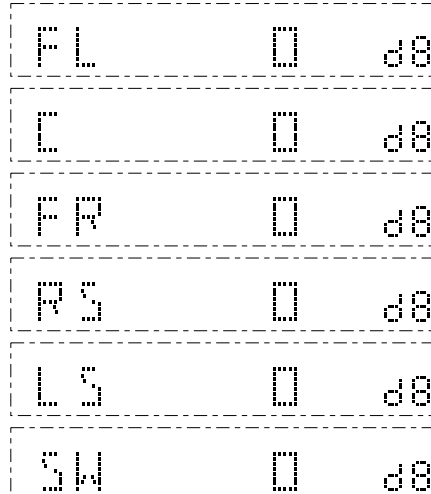

LFE ATT (LFE attenuater)

Select the output level of the LFE signal included in the Dolby Digital signal or the DTS signal. Select 0dB, -10 dB or OFF with ▲ or ▼ button.

The level is ordinarily set to 0 dB. When use DTS Music source, LFE level is set to -10 dB.

**DIG IN (Digital input)**

Four digital inputs can be assigned for the desired source. Use this menu to determine which source is connected to which input.

Example;

When the digital output of a DVD player is connected to Digital 4 (input jack) of the SR4200;

1. Select "DIG IN" with cursor buttons ▲ or ▼ and press the OK or ► button.



2. Select "DIGITAL4" with cursor buttons ▲ or ▼ and press the OK or ► button.



3. Select "D4/DVD" with cursor buttons ▲ or ▼ and press the OK or ► button.



4. If you desire to continue the next setup, press the OK or ► button on NEXT-SETUP.
If you desire to exit from menu system, press the MENU OFF button on EXIT.

Notes:

The TUNER is assigned to the analog input, and are prevented from selecting any digital input.

While the DTS-LD or DTS-CD is playing, this setup is not available, this is to avoid noise being generated from the analog input. Stop the LD or CD playback to setup.

The SR4200 does not switch from digital input to analog input or vice versa automatically.

In the event that both digital and analog inputs are connected to SR4200, if you desire to switch to an analog input temporarily, you can switch by pressing the A/D button ⑥.

TEST MODE

When you press the T.TONE ⑫, the test tone will be cycled through in a circular pattern which is FL (front left) → C (center) → FR (front right) → RS (right surround) → LS (left surround) → SW (subwoofer) → FL → ... 3 seconds for each channel.

BASIC OPERATION

LISTENING TO THE TUNER

MANUAL TUNING

1. To select the tuner as the source, press the **TUNER** button ⑤ on the front panel or press the **TUNER** button ③ on the remote.
2. Press the **TUNER** button ⑤ on the front panel or press the **TUNER** button ③ on the remote to select the desired frequency band if required.
3. Press the **F/P** button ⑭ on the front panel to display the frequency.
4. Press the **TUNING/PRESET ▲** or **▼** button ⑬ on the front panel or press the **◀◀** or **▶▶** button ⑫ on the remote.
5. If FM is selected, press the **MODE** button ⑮ on the front panel or press the **MODE** button ⑫ on the remote control to select the desired audio mode.

(FM) MODE BUTTON OPERATION

When "M" indicator is on in the display, FM stations that broadcast in stereo will be received in stereo and the "STEREO" indicator lights. When "M" indicator is off, all the FM stations will be received in mono regardless of whether or not they are broadcasting in stereo.

AUTO TUNING (USING THE SR4200)

1. Press the **F/P** button ⑭ on the front panel to display the frequency.
2. Press the **TUNING/PRESET ▲** or **▼** button ⑬ on the front panel for more than 1 second to start the Auto tuning function.

AUTO TUNING (USING THE REMOTE CONTROL UNIT)

Press **◀◀** or **▶▶** button ⑫ for more than 1 second to start the Auto tuning function.

PRESET TUNING

With this unit you can preset up to 50 FM/AM (MW/LW) stations in any order. For each station, you can memorize the frequency and reception mode if desired.

1-a. Manual Presetting (Using the SR4200)

1. Refer to the "MANUAL TUNING" or "AUTO TUNING" section above to tune in a desired station.
2. Press the **MEMORY** button ⑫. "MEMO" indicator starts blinking on the display.
While "MEMO" is still blinking (approx. 5 seconds), select the preset number by pressing the **TUNING/PRESET ▲** or **▼** button ⑬ then press the **MEMORY** button ⑫ again.
3. When a number has been properly input, "MEMO" indicator stops blinking and goes out.
The station is now stored in the specified preset memory location.

1-b. Manual Presetting (Using the remote control unit)

1. Tune in a desired station.
2. Press the **MEMO** button ⑫.
3. Enter the desired preset number with ten keypad ⑨.
* When entering a single digit number (2, for example), either input "02" or just input "2" and wait for a few seconds.
* If a number other than 1-50 is entered by mistake, that number flashes in the display to indicate that it is invalid and the display returns to the original frequency display.

2. Auto Presetting

This function automatically scans the AM (MW/LW) and FM band and enters all stations with sufficient signal strength into the memory.

1. Select the FM band with the **TUNER** button ⑤.
2. Tune in the lowest receivable frequency.
3. Press and hold down the **MEMORY** button ⑫ and **TUNING/PRESET ▲** button ⑬ simultaneously, auto presetting will start.
4. Each time the tuner finds a station, the scanning will pause and memory.
5. Operation stops automatically when all 50 preset memory positions are filled or when auto scanning attains the highest end of all bands.
To stop the auto preset function at anytime, press the **CLEAR** button ⑪.

3. Recalling a Preset Station

1. Press the **F/P** button ⑭ to change the display to preset.
2. Select the desired preset station by pressing **TUNING/PRESET ▲** or **▼** button ⑬ on the front panel or press **CHANNEL** button ⑫ on the remote.

Note:

To directly access the preset stations using the numeric keypad, select the desired preset station by entering one or two digits using the numeric keypad ⑨.
To return to the Manual Tuning mode, press the **F/P** button ⑭.

4. Preset Scan Tuning (Using the remote control unit)

1. Press the **P.SCAN** button ⑩ on the remote control. (The preset station with the smallest preset number is recalled first. If no stations have been preset, CH "00" blinks in the display and the unit returns to the previous mode.)
2. Preset stations are recalled in sequence (CH-1 → CH-2, etc.) for 5 seconds each. Preset numbers that do not contain stations are skipped.
3. You can fast forward the preset stations by pressing the **CHANNEL ▶▶** button ⑫ continuously.
When the desired preset station is received, cancel the preset scan operation by pressing the **CHANNEL ◀◀** button ⑫ or the **CLEAR** button ⑪.



5. Clearing Preset Stations

You can remove preset stations from memory using the following procedure.





1. Recall the preset number to be cleared with the method described in "Recalling" a preset station .
2. Press the **MEMORY** button ⑫ on the front panel or **MEMO** button ⑫ on the remote unit, "MEMO" blinks in the display for 5 seconds. While "MEMO" is still blinking, press the **CLEAR** button ⑪ on the front panel or **CLEAR** button ⑪ on the remote unit.
"CLEAR" appears on the display to indicate that the specified preset number has been cleared.

STATION NAME PRESET

The station name preset function allows the name of each preset channel to be entered using alphanumeric characters. The Station Name button is valid only in the tuner mode. Before station name preset operation, store stations with the preset memory operation.

1. Press the **MEMORY** button  on the front panel or **MEMO** button  on the remote for more than 3 seconds.
2. The left most column of the station name indicator flashes, indicating the character entry ready status.



[Operation (Using the SR4200)]

3. When you press the **TUNING/PRESET**  or  buttons  is turned, alphabetic and numeric characters will be displayed in the following order:
A → B → C ... Z → 1 → 2 → 3... 0 → - → + → / → (Blank) → A
 UP →
 ← DOWN
4. After selecting the first character to be entered, press the **MEMORY** button . The entry in this column is fixed and the next column starts to flash. Fill the next column and press the **MEMORY** button  for more than 3 seconds to confirm the entry.

[Operation (Using the remote control unit)]

First, press the **TUNER** button  on the remote control unit.

(This operation is not necessary if the remote control unit has already been operated in the TUNER mode.)

3. Enter the character using the ten keypad . For example, to enter "A":
 1) Press the "1" button. "A" appears on the display column.
 2) Every time the 1 button is pressed, the displayed character changes in the order: **A → B → C → 1 → A...**
 Pressing buttons other than the "1" button cause different characters to be displayed in a similar way, so that other alphanumeric characters can be entered. To enter a blank or space, press the "9" button.
4. When the desired character is displayed, press the **MEMO** button  to confirm the entry in this column and move to the next column. After having filled all of the 8 columns, press the **MEMO** button  for more than 3 seconds to confirm the entry.

FREQUENCY DIRECT CALL (Using the remote control unit)

1. Press the **F.DIRECT** button  in the TUNER MODE on the remote controller.
2. Front display will show "F-DIR IN".
3. Input your desired frequency with ten key pad button on the remote.

RDS OPERATION

Now in use in many countries, RDS (Radio Data System) is a description of the station's programming hidden space in the FM signal.

Your new receiver is equipped with RDS to assist in the selection of FM stations using station and network names, rather than broadcast frequencies. Additional RDS functions include the ability to search for programme types.

RADIO TEXT

Some RDS stations broadcast RADIO TEXT, which is additional information on the station and programme being broadcast.

RADIO TEXT information appears as 'running' text in the display. RADIO TEXT is transmitted character-by-character by the radio station. As a result of that it may take some time until the entire text has been completely received.

RDS DISPLAY

When a receiver is tuned to an FM station that is transmitting RDS data, the Front Panel Information Display will automatically show the station name or RDS TEXT in place of the typical display of the station's broadcast frequency.

To change the display, press the **RDS** button  on the remote controller.

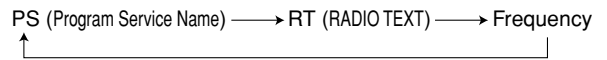





PROGRAMME TYPE (PTY) DISPLAY

The RDS system categorizes programmes according to their genre into different programme type (PTY) groups. To display the programme type information of the current station, press the **PTY** button  in the TUNER MODE on the remote controller.

PTY AUTO SEARCH

Your receiver is equipped to automatically search for stations transmitting any of 29 different programme types. To search for a PTY, follow these procedures:

1. Press the **PTY** button  in the TUNER MODE on the remote controller. The current station's PTY will be displayed, or the currently selected PTY group will be displayed in blinking if no station or RDS data is present.
2. To change to a new PTY type, press the **CHANNEL** button  until the desired PTY is shown in the display.
3. Once the desired PTY group or type has been selected, press the **PTY** button  while the display blink (approx. 5 seconds). The PTY Auto search will start, and the tuner will pause at each station broadcasting RDS PTY information corresponding to the selected choice.
4. To advance to the next RDS station with the desired PTY, press the **PTY** button  again within 5 seconds.

NUMBER	DISPLAY	PROGRAMME TYPE
1	POP	Pop Music
2	ROCK	Rock Music
3	MOR	M. O. R. Music
4	LIGHT	Light classical
5	CLASSIC	Serious classical
6	NEWS	News
7	AFFAIR	Current Affairs
8	INFO	Information
9	SPORT	Sport
10	EDUCATE	Education
11	DRAMA	Drama
12	CULTURE	Culture
13	SCIENCE	Science
14	OTHERS	Varied
15	OTHER	Other Music
16	WEATHER	Weather
17	FINANCE	Finance
18	CHILDREN	Children's programmes
19	SOCIAL	Social Affairs
20	RELIGION	Religion
21	PHONE IN	Phone In
22	TRAVEL	Travel
23	HOBBIES	Hobbies
24	JAZZ	Jazz Music
25	COUNTRY	Country Music
26	NATION	National Music
27	OLDIES	Oldies Music
28	FOLK	Folk Music
29	DOCUMENT	Documentary

PLAYBACK OPERATION

NORMAL PLAYBACK

1. Press the **POWER** button ① / 2.
2. Press the **FUNCTION SELECTOR** button ⑤ on the front panel or press the **FUNCTION** button ③ on the remote unit to select an input source.

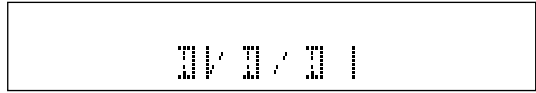

3. Turn the **SURROUND MODE SELECTOR** knob ③ on the front panel or Surround mode buttons ⑨ in the AMP MODE on the remote unit to select the desired surround mode.



4. Adjust the volume level using the **VOLUME** knob ④ on the front panel or press the **MAIN VOL.** button ④ on the remote. If necessary, adjust the tone, press the **TRB▲**, **TRB▼** ⑭ and **BAS▲**, **BAS▼** ⑮ on the remote unit.

Note:

In case of remote control operation, press one of the function buttons twice within 2 seconds to select the function.

SETTING THE SLEEP TIMER

Set the sleep timer while the power is turned on.

1. Turn the power ON and press the **SLEEP** button ⑧ / 23.
2. Press the **SLEEP** button ⑧ / 23 the number of times to set the desired sleep time in minutes.

Each press of the **SLEEP** button ⑧ / 23 or changes the display in the following order:

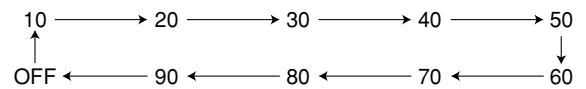

The unit will shut off in the number of minutes indicated.

* While the sleep timer is activated, the remaining time can be displayed for approximately 2 seconds by pressing the **SLEEP** button ⑧ / 23.

* To cancel the sleep timer, press the **SLEEP** button ⑧ / 23 and then press the **CLEAR** button ① / 17.

SURROUND MODES

The SR4200 incorporates digital signal processors (DSP) which can reproduce various surround effects you experience in concert halls and movie theaters, etc. These Surround Modes, are provided to reproduce a variety of surround sound effects, according to the content of the source to be played.

Surround mode	FEATURES
1. AUTO	When this mode is selected, the receiver determines whether the digital input signal is Dolby Digital, PCM-audio or DTS. Note: When a Dolby Digital or DTS signal is input, the number of channels for which the corresponding signal is encoded will be played. Inputting a Dolby Digital two channel signal with Dolby surround status automatically subjects that signal to ProLogicII processing before play. 96 kHz source material can be playback in this mode and 96k will be shown in the display.
2. STEREO	This mode bypasses all surround processing. Stereo program sources the left and right channels play normaly when PCM-audio or analog stereo is input. With Dolby Digital and DTS sources, the 5.1 multi-channels are converted to two channel stereo. 96 kHz source material can be playback in this mode and 96k will be shown in the display.
3. □□ MOVIE MUSIC PRO LOGIC	This mode is used with source materials encoded in Dolby Digital and Dolby Surround. Dolby Pro Logic II brings the excitement of surround sound to any stereo mix, while making existing Dolby Surround mixes sound more like discrete 5.1 channels Surround sound. Dolby Pro Logic II has below 3 modes. This mode provides 5.1 channel surround sound from Dolby Surround encoded stereo movie sound tracks. This mode provides 5.1 channel surround sound from conventional stereo sources, analog or digital, such as CD, tape, FM, TV, stereo VCR, etc. This mode emulated original Dolby Pro Logic decoding (3/1 surround) suit for Dolby Surround encoded stereo movie soundtracks. Note: PCM-audio signals can be subjected to Pro Logic processing when the sampling frequency is 32 kHz, 44.1 kHz or 48 kHz. When a signal in another format is input, output will be muted.
4. DTS	This mode is for DTS encoded source materials such as LASER DISC, CD, and DVD. The DTS mode cannot be used when an Analog input has been selected. When the signal in another digital format is input, output will be muted.
5. MOVIE HALL MATRIX GAME	These modes provide surround effect processing from each input source material. They will produce theater, concert hall and stadium like atmospheres. Select as your taste desires. Note: PCM-audio (32 kHz, 44.1 kHz or 48 kHz) and analog source material can playback in this mode.
6. VIRTUAL	This mode create the virtual surround sound with the front right and left speakers. Note: PCM-audio (32 kHz, 44.1 kHz or 48 kHz) and analog source material can playback in this mode.
7. 5-STEREO	This mode is used to create a wider, deeper and more natural soundstage from two channel source material. This is done by feeding the left channel signal to both left front and left surround speaker and the right channel signal to both right front and right surround speaker. Additionally, the center channel reproduces a mix of the right and left channel. Note: The 96 kHz sampling frequency mutes output.

Caution for DTS signal:

This signal can be played when the connected DVD-player, laser-disc player or CD-player is capable of DTS-digital output. For details, refer to the player's operation manual.

Depending on the player used, DTS play may produce noise. If that happens, set the Surround mode to DTS.

Playing a DTS-CD or DTS laser disc causes the player's analog output terminal to output noise. Before playing DTS sources, be sure to connect the player's digital output to the SR4200's digital input. Be careful when connecting the output of these players to analog audio input.

Note that the SR4200 has the following restrictive functions built in to reduce noise emission as much as possible.

If DTS is selected while in the Surround mode, digital input cannot be switched to analog input. When the analog input function has been selected, Surround mode cannot be switched to DTS.

While signals from DTS-laser disc or CD are playing in another Surround mode, you cannot switch to digital input or from digital input to analog input.

Caution for 96kHz PCM-audio signal:

This signal can be played when a DVD-player or DAT-player connected to the SR4200 is capable of 96 kHz PCM output. For details, refer to the player's operation manual.

The signal can be played when STEREO or AUTO has been selected for the Surround mode.

Some DVD formatted discs featured copy protect. When use such disc, 96 kHz PCM signal is not output from the DVD player. For details, refer to the player's operation manual.

The relation between the selected surround mode and the input signal

The surround mode is selected with the surround mode buttons of the SR4200 or the remote control unit. However, the sound from the speakers depend upon the relationship between the selected surround mode and the input signal. They are as follows;

SURROUND MODE	INPUT SIGNAL	OUTPUT				FLUORESCENT INDICATOR	
		L/R	LS/RS	C	SW	FORMAT STATUS & SURROUND MODE	TEMPORARY DISPLAY STATUS
AUTO	DOLBY DIGITAL(5.1CH)	○	○	○	○	□□ DIGITAL , AUTO	>AUTO>
	DOLBY DIGITAL(2CH)	○	—	—	○	□□ DIGITAL , AUTO	>AUTO>
	DOLBY DIGITAL(2CH:Lt/Rt)	○	○	○	○	□□ DIGITAL, MOVIE, AUTO	>AUTO>
	96KHZ PCM	○	—	—	—	PCM, STEREO , AUTO	>AUTO>
	PCM(AUDIO)	○	—	—	○	PCM, STEREO , AUTO	>AUTO>
	ANALOG	○	—	—	○	STEREO , AUTO	>AUTO>
	DTS(5.1CH)	○	○	○	○	dts , AUTO	>AUTO>
STEREO	DOLBY DIGITAL(5.1CH)	○	—	—	○	□□ DIGITAL,STEREO	>STEREO>
	DOLBY DIGITAL(2CH)	○	—	—	○	□□ DIGITAL,STEREO	>STEREO>
	DOLBY DIGITAL(2CH:Lt/Rt)	○	—	—	○	□□ DIGITAL,STEREO	>STEREO>
	96KHZ PCM	○	—	—	—	PCM, STEREO	>STEREO>
	PCM(AUDIO)	○	—	—	○	PCM, STEREO	>STEREO>
	ANALOG	○	—	—	○	STEREO	>STEREO>
	DTS(5.1CH)	○	—	—	○	dts , STEREO	>STEREO>
□□ MOVIE	DOLBY DIGITAL(5.1CH)	○	○	○	○	□□ DIGITAL	>DOLBY D>
	DOLBY DIGITAL(2CH)	○	○	○	○	□□ DIGITAL, MOVIE	>DOLBY PLII>
	DOLBY DIGITAL(2CH:Lt/Rt)	○	○	○	○	□□ DIGITAL, MOVIE	>DOLBY PLII>
	96KHZ PCM	—	—	—	—	(PCM), □□, MOVIE	>DOLBY PLII>
	PCM(AUDIO)	○	○	○	○	PCM, □□, MOVIE	>DOLBY PLII>
	ANALOG	○	○	○	○	□□, MOVIE	>DOLBY PLII>
	DTS(5.1CH)	—	—	—	—	(dts), □□, MOVIE	>DOLBY PLII>
□□ MUSIC	DOLBY DIGITAL(5.1CH)	○	○	○	○	□□ DIGITAL	>DOLBY D>
	DOLBY DIGITAL(2CH)	○	○	○	○	□□ DIGITAL, MUSIC	>DOLBY PLII>
	DOLBY DIGITAL(2CH:Lt/Rt)	○	○	○	○	□□ DIGITAL, MUSIC	>DOLBY PLII>
	96KHZ PCM	—	—	—	—	(PCM), □□, MUSIC	>DOLBY PLII>
	PCM(AUDIO)	○	○	○	○	PCM, □□, MUSIC	>DOLBY PLII>
	ANALOG	○	○	○	○	□□, MUSIC	>DOLBY PLII>
	DTS(5.1CH)	—	—	—	—	(dts), □□, MUSIC	>DOLBY PLII>
□□ PRO LOGIC	DOLBY DIGITAL(5.1CH)	○	○	○	○	□□ DIGITAL	>DOLBY D>
	DOLBY DIGITAL(2CH)	○	○	○	○	□□ DIGITAL, □□ PRO LOGIC	>DOLBY PL>
	DOLBY DIGITAL(2CH:Lt/Rt)	○	○	○	○	□□ DIGITAL, □□ PRO LOGIC	>DOLBY PL>
	96KHZ PCM	—	—	—	—	(PCM), □□ PRO LOGIC	>DOLBY PL>
	PCM(AUDIO)	○	○	○	○	PCM, □□ PRO LOGIC	>DOLBY PL>
	ANALOG	○	○	○	○	□□ PRO LOGIC	>DOLBY PL>
	DTS(5.1CH)	—	—	—	—	(dts), □□ PRO LOGIC	>DOLBY PL>
DTS	DOLBY DIGITAL(5.1CH)	—	—	—	—	(□□), dts	>DTS>
	DOLBY DIGITAL(2CH)	—	—	—	—	(□□), dts	>DTS>
	DOLBY DIGITAL(2CH:Lt/Rt)	—	—	—	—	(□□), dts	>DTS>
	96KHZ PCM	—	—	—	—	(PCM), dts	>DTS>
	PCM(AUDIO)	—	—	—	—	(PCM), dts	>DTS>
	DTS(5.1CH)	○	○	○	○	dts	>DTS>
	MOVIE HALL MATRIX GAME	DOLBY DIGITAL(5.1CH)	—	—	—	—	(□□), DSP, MOVIE/ HALL/ MATRIX/ GAME
DOLBY DIGITAL(2CH)		—	—	—	—	(□□), DSP, MOVIE/ HALL/ MATRIX/ GAME	>MOVIE/ HALL/ MATRIX/ GAME>
DOLBY DIGITAL(2CH:Lt/Rt)		—	—	—	—	(□□), DSP, MOVIE/ HALL/ MATRIX/ GAME	>MOVIE/ HALL/ MATRIX/ GAME>
96KHZ PCM		—	—	—	—	(PCM), DSP, MOVIE/ HALL/ MATRIX/ GAME	>MOVIE/ HALL/ MATRIX/ GAME>
PCM(AUDIO)		○	○	○	○	PCM, DSP, MOVIE/ HALL/ MATRIX/ GAME	>MOVIE/ HALL/ MATRIX/ GAME>
ANALOG		○	○	○	○	DSP, MOVIE/ HALL/ MATRIX/ GAME	>MOVIE/ HALL/ MATRIX/ GAME>
DTS(5.1CH)		—	—	—	—	(dts),DSP, MOVIE/ HALL/ MATRIX/ GAME	>MOVIE/ HALL/ MATRIX/ GAME>
VIRTUAL	DOLBY DIGITAL(5.1CH)	—	—	—	—	(□□), DSP, VIRTUAL	>VIRTUAL>
	DOLBY DIGITAL(2CH)	—	—	—	—	(□□), DSP, VIRTUAL	>VIRTUAL>
	DOLBY DIGITAL(2CH:Lt/Rt)	—	—	—	—	(□□), DSP, VIRTUAL	>VIRTUAL>
	96KHZ PCM	—	—	—	—	(PCM), DSP, VIRTUAL	>VIRTUAL>
	PCM(AUDIO)	○	—	—	○	PCM, DSP, VIRTUAL	>VIRTUAL>
	ANALOG	○	—	—	○	DSP, VIRTUAL	>VIRTUAL>
	DTS(5.1CH)	—	—	—	—	(dts),DSP, VIRTUAL	>VIRTUAL>
5-STEREO	DOLBY DIGITAL(5.1CH)	○	○	○	○	□□	>5-STEREO>
	DOLBY DIGITAL(2CH)	○	○	○	○	□□	>5-STEREO>
	DOLBY DIGITAL(2CH:Lt/Rt)	○	○	○	○	□□	>5-STEREO>
	96KHZ PCM	—	—	—	—	(PCM)	>5-STEREO>
	PCM(AUDIO)	○	○	○	○	PCM	>5-STEREO>
	ANALOG	○	○	○	○		>5-STEREO>
	DTS(5.1CH)	○	○	○	○	dts	>5-STEREO>

Note:

- Dolby Digital (2 ch: Lt/Rt): signal with Dolby Surround flag Speakers are full set.
- When □□, dts or PCM is blinking, the selected surround mode is unavailable for input signal. Select the other appropriate surround mode to playback.
- No sound outputs from the surround speaker, center speaker and subwoofer if the DVD disc has no surround data.

L/R : Front speaker () : The indicator blinks
 LS/RS : Surround speaker
 C : Center speaker
 SW : Sub woofer speaker

TROUBLE SHOOTING

If the unit does not operate properly, check items shown in the following table. If your trouble cannot be recovered with the remedy actions listed in the following table, malfunction of the internal circuitry is suspected; immediately unplug the power cable and contact your dealer, nearest Marantz distributor or the Marantz Service Center in your country.

In case of trouble, check the following before calling for service:

1. Are the connections made properly ?
2. Are you operating the unit properly following user's guide ?
3. Are the power amplifiers and speaker working properly ?

SYMPTOM	CAUSE	REMEDY
SR4200 cannot be turned up.	The power plug is not connected.	Connect the power plug to the outlet.
No sound and picture are output even when power is on.	Mute is on. The input cable is not connected correctly. The master volume control is turned all the way down. The function selector position is wrong.	Cancel mute using the remote control unit. See the connection diagram and connect the cables correctly. Adjust the master volume. Select correct position.
Speaker does not outputting any sound.	The headphones are connected to the headphone jack.	Disconnect the headphones. (Speakers will not output sound when headphones are connected.)
Sound and pictures from other than equipment selected with the function selector.	Input cable connected incorrectly.	Connect the cable correctly by referring to the connection diagram.
Sound from the wrong channel is output from the speaker.	Speaker cable connected incorrectly.	Connect the cable correctly by referring to the connection diagram.
No sound is output from the center speaker.	The center speaker cable connection is incomplete. STEREO has been selected for Surround mode. Center = NONE has been selected in SETUP mode.	Connect the cable correctly. When STEREO is selected for Surround mode, no sound will be output from the center speaker. Set another Surround mode. Make the correct setting.
No sound is output from the surround speakers.	The surround speaker cable connection is incomplete. STEREO has been selected for Surround mode. Surround = NONE has been selected in SETUP mode.	Connect the cable correctly. When STEREO has been selected for Surround mode, no sound will be output from the surround speaker. Set another Surround mode. Make the correct setting.
No output to Sub Woofer Out.	Sub-woofer = NO has been selected in SETUP mode.	Select Sub-woofer = YES.
Surround mode cannot be changed.	The headphones are connected to the jack.	Disconnect the headphones. (When headphones are connected, Surround mode will be fixed to STEREO.)
Noise is produced during DTS-encoded CD or laser disc play.	Analog has been selected for input.	Be sure to perform digital connection, select digital input, then play.
DTS sources cannot be played.	Surround mode is set to DOLBY. The DVD or LD player is not DTS digital out capable.	Select other mode. Use a player which responds to DTS-digital out.
Player skips during play of a DTS source and produces noise.	Data error occurred during player skip.	Set Surround mode to DTS.
A 96kHz PCM signal cannot be played.	The disc player is not 96kHz PCM digital out capable. Surround mode is set to other than STEREO and AUTO.	Use a player that responds to 96kHz PCM digital out. Set Surround mode to STEREO or AUTO.
A normal PCM signal (CD or laser disc) cannot be played.	Surround mode is set to DTS.	Select other mode.
A Dolby Digital signal cannot be played.	Surround mode is set to DTS.	Select other mode.
A specific channel does not produce output.	Nothing recorded on source.	Check the encoded channel on the source side.
FM or AM reception fails.	Antenna connection is incomplete.	Correctly connect the indoor FM and AM antennas to FM and AM antenna outlets.
Noise is heard during AM reception.	Reception is affected by other electrical fields.	Try changing location where the AM indoor antenna is set up.
Noise is heard during FM reception.	The radio waves from the broadcasting station are weak.	Install an FM outdoor antenna.
Cannot get programmed station when the PRESET button is pressed.	Preset data has been erased.	Disconnecting power plug for long periods of time will erase preset data. If that happens, input the preset data again.
Nothing appears on the remote commander display.	Batteries are consumed.	Replace all the batteries with new ones.
Control with the remote control unit fails.	Batteries are consumed. Remote controller's function-key setting is wrong. The distance between this SR4200 and the remote commander is too far. Something is blocking SR4200 and the remote commander.	Replace all the batteries with new ones. Select different position from which equipment will be controlled. Move closer to this SR4200. Remove offending object.

GENERAL MALFUNCTION

If the equipment malfunctions, this may be because an electrostatic discharge or AC line interference has corrupted the information in the equipment memory circuits. Therefore:

- disconnect the plug from the AC line supply
- after waiting at least three minutes, reconnect the plug to the AC line supply
- re-attempt to operate the equipment

HOW TO RESET THE UNIT

Should the operation or display seem to be abnormal, reset the unit with the following procedure.

Press **POWER** button [2] to set SR4200 in standby mode, then press and hold the **F/P** [14] until SR4200 is turned on.

Remember that the procedure will reset the settings of the function selector, Surround mode, delay time, TUNER PRESET etc., to their initial settings.

Memory backup

- In case a power outage occurs or the power cord is accidentally unplugged, the SR4200 is equipped with a backup function to prevent memory data such as the preset memory from being erased.

The memory functions are backed up for up to about one week.

NOTE:

First of all keep SR4200 Standby or Powered-on more than 6 hours, to sufficient time for memory back up.

SETUP CODES

CD

Aiwa	0151, 0184
Burmester	0447
California Audio Labs	0056, 0330
Carver	0184, 0206, 0326, 0464
DKK	0027
Denon	0030
Emerson	0332
Fisher	0201, 0206
Garrard	0420, 0447
Genexxa	0059, 0332
Harman/Kardon	0184, 0200
Hitachi	0059
JVC	0099
Kenwood	0055, 0064, 0217
Krell	0184
LXI	0332
Linn	0184
Luxman	0062, 0120, 0293, 0354, 0355, 0457, 0459, 0510, 0516
MCS	0056
MTC	0447
Magnavox	0184, 0332
Marantz	0056, 0184, 0207, 1207, 0999,
Mission	0184
NAD	0046, 0326, 0343, 0747, 0748
NSM	0184
Nakamichi	0106, 0174, 0466, 0471, 0691
Nikko	0201
Onkyo	0128
Optimus	0027, 0059, 0064, 0172, 0206, 0332, 0447, 0464, 0495
Panasonic	0056, 0330
Parasound	0447
Philips	0184
Pioneer	0059, 0271, 0332, 0495
Polk Audio	0184
Proton	0184
QED	0184
Quasar	0056
RCA	0059, 0080, 0206, 0332, 0495, 0791
Realistic	0206, 0207, 0447
Rotel	0184, 0447
SAE	0184
Sansui	0184, 0332
Sanyo	0206
Scott	0332
Sears	0332
Sharp	0064, 0207
Sherwood	0207
Sonic Frontiers	0184
Sony	0027, 0212
Soundesign	0172
Tascam	0447
Teac	0201, 0207, 0420, 0447
Technics	0056, 0330
Toshiba	0046, 0326
Victor	0099
Wards	0080, 0184
Yamaha	0063, 0214
Yorx	0488

MD PLAYERS

Denon	1900
Kenwood	1708, 1853
Marantz	1207
Onkyo	1895
Optimus	1090
Pioneer	1090
Sharp	1888
Sherwood	1094
Sony	1517
Yamaha	1915

CDR

Marantz	0999
---------	------

TAPE

Aiwa	0056, 0224
Carver	0056
Denon	0103
Garrard	0335, 0336
Harman/Kardon	0056, 0209
JVC	0271, 0300
Kenwood	0097
Magnavox	0056
Marantz	0056
NAD	0171
Onkyo	0162, 0309
Optimus	0054, 0247
Panasonic	0256
Philips	0056
Pioneer	0054, 0126, 0247
Polk Audio	0056
RCA	0054, 0247
Samsung	0418, 0419
Sansui	0056
Sony	0197, 0270, 0318
Teac	0307, 0335, 0336, 0418, 0419
Technics	0256
Victor	0300
Wards	0054
Yamaha	0121, 0124

SAT (DSS)

AlphaStar	0799
Echostar	0802, 1032
Expressvu	0802
General Instrument	0388, 0654, 0896
HTS	0802
Hitachi	0846
Hughes Network Systems	0776
JVC	0802
Jerrold	0388, 0654
Magnavox	0749, 0751
Memorex	0751
Next Level	0896
Panasonic	0728
Philips	0749, 0751, 1103
Primestar	0388, 0654
RCA	0170, 0419, 0593, 0882
Radio Shack	0896
Sony	0666
Star Choice	0896
Toshiba	0776, 0817
Uniden	0749, 0751
Zenith	0883

TV

AOC	0046, 0057
Admiral	0120, 0490
Aiko	0119
Akai	0057
Alaron	0206
Ambassador	0204
America Action	0207
Anam	0207
Audiovox	0119, 0207, 0478, 0650
Baysonic	0207
Belcor	0046
Bell & Howell	0043, 0181
Bradford	0207
Brockwood	0046
Broksonic	0263, 0490
CXC	0207
Candle	0057, 0083
Carnivale	0057
Carver	0081
Celebrity	0027
Cineral	0119, 0478
Citizen	0057, 0083, 0087, 0119
Concerto	0083
Contec	0207
Craig	0207
Crosley	0081
Crown	0207
Curtis Mathes	0043, 0057, 0074, 0078, 0081, 0083, 0087, 0120, 0172, 0181, 0193, 0478, 1174, 1374
Daewoo	0046, 0119, 0478, 0650, 0651
Daytron	0046
Denon	0172
Dumont	0044, 0046
Dwin	0747, 0801
Electroband	0027
Emerson	0046, 0181, 0204, 0205, 0206, 0207, 0263, 0490, 0650, 0651
Envision	0057
Fisher	0181
Fujitsu	0206, 0710
Funai	0206, 0207
Futuretech	0207
GE	0074, 0078, 0120, 0205, 0478, 1174, 1374
Gibraltar	0044, 0046, 0057
GoldStar	0046, 0057, 0083, 0205
Gradiente	0080, 0083
Grunpy	0206, 0207
Hallmark	0205
Harley Davidson	0206
Harman/Kardon	0081
Harvard	0207
Hitachi	0043, 0083, 0172
Infinity	0081
Inteq	0044
JBL	0081
JCB	0027
JVC	0080
KEC	0207
KTV	0057, 0207
Kenwood	0046, 0057
LG	0083
LXI	0074, 0081, 0181, 0183, 0205
Logik	0043
Luxman	0083
MGA	0046, 0057, 0177, 0205
MTC	0046, 0057, 0083, 0087
Magnavox	0057, 0081, 0206, 1281
Majestic	0043
Marantz	0057, 0081, 1581
Matsushita	0277
Megatron	0172, 0205
Memorex	0043, 0083, 0177, 0181, 0205, 0206, 0277, 0490
Midland	0044, 0074, 0078
Mitsubishi	0046, 0120, 0177, 0205
Motorola	0120
Multitech	0207
NAD	0183, 0193, 0205
NEC	0046, 0057, 0083
NTC	0119
Nikko	0057, 0119, 0205
Onwa	0207
Optimus	0181, 0193, 0277
Optonica	0120, 0192
Orion	0206, 0263, 0490
Panasonic	0078, 0277
Penney	0046, 0057, 0074, 0078, 0083, 0087, 0183, 0205, 1374
Philco	0046, 0057, 0081, 0172, 0490
Philips	0081
Pilot	0046, 0057
Pioneer	0193, 0706
Portland	0046, 0119
Prism	0078
Proscan	0074
Proton	0205
Pulsar	0044, 0046
Quasar	0078, 0192, 0277
RCA	0046, 0074, 0078, 0117, 0120, 0706, 1074, 1174, 1274, 1374, 1474
Radio Shack	0046, 0057, 0074, 0083, 0181, 0192, 0205, 0207
Realistic	0046, 0057, 0083, 0181, 0192, 0205, 0207
Runco	0044, 0057, 0630
SSS	0046, 0207
Sampo	0057
Samsung	0046, 0057, 0083, 0087, 0205
Sansei	0478
Sansui	0490
Sanyo	0181
Scimitsu	0046
Scotch	0205
Scott	0046, 0205, 0206, 0207, 0263
Sears	0074, 0081, 0083, 0181, 0183, 0205, 0206
Semivox	0207
Semp	0183
Sharp	0120, 0192, 0715
Shogun	0046
Signature	0043
Sony	0027
Soundesign	0205, 0206, 0207
Starlite	0207
Supreme	0027
Sylvania	0057, 0081
TMK	0083, 0204, 0205
TNCi	0044
Tandy	0120
Technics	0078, 0277
Technol Ace	0206
Techwood	0078, 0083
Teknika	0043, 0046, 0081, 0083, 0087, 0119, 0177, 0206, 0207
Telefunken	0083
Toshiba	0087, 0181, 0183, 1283
Vector Research	0057
Victor	0080
Vidikron	0081
Vidtech	0046, 0205
Wards	0043, 0046, 0057, 0081, 0083, 0192, 0205, 0206
White Westinghouse	0490, 0650, 0651
Yamaha	0046, 0057
Zenith	0043, 0044, 0119, 0490, 0651

VCR

Admiral 0075, 0236
Adventura 0027
Aiko 0305
Aiwa 0027, 0064
America Action 0305
American High 0062
Asha 0267
Audiovox 0064
Beaumarck 0267
Bell & Howell 0131
Broksonic 0148, 0211, 0236, 0506
CCE 0099, 0305
Calix 0064
Canon 0062
Carver 0108
Cineral 0305
Citizen 0064, 0305
Colt 0099
Craig 0064, 0074, 0099, 0267
Curtis Mathes 0062, 0087, 0189
Cybernex 0267
Daewoo 0072, 0305
Denon 0069
Dynatech 0027
Electrohome 0064
Electroponic 0064
Emerex 0059
Emerson 0027, 0064, 0070, 0148, 0211, 0236, 0305, 0506
Fisher 0074, 0131
Fuji 0062
Funai 0027
GE 0062, 0075, 0087, 0267
Garrard 0027
Go Video 0459
GoldStar 0064
Gradiente 0027
HI-Q 0074
Harley Davidson 0027
Harman/Kardon 0108
Harwood 0099
Hitachi 0027, 0069
Hughes Network Systems 0069
JVC 0094
KEC 0064, 0305
KLH 0099
Kenwood 0094
Kodak 0062, 0064
LXI 0064
Lloyd's 0027
Logik 0099
MEI 0062
MGA 0070, 0267
MGN Technology 0267
MTC 0027, 0267
Magnasonic 0305
Magnavox 0027, 0062, 0066, 0108
Magnin 0267
Marantz 0062, 0108, 1408
Marta 0064
Matsushita 0062, 0189
Memorex 0027, 0062, 0064, 0066, 0074, 0075, 0131, 0189,
0236, 0267, 0506, 1064, 1189, 1289
Minolta 0069
Mitsubishi 0070, 0075, 0094
Motorola 0062, 0075
Multitech 0027, 0099
NAD 0085

NEC 0094, 0131
Nikko 0064
Noblex 0267
Olympus 0062
Optimus 0064, 0075, 0085, 0131, 0189, 0459, 1075, 1089,
1189, 1289
Orion 0211, 0236, 0506
Panasonic 0062, 0189, 0252, 0643, 1089, 1189, 1289
Penney 0062, 0064, 0069, 0267
Pentax 0069
Philco 0062, 0236, 0506
Philips 0062, 0108, 0645, 1108, 1208
Pilot 0064
Pioneer 0085, 0094
Polk Audio 0108
Profitronic 0267
Proscan 0087
Protec 0099
Pulsar 0066
Quasar 0062, 0189, 1189
RCA 0062, 0069, 0075, 0085, 0087, 0267
Radio Shack 0027, 1064
Radix 0064
Randex 0064
Realistic 0027, 0062, 0064, 0074, 0075, 0131
ReplayTV 0641, 0643
Runco 0066
STS 0069
Samsung 0072, 0267
Sanky 0066, 0075
Sansui 0027, 0094, 0236, 0506
Sanyo 0074, 0131, 0267
Scott 0070, 0072, 0148, 0211
Sears 0027, 0062, 0064, 0069, 0074, 0131
Semp 0072
Sharp 0075
Shintom 0099
Shogun 0267
Singer 0099
Sony 0027, 0059, 0062, 1059
Sylvania 0027, 0062, 0070, 0108
Symphonic 0027
TMK 0267
Teac 0027
Technics 0062, 0189
Teknika 0027, 0062, 0064
Thomas 0027
Tivo 0645
Toshiba 0070, 0072
Totevision 0064, 0267
Unitech 0267
Vector 0072
Video Concepts 0072
Videasonic 0267
Wards 0027, 0062, 0069, 0074, 0075, 0087, 0099, 0108, 0267
White Westinghouse 0099, 0236, 0305
XR-1000 0027, 0062, 0099
Zenith 0027, 0066, 0236, 0506

DVD

Aiwa	0668
Apex	0699
Denon	0517, 0661
Fisher	0697
GE	0549
Harman/Kardon	0609
Hitachi	0691
Hiteker	0699
JVC	0585, 0650
Kenwood	0561, 0709
Magnavox	0530, 0702
Marantz	0566
Mitsubishi	0548
Onkyo	0530, 0654
Optimus	0598
Oritron	0678
Panasonic	0517, 0659
Philips	0530, 0566
Pioneer	0552, 0598, 0659
Proscan	0549
RCA	0549, 0598
Samsung	0600
Sharp	0657
Sony	0560
Technics	0517
Theta Digital	0598
Toshiba	0530
Yamaha	0517, 0572
Zenith	0530, 0618

TECHNICAL SPECIFICATIONS

FM TUNER SECTION

Frequency Range	87.5 - 108.0 MHz
Usable Sensitivity	IHF 1.8 μ V/16.4 dBf
Signal to Noise Ratio	Mono/Stereo 70/65 dB
Distortion	Mono/Stereo 0.2/0.3 %
Stereo Separation	1 kHz 45 dB
Alternate Channel Selectivity	\pm 300 kHz 60 dB
Image Rejection	98 MHz 70 dB
Tuner Output Level	1 kHz, \pm 40 kHz Dev 600 mV

AM TUNER SECTION

Frequency Range	LW: 152 - 282 kHz, MW: 531 - 1602 kHz
Signal to Noise Ratio	50 dB
Usable Sensitivity	Loop 400 μ V/m
Distortion	400 Hz, 30 % Mod. 0.5 %
Selectivity	\pm 18 kHz 60 dB

AUDIO SECTION

Maximum Power Output (6 ohms / EIAJ)	
Front	100W
Center	100W
Surround	100W
Continuous Power Output (8 ohms / 20 Hz - 20 kHz)	
Front	70W
Center	70W
Surround	70W
THD Front (20 Hz - 20 kHz)	8 ohms 0.09 %
Input Sensitivity/Impedance	
Linear	316 mV/ 47 Kohms
Signal to Noise Ratio	
Linear	99 dB

VIDEO

Input Level/Impedance	1 Vp-p/ 75 ohms
Output Level/Impedance	1 Vp-p/ 75 ohms

GENERAL

Power Requirement	AC 230 V 50 Hz
Power Consumption	280 W
Dimension (MAX)	
Width	440 mm
Height	164 mm
Depth	365 mm
Weight	9.7 Kg

ACCESSORIES

Remote Control Unit RC5200SR	1
AAA-size batteries	2
FM Lead Type Antenna	1
AM Loop Antenna	1
AC Power Cord	1
Registration Card	1
User Guide	1

Specifications subject to change without prior notice.

COUNTRY	COMPANY	ADDRESS
ALGERIE	Azur 2000	8, Lotissement Ben Hatadi, Alger, Algeria
ARMENIA	NGYIG Ltd.	47 A/75 St. Lalaiants, 375000 Yerevan, Armenia
AUSTRALIA	Jamo Australia Pty. Ltd.,	24 Lionel Road, Mt. Waverley, VIC 3149, Australia
AUSTRIA	Huber & Prohaska GmbH	Taborstraße 95 / Ladestraße 1, Gebäude Hangartner, A-1200 Wien, Austria
BAHREIN	Ambassador Stores	P.O. Box 237,141, Government Avenue, Manama,Bahrein
BANGLADESH	Target	1078, Ramjoy Mohanja Lane Asadgonj, Chittagong 4000, Bangladesh
BELGIUM	Van der Heyden Audio N.V.	Brusselbaan 278, 9320 Erembodegem, Belgium
BULGARIA	Ariescommerce GmbH	Makedonia Blvd. 16, 1606 Sofia, Bulgaria
CANADA	Lenbrook Industries Limited	633 Granite Court, Pickering, Ontario
CHINA	Guang Chang Audio International Co., Ltd.	No.38 Yushan Road, ShiQiao, Pan Yu, Guang Dong, China
CYPRUS	Empire Hifi systems Ltd.	P.O. Box 5604, Nicosia, Cyprus
CZECH REPUBLIC	Audio International	Sokolska 41, 67902 Rajecko, OKR,Blansko, Czech Republic
DENMARK	Audio Nord	Dali Allé 1, 9610 Noerager, Denmark
DUBAI	V.V. & SONS	P.O. Box 105, Dubai, U.A.E.
EGYPT	Solimco	9, El Attibaa St. Doki, Cairo, Egypt
ESTONIA	HiFi Club Estonia	Ehte 4, 90503 Haapsalu, Estonia
F.Y.R.O.M.	T.P. KODI	ul.Cedomir Kantargiev 21a, Skopje, Former Yugoslavian Republic of Macedonia
FINLAND	Audio Nord	Uudenmaankatu 4-6, Helsinki SF-00120, Finland
FRANCE	Marantz France	A division of Marantz Europe B.V., P.O. Box 301, 92 156 Suresnes Cedex, France
GERMANY	Marantz Deutschland	Hakenbusch 3, 49078 Osnabrück, Germany
GREECE	Adamco S.A.	188, Hippocratous Street, 11471 Athens, Greece
HEADQUARTERS EUROPE:	Marantz Europe B.V.	Building SFF-2, P.O. Box 80002, 5600 JB Eindhoven, The Netherlands
HONG KONG	Marantz Asia Ltd.	Unit 1706, Metroplaza II, 223 Hing Fong Road, Kwai Fong, N.T., Kowloon, Hong Kong
HUNGARY	Infovox Ltd.	Terez Krt.31, 1067 Budapest, Hungary
ICELAND	ID Electronics Ltd.	Armula 38, 108 Reykjavik, Iceland
INDIA	NOVA Audio Private	8,Punam Co-op.Society 29/30 Road#5, Union Park MUMBAI 400052, India
IRAN	Home Co.	5th floor no 878 Philips Building Enghelab ave, P.O. 11365/7844 Tehran, Iran
IRELAND	Marantz Ireland	Clonskeagh, Dublin 14, Ireland
ISRAEL	Elmor Ltd.	52 Heh Beiyar Street, Kikar Hamedina, Tel Aviv, Israel
ITALY	Marantz Italy	Via Casati 23, 20052 Monza (Milano), Italy, Servizio Consumatori 1678-20026, Numero Verde
IVORY COAST	Hifivoir	B.P. 2428, Abidjan 01, Ivory Coast
JAPAN	Marantz Japan Inc.	35-1 Sagami Ohno 7-Chome, Sagamihara-shi, Kanagawa 228-8505, Japan
KOREA	Mk Enterprises Ltd.	121-210, 2F Shinhan Bldg., 247-17 Seokyo-dong, Mapo-ku, Seoul, Korea
KUWAIT	alAlamiah Electronics Intl.	P.O. Box 8196, Salmiah 22052, Kuwait
LATVIA	Ace Ltd.	61, LacPlesa Str., Riga LV 1011, Latvia
LEBANON	AZ Electronics S.A., 1,	P.O. Box 11 2833, Beirut, Lebanon
LITHUANIA	Accapella Ltd.	Ausros, Vartu G/5, Pasazo SKG., 2001 Vilnius, Lithuania
MALAYSIA	Wo Kee Hong Electronics Sdn. Bhd.	Suite 8.1, Level 8, Menara Genesis, No. 33, Jalan Sultan Ismail, 50250 Kuala Lumpur, Malaysia
MALTA	Doneo Co Ltd.	78 The Strand, Sliema SLM07, Malta
MAURITIUS	SKR Electronics Ltd.	P.O. Box 685, Bell Village, Port Louis, Mauritius
MILITARY MARKET EUROPE	PASCO GmbH	PO BOX 1280, Sandhausen 69200, Germany
NETHERLANDS	Marantz Domestic Sales	A division of Marantz Europe B.V., Building SFF2, P.O. Box 80002, 5600 JB Eindhoven, The Netherlands
NEW ZEALAND	Wildash Audio Systems	14 Malvern Road, Mt. Albert, Auckland, New Zealand
NORWAY	Audio Nord	Sandkerveien 64, Oslo 0483, Norway
OMAN	Mustafa & Jawad Trading CO.	P.O. Box 1918, Ruwi, Oman
POLAND	Philips Polska Sp. z.o.o.	Al.Jerozolimskie 195b, 02 222 Warszawa, Poland
PORTUGAL	Corel2	Comércio de Electrónica Lda., Av. Luís Bivar, No 85 A, 1050 Lisboa, Portugal
PROFESSIONAL EUROPE	Marantz Professional Products	Kingsbridge House, Padbury Oaks, 575-583 Bath Road, Longford, Middlesex UB7 0EH, U.K.
PROFESSIONAL U.S.A.	Marantz Professional Products	Distributed by: Superscope Technologies Inc., 1000 Corporate Blvd. Ste.D, Aurora, Illino
QATAR	Almana & Partners W.W.L.	P.O. Box 49, Doha, Qatar
REUNION	Vision +	180 Rue du Marechal Leclerc, 97400 Saint Denis, Ile de la Reunion
ROMANIA	Nova Music Entertainment	5, Zagazului Str. Bl.1G,apt.18, sector 1,Bucharest, Romania
RUSSIA	Absolute Audio	7/2, Montazhnaya Street, 107497 Moscow, Russia
SAUDI ARABIA	Adawlia Univ. Electr. Apl	P.O. Box 2154, Alkhobar 31952, Saudi Arabia
SINGAPORE	Wo Kee Hong Distribution PTE Ltd.	130 Joo Seng Road, #03-02 Olivine Building, Singapore 368357
SLOVAKIA	Bis Audio s.r.o.	Nam. SNP 10, 96001 Zvolem, Slovakia
SLOVENIA	Bofex	Smartinska 152, HALA V/3, 61000 Ljubljana, Slovenia
SOUTH AFRICA	Coherent Imports (PTY) Ltd.	P.O. Box 1614, Alberton, 1450, South Africa
SPAIN	Marantz Spain	Martinez Villergas 2, Apartado 2065, Madrid 28027, Spain
SRI LANKA	The listening Room	Mezzanine Floor, The Landmark 385, Galle Road, Colombo - 3, Sri Lanka
SWEDEN	Audio Nord	Almedalsvagen 4, Gotenborg 402-23, Sweden
SWITZERLAND	Sound Company AG	Postfach, 8010 Zürich, Switzerland
SYRIA	Hamzeh & Partners	Hafez Ibrahim Str. No 117, Damascus Shalan, Syria
TAHITI	Covecolor	Av. Prince Hinoi, Cours de l'union sacré, P.O. Box 2334, Papeete, Tahiti
TAIWAN	Pai-Yuing Co. Ltd.	6th No 148 Sung Kiang Road, Taipei 10429, Taiwan R.O.C.
THAILAND	MRZ Standard Co. Ltd.	746-750 Mahachai Road, Wangburapa, Bangkok 10200, Thailand
TUNESIA	Societe EDEVIG	40, Avenue du Golfe Arabe, El Menzah, 1004, Tunesia
TURKEY	Türk Philips Ticaret A.S.	Yukari Dudullu Organize sanayi Bolgesi, 2.Cadde no.28, 81260 Umraniye-Istanbul, Turkey
U.K.	Marantz Hifi UK Ltd.	Kingsbridge House, Padbury Oaks, 575-583 Bath Road, Longford, Middlesex UB7 0EH, U.K.
U.S.A.	Marantz America Inc.	440 Medinah Road, Roselle, IL 60172, U.S.A.
YUGOSLAVIA	ITM Company	Omladinskih Brigada 86, 11070 Belgrade, Yugoslavia
EXPORT	Marantz Domestic Sales	A division of Marantz Europe BV,Building SFF2, P.O. Box 80002, 5600 JB Eindhoven, The Netherlands

www.marantz.com

Manufactured under license from Dolby Laboratories. "Dolby", "Pro Logic", and the double-D symbol are trademarks of Dolby Laboratories. Confidential unpublished works. Copyright 1992-1997 Dolby Laboratories. All rights reserved.

"DTS" and "DTS Digital Surround" are registered trademarks of Digital Theater Systems, Inc.

marantz® is a registered trademark.

