



marantz®

Integrated Amplifier
PM8006

You can print more than one page of a PDF onto a single sheet of paper.

Owner's Manual

[Front panel](#)

[Rear panel](#)

[Remote control
unit](#)

[Index](#)



Accessories	4
Inserting the batteries	5
Operating range of the remote control unit	5
Features	6
High quality sound	6
High performance	7
Easy operation	7
Part names and functions	8
Front panel	8
Rear panel	10
Remote control unit	12

Connections

Connecting speakers	16
Speaker A/B connection	18
Bi-wiring connection	19
Connecting a playback device	20
Connecting a recording device	21
Connecting a pre-amplifier or power amplifier	22
Connecting devices with remote control connectors	23
Performing operations by RC on this unit without visual contact	23
Remotely connecting Marantz audio devices	23
Connecting the power cord	24

Playback

Turning the power on	26
Switching the power to standby	26
Selecting the speakers for audio output	27
Selecting the input source	27
Adjusting the volume	27
Turning off the sound temporarily (Muting)	27
Adjusting the tone	28
Playing CDs	28
Recording	29



Settings

Setting the Auto Standby mode	31
Turning Auto Standby mode off	31
Turning Auto Standby mode on	31
Setting the power amp direct mode	32
Turning power amp direct mode on	32
Turning power amp direct mode off	32

Tips

Tips	34
Troubleshooting	35
Power does not turn on / Power is turned off	36
Operations cannot be performed through the remote control unit	37
No sound comes out	38
Desired sound does not come out	38
Sound is interrupted or noise occurs	39

Appendix

Explanation of terms	40
Trademark information	40
Specifications	41
Index	44





Thank you for purchasing this Marantz product.

To ensure proper operation, please read this owner's manual carefully before using the product.

After reading this manual, be sure to keep it for future reference.

Accessories

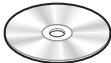
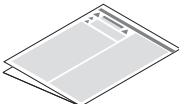
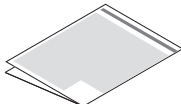
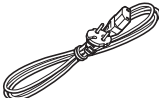
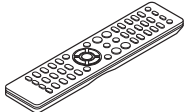
Check that the following parts are supplied with the product.

 Quick Start Guide	 CD-ROM (Owner's Manual)	 Safety Instructions	 Cautions on Using Batteries
 Power cord	 Remote control unit (RC001PMND)	 R03/AAA batteries	



Inserting the batteries

- 1 Remove the rear lid in the direction of the arrow and remove it.

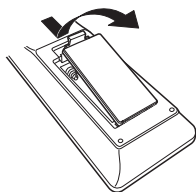

- 2 Insert two batteries correctly into the battery compartment as indicated.

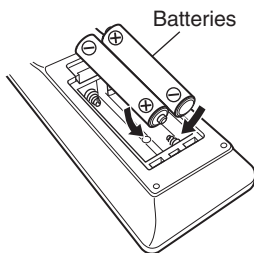

- 3 Put the rear cover back on.

NOTE

- To prevent damage or leakage of battery fluid:
 - Do not use a new battery together with an old one.
 - Do not use two different types of batteries.
- Remove the batteries from the remote control unit if it will not be in use for long periods.
- If the battery fluid should leak, carefully wipe the fluid off the inside of the battery compartment and insert new batteries.

Operating range of the remote control unit

Point the remote control unit at the remote sensor when operating it.

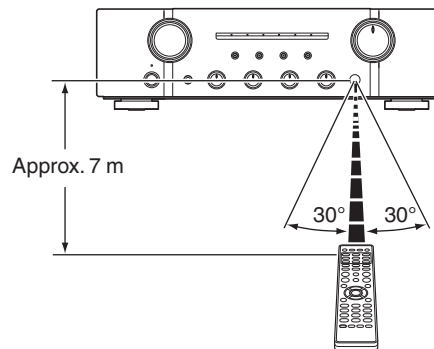

Features

High quality sound

- **All-discrete current feedback amplifier**

Marantz proprietary current-feedback circuit, using discrete components, is adopted in the pre-amplifier and power amplifier. It is a high-speed amplifier using the technology developed for the higher-grade amplifiers.

- **HDAM®SA3 Module**

This unit includes the HDAM®SA3 which had been developed for highend models. The HDAM®SA3 is incorporated into many components, such as the current feedback phono equalizer.

- **Improved momentary current supply ability**

It is generally known that the sound quality is not necessarily the same even if amplifiers have the same specifications. Marantz considers the cause to be the power to drive speakers. The power amplifier of this unit has the ability to momentarily supply current of 45 A or more to drive speakers strongly.

- **Short-power-line layout**

For strong momentary current supply, a short power-line layout unifies the power circuit and output stage of the power amplifier section. This layout allows connecting the large-current lines via the shortest route while to arranging the left and right channels symmetrically.

- **CD direct buffer amplifier**

An input buffer amplifier exclusive for CD is mounted near the CD input jacks. This is a high-speed buffer amplifier made with discrete components, which avoids interference between right and left channels and can send the signals to the pre-amplifier with very high fidelity.

- **Newly developed circuit**

As a phono equalizer amplifier for MM cartridges, new phono equalizer circuit has been developed for PM8006.



- **Double-shielded triodal transformer**

The unit is equipped with a toroidal power transformer to minimize vibration and leakage flux specific to the transformer. Especially to reduce leakage flux, which affects sound quality, the periphery is double-shielded, using a core ring and a short ring.

- **Block condenser of large capacity**

The unit is equipped with a newly developed 18000 μF large capacity condenser that incorporates the concepts of high-end devices into the power amplifier power circuit.

- **Tripple layer bottom plate to minimize vibration**

High performance

- **Tri-tone control**

This unit is equipped with a tone control function that enables adjustment of the strength of the mid range as well as the low and high ranges. (🔍 p. 28)

- **Power Amplifier Direct In Mode**

In this mode, this unit works as a power amplifier.

- **Two-sets of speaker output terminals**

In addition to using two sets of speakers (Speakers A and Speakers B), you can connect to bi-wiring speakers with separate input terminals for high range and low range. (🔍 p. 19) The unit adopts screw terminals that can connect thick audio cables.

Easy operation

- **System remote control**

This unit comes with a system remote control that can also operate the Marantz's Network CD Player ND8006.



Part names and functions

Front panel

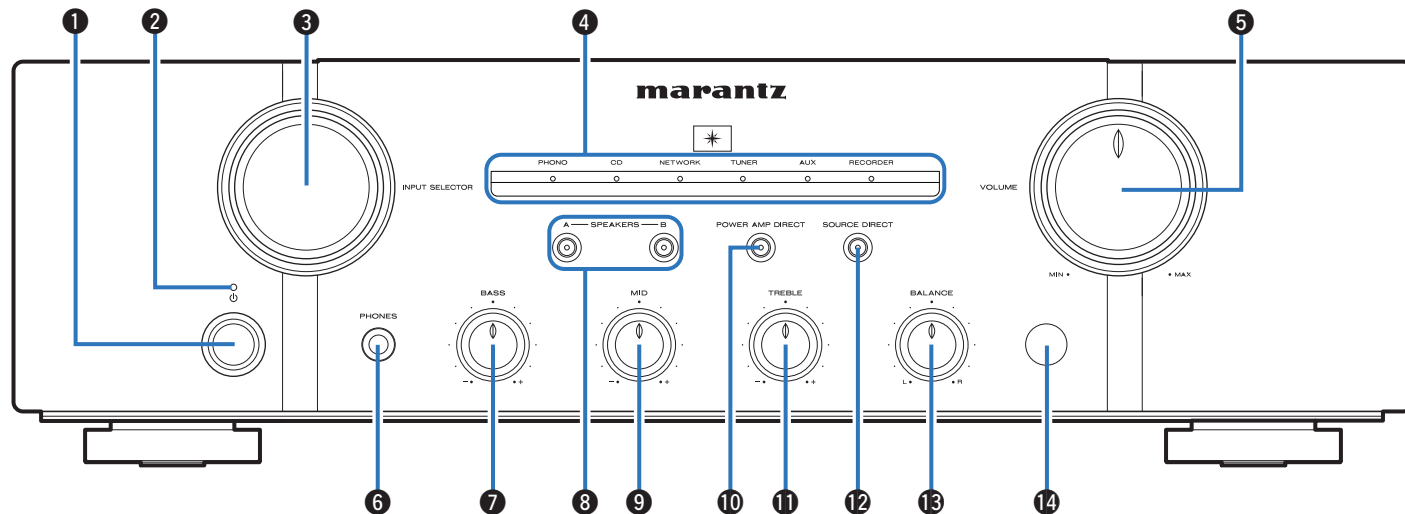

1 Power operation button (⏻)

This turns the power on/off. (📖 p. 26)

2 Power indicator

This is lit as follows according to the power status:

- Power on : Off
- Standby : Red
- Power off : Off



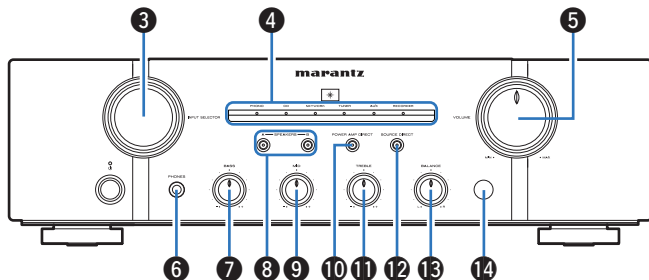

③ INPUT SELECTOR knob

This selects the input source. (☞ p. 27)

④ Input indicators (☞ p. 27)

⑤ VOLUME knob

These adjust the volume level. (☞ p. 27)

⑥ Headphones jack (PHONES)

Used to connect headphones.

Turn off speaker output when using headphones. (☞ p. 27)

NOTE

- To prevent hearing loss, do not raise the volume level excessively when using headphones.

⑦ BASS control knob

This setting adjusts the volume level for the bass. (☞ p. 28)

⑧ Speaker switching buttons/indicators (SPEAKERS A/B)

These select the speaker for audio output. (☞ p. 27)

⑨ MID control knob

This setting adjusts the volume level for the mid. (☞ p. 28)

⑩ Power amplifier direct mode button/indicator (POWER AMP DIRECT)

This switches the power amp direct mode on/off. (☞ p. 32)

⑪ TREBLE control knob

This setting adjusts the volume level for the treble. (☞ p. 28)

⑫ SOURCE DIRECT button/indicator

This turns source direct mode on/off. (☞ p. 28)

⑬ BALANCE control knob

This adjusts the balance of the volume output from the left and right speakers. (☞ p. 28)

⑭ Remote control sensor

This receives signals from the remote control unit. (☞ p. 5)



- ⑦, ⑨, ⑪ and ⑬ can be adjusted when ⑫ is off (Source direct mode is off).



Rear panel

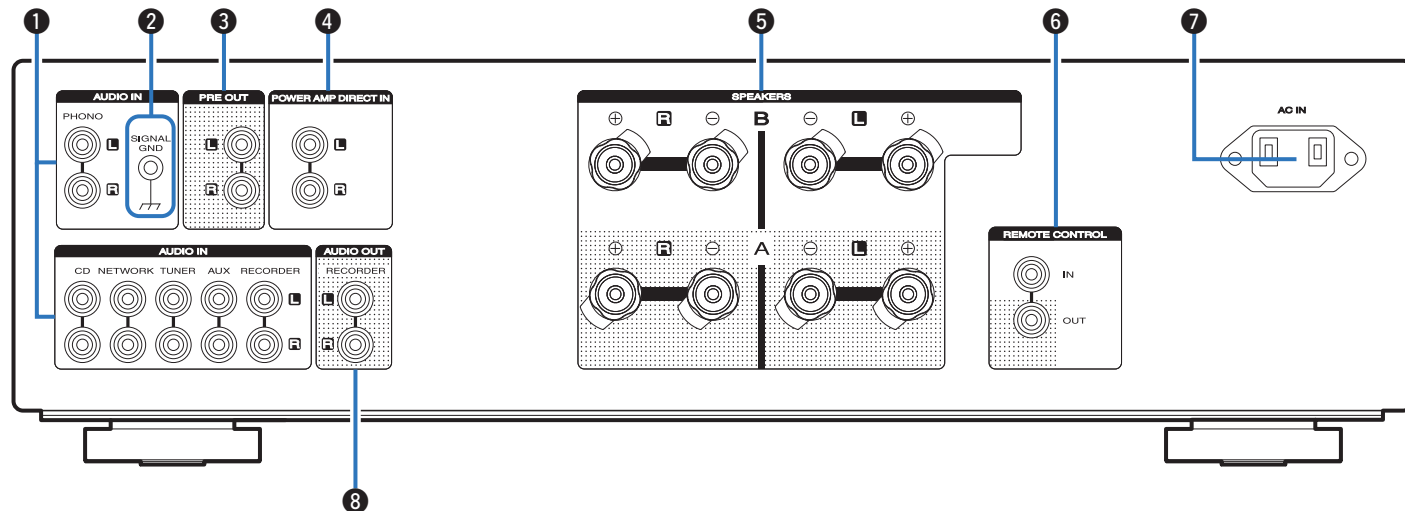

1 Analog audio input connectors (AUDIO IN)

Used to connect devices equipped with analog audio output connectors.

- “Connecting a playback device” (👉 p. 20)
- “Connecting a recording device” (👉 p. 21)

2 SIGNAL GND terminal

Used to connect the ground wire of a turntable. (👉 p. 20)



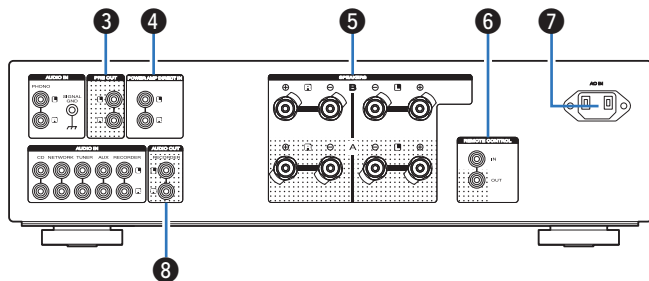

3 PRE OUT connectors

Use this to add such equipment as a power amplifier or subwoofer.

(p. 22)



- When connecting a subwoofer, also consult the subwoofer instruction manual.

4 Power amplifier direct connectors (POWER AMP DIRECT IN)

Used to connect a pre-amplifier when this unit is used as a power amplifier.

(p. 22)

5 Speaker terminals (SPEAKERS)

Used to connect speakers. (p. 16)

6 Remote control input/output connectors (REMOTE CONTROL)

Used to connect to a Marantz audio device that is compatible with the remote control function. (p. 23)

7 AC inlet (AC IN)

Used to connect the power cord. (p. 24)

8 AUDIO OUT connectors (RECORDER)

Used to connect the input connector of a recorder. (p. 21)



Remote control unit

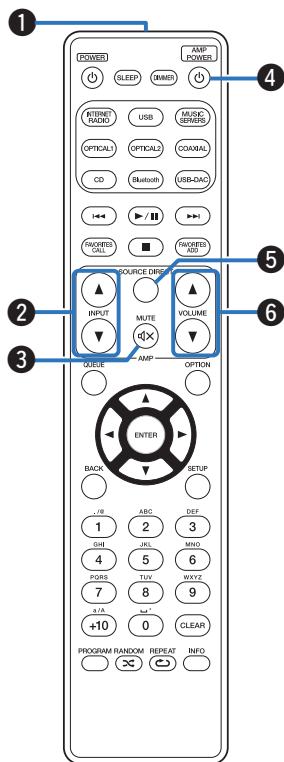

■ Operating this unit

- 1 Remote control signal transmitter**
This transmits signals from the remote control unit. (☞ p. 5)
- 2 Input source select buttons (INPUT ▲▼)**
This selects the input source. (☞ p. 27)
- 3 MUTE button (🔇)**
This mutes the output audio. (☞ p. 27)
- 4 AMP POWER button (🔌)**
This turns the power on/off (standby). (☞ p. 26)
- 5 SOURCE DIRECT button**
This turns source direct mode on/off. (☞ p. 28)
- 6 VOLUME buttons (▲▼)**
These adjust the volume level. (☞ p. 27)



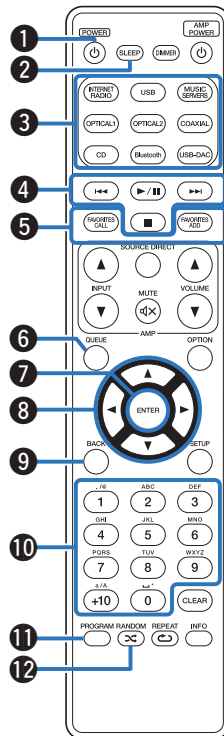

■ Network CD player operations

A Marantz Network CD player can be operated.

- 1 **POWER button (⏻)**
- 2 **SLEEP button**
- 3 **Input source select buttons**
- 4 **System buttons**
 - Skip buttons (⏮ / ⏭)
 - Play/pause button (⏪ / ⏩)
 - Stop button (■)
- 5 **FAVORITES CALL / ADD buttons**
- 6 **QUEUE button**
- 7 **ENTER button**
- 8 **Cursor buttons (⬆ / ⬇ / ⬅ / ⬇)**
- 9 **BACK button**
- 10 **Number buttons (0 – 9, +10)**
- 11 **PROGRAM button**
- 12 **RANDOM button (🎲)**



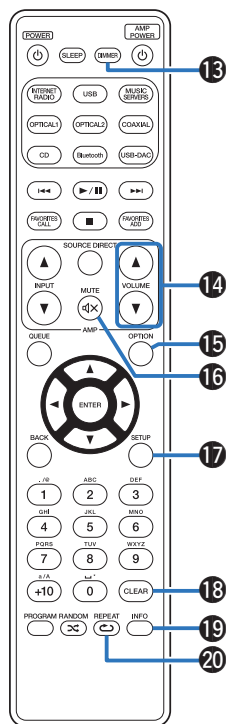

- 13 DIMMER button
- 14 VOLUME buttons (▲▼)
- 15 OPTION button
- 16 MUTE button (M)
- 17 SETUP button
- 18 CLEAR button
- 19 Information button (INFO)
- 20 REPEAT button (↺)



- The remote control may not operate some products.
- 14 and 16 only work when the remote control code is set to Network CD player operation mode. See the instruction manual of your Marantz Network CD player for details.



■ Contents

Connecting speakers	16
Connecting a playback device	20
Connecting a recording device	21
Connecting a pre-amplifier or power amplifier	22
Connecting devices with remote control connectors	23
Connecting the power cord	24

NOTE

- Do not plug in the power cord until all connections have been completed.
- Do not bundle power cords together with connection cables. Doing so can result in humming or noise.

■ Cables used for connections

Provide necessary cables according to the devices you want to connect.

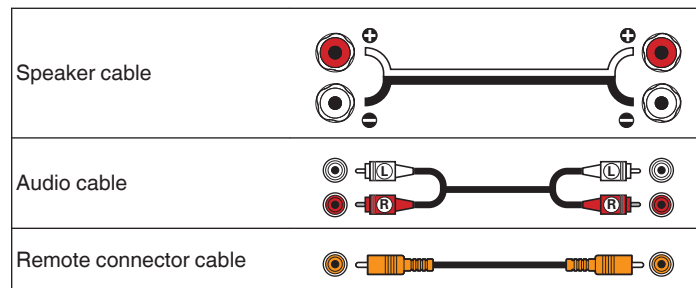

Connecting speakers

NOTE

- Disconnect this unit's power plug from the power outlet before connecting the speakers.
- Connect so that the speaker cable core wires do not protrude from the speaker terminal. The protection circuit may be activated if the core wires touch the rear panel or if the + and - sides touch each other. ("Protection circuit" (☞ p. 40))
- Never touch the speaker terminals while the power cord is connected. Doing so could result in electric shock.
- Use speakers with impedances within the ranges shown below to suit how they are used.

Speaker terminals used on this unit	No. of connected speakers	Speaker Impedance
SPEAKERS A (Standard connection)	2 (one set)	4 – 16 Ω/ohms
SPEAKERS B	2 (one set)	4 – 16 Ω/ohms
SPEAKERS A and SPEAKERS B	4 (two sets)	8 – 16 Ω/ohms
SPEAKERS A and SPEAKERS B (Bi-wiring connection)	2 (one set)	4 – 16 Ω/ohms

■ Connecting the speaker cables

Carefully check the left (L) and right (R) channels and + (red) and - (white) polarities on the speakers being connected to this unit, and be sure to connect the channels and polarities correctly.

- 1 Peel off about 10 mm of sheathing from the tip of the speaker cable, then either twist the core wire tightly or terminate it.**



- 2 Turn the speaker terminal counterclockwise to loosen it.**



- 3 Insert the speaker cable's core wire to the hilt into the speaker terminal.**

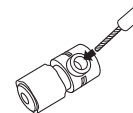

4 Turn the speaker terminal clockwise to tighten it.



Spade lug connector

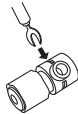

Speaker A/B connection

This unit is equipped with two sets of speaker terminals (SPEAKER A and SPEAKER B). One set of speakers can be connected to each set of terminals, and a total of two sets of speakers can be connected.

The same signal is output from the SPEAKERS A and SPEAKERS B terminals.

When only one set of speakers is to be connected, use either the SPEAKERS A or SPEAKERS B terminals.

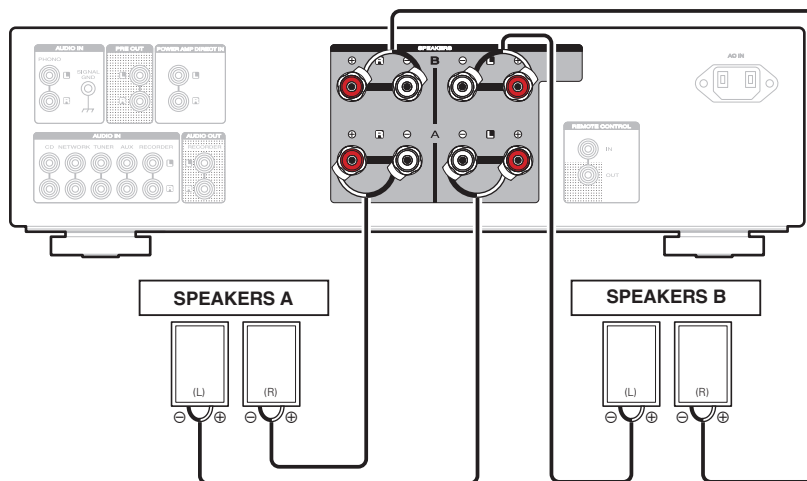

Bi-wiring connection

This connection limits the effects of signal interference between the high range speakers (tweeters) and low range speakers (woofers), allowing you to enjoy high quality playback.

When bi-wiring with bi-wireable speakers, connect the mid and high range terminals to SPEAKERS B (or SPEAKERS A), the low range terminals to SPEAKERS A (or SPEAKERS B).

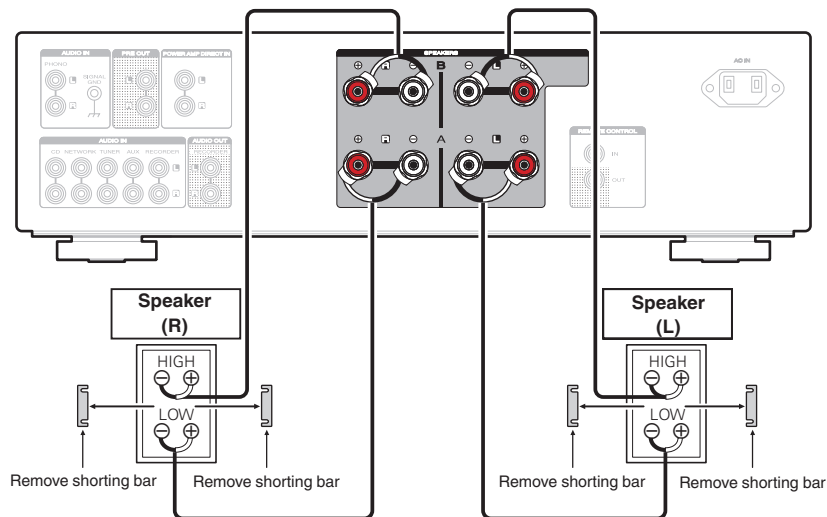

Connecting a playback device

You can connect turntables, tuners, Blu-ray disc players, network audio players and CD players to this unit.

This unit is compatible with turntables equipped with a moving magnet (MM) phono cartridge. When you connect to a turntable with a low output moving coil (MC) cartridge, use a commercially available MC head amp or a step-up transformer.

If you set this unit's input source to "PHONO" and you accidentally increase the volume without having a turntable connected, you may hear a hum noise from the speakers.

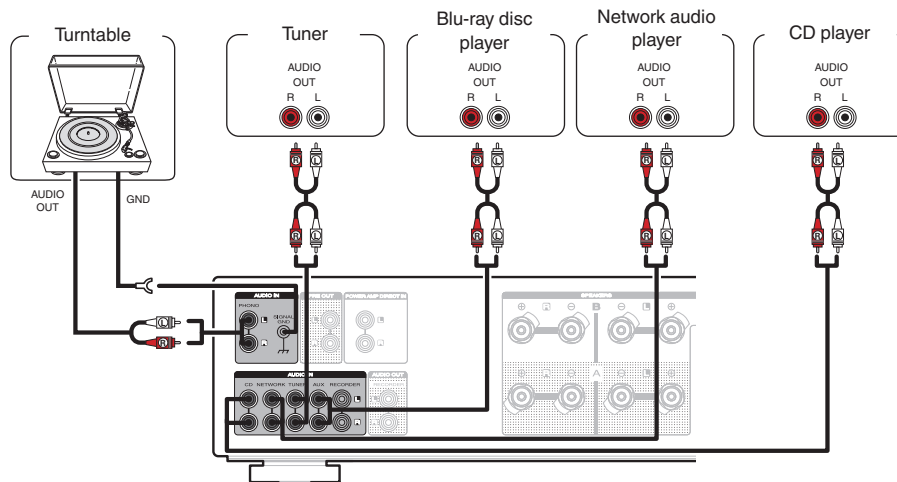

NOTE

- The earth terminal (SIGNAL GND) of this unit is not for safety grounding purposes. If this terminal is connected when there is a lot of noise, the noise can be reduced. Note that depending on the turntable, connecting the ground line may have the reverse effect of increasing noise. In this case, it is not necessary to connect the ground line.



Connecting a recording device

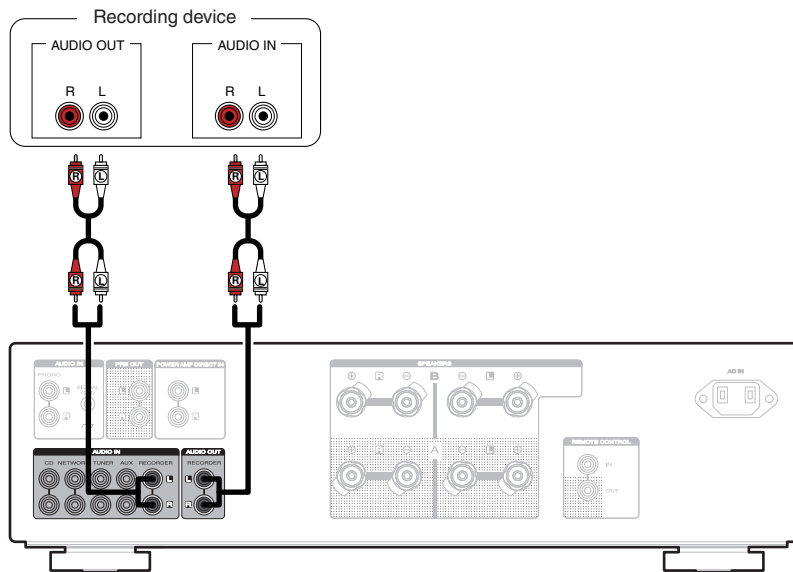

NOTE

- Never insert the short-circuiting pin plug into the recording output connectors (AUDIO OUT RECORDER). Doing so could result in damage.



Connecting a pre-amplifier or power amplifier

Connect a power amplifier to the unit to use it as a pre-amplifier, or connect a pre-amplifier to the unit to use it as a power amplifier.

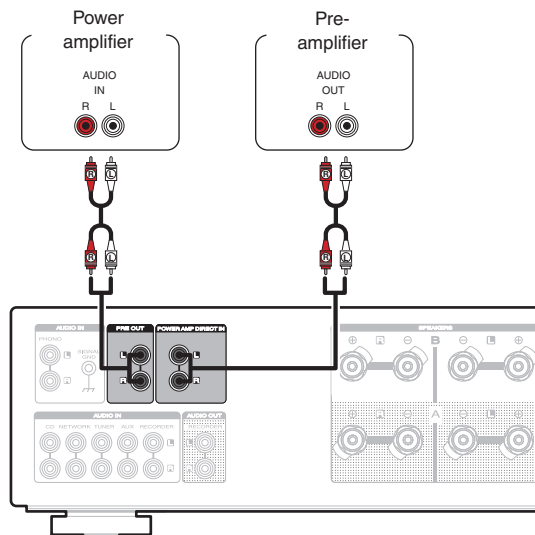

- When a pre-amplifier is connected to this unit and the unit is used as a power amplifier, turn power amp direct mode on. (🔍 p. 32)

NOTE

- Never insert the short-circuiting pin plug into the PRE OUT terminals. Doing so could result in damage.



Connecting devices with remote control connectors

Performing operations by RC on this unit without visual contact

You can connect an external IR receiver to the REMOTE CONTROL connectors to perform operations on this unit with the supplied remote control unit without visual contact. This might be necessary if the unit is hidden in a cupboard or corner, so you can't directly point with the remote control unit to the device.

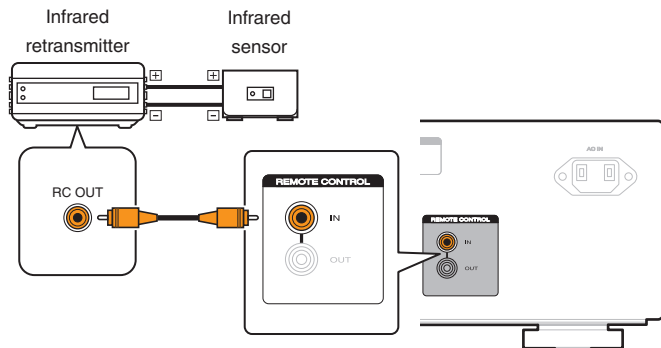

Remotely connecting Marantz audio devices

You can transmit remote control signals simply by connecting a Marantz audio device to the REMOTE CONTROL IN/OUT connectors using the remote connection cable provided with the device.

Set the remote control switch located on the rear panel of the connected audio component to "EXTERNAL" to use this feature.

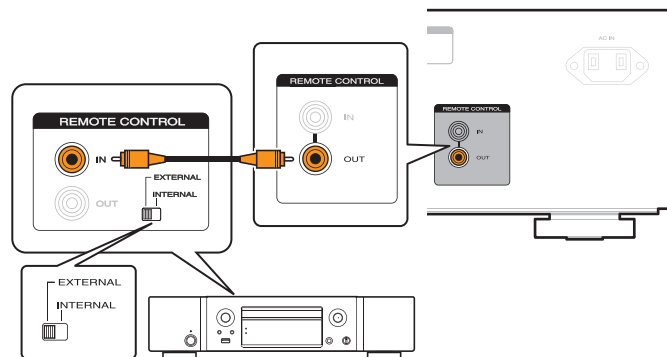

Connecting the power cord

After completing all the connections, insert the power plug into the power outlet.

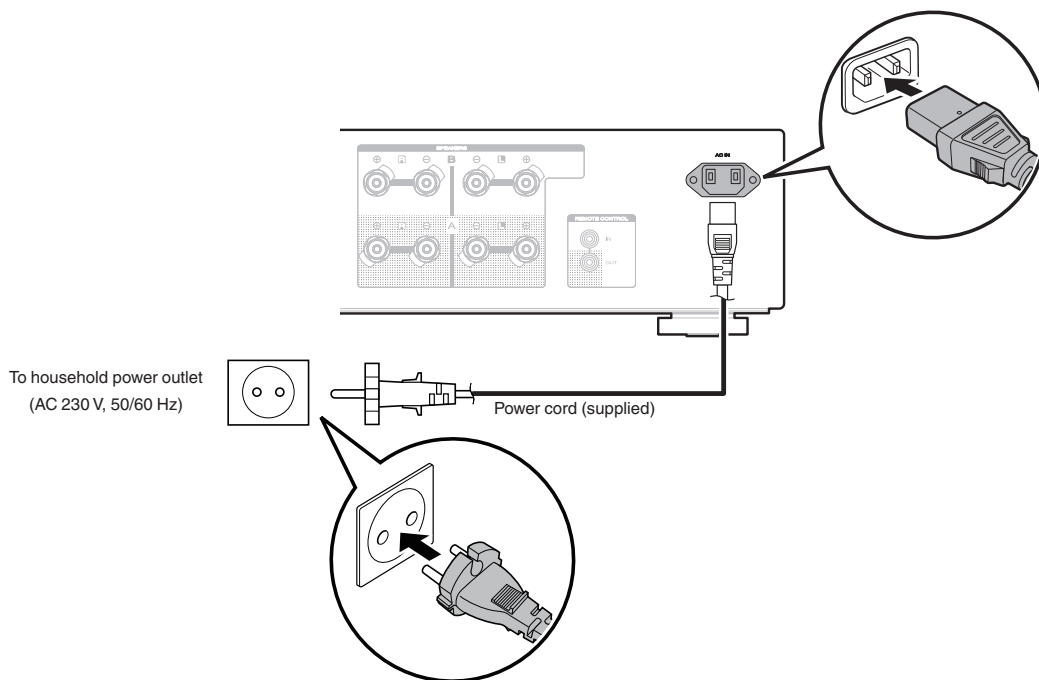

■ Contents

Turning the power on	26
Switching the power to standby	26
Selecting the speakers for audio output	27
Selecting the input source	27
Adjusting the volume	27
Turning off the sound temporarily (Muting)	27
Adjusting the tone	28
Playing CDs	28
Recording	29



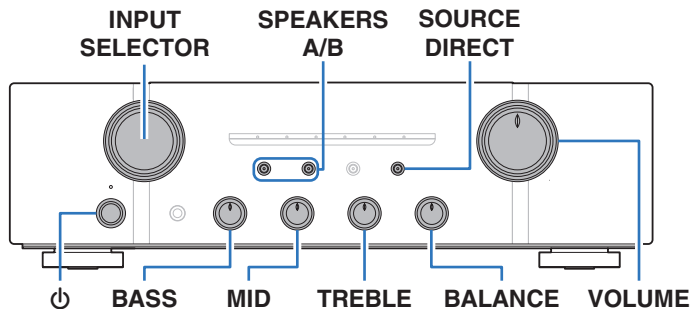
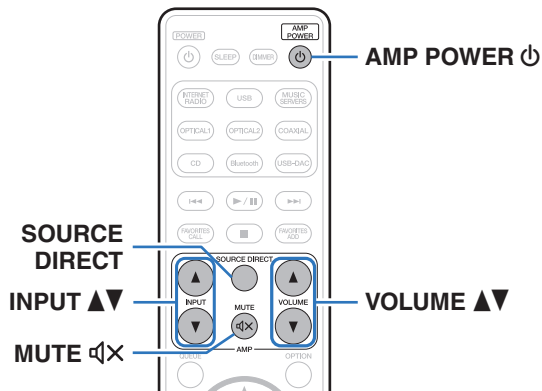

Turning the power on

1 Press on the main unit to turn the power on.

Input indicator for the selected source lights in blue.



- Press AMP POWER  on the remote control unit to turn on power from standby mode.
- You can also turn the INPUT SELECTOR on the main unit when the unit is in standby mode to turn on the power.

NOTE

- Turn VOLUME on the main unit to adjust the volume to the lowest level before turning on the power.

Switching the power to standby

1 Press AMP POWER on the remote control unit.

The power indicator lights in red.

NOTE

- Power continues to be supplied to some of the circuitry even when the power is in the standby mode. When leaving home for long periods of time or when going on vacation, either press  on the main unit to turn off the power, or unplug the power cord from the power outlet.



Selecting the speakers for audio output

- 1 Use **SPEAKERS A/B** on the main unit to select the speaker system to be used for playback.

The indicator of the selected speakers lights.



- When using headphones, press **SPEAKERS A/B** to turn off all of the indicators and turn audio output from the speaker terminals off.

Selecting the input source

- 1 Use **INPUT ▲▼** to select the input source to be played back.

The indicator of the selected input source lights in blue.



- You can also select the input source by turning **INPUT SELECTOR** on the main unit.

Adjusting the volume

- 1 Use **VOLUME ▲▼** to adjust the volume.



- You can also adjust the volume by turning **VOLUME** on the main unit.

Turning off the sound temporarily (Muting)

- 1 Press **MUTE** .

The indicator of the currently set input source lights in red.



- To cancel mute, press **MUTE**  again.



Adjusting the tone





- 1 Press SOURCE DIRECT to turn off source direct mode.**
The SOURCE DIRECT indicator turns off.
- 2 Turn the BASS, MID, TREBLE and BALANCE on this unit to adjust the tone.**



- You can also press SOURCE DIRECT on the main unit to turn off source direct mode.

Playing CDs

This section uses playback from a CD as an example.

- 1 Press  on the main unit to turn the power on.**
- 2 Use INPUT   to switch the input source to “CD”.**
The “CD” input indicator lights in blue.
- 3 Playback the CD.**
- 4 Use VOLUME   to adjust the volume.**

■ Playback in source direct mode



The signal does not pass through the tone adjustment circuitry (BASS, MID, TREBLE and BALANCE), resulting in playback of a higher sound quality.

- 1 Press SOURCE DIRECT to turn on source direct mode.**
The SOURCE DIRECT indicator lights.



Recording

Audio signals input into this unit can be output to an external recording device. When recording audio from a playback device connected to this unit, audio can be recorded with the playback device still connected to this unit.

- 1 Press  on the main unit to turn the power on.**
- 2 Use INPUT   to switch to the input source from which you want to record.**

The indicator of the selected input source lights in blue.

- 3 Recording starts.**

- For information on operations, see the owner's manual of the recording device.



■ Contents

Setting the Auto Standby mode	31
Setting the power amp direct mode	32



Setting the Auto Standby mode

You can set the unit to automatically switch to standby mode if the unit is not operated for 30 minutes when there is no audio input (Auto Standby mode).

Auto Standby mode is set to on by default.

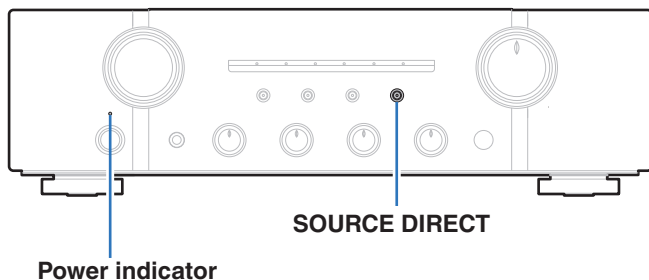

Turning Auto Standby mode off

- 1 Press and hold **SOURCE DIRECT** on the main unit for more than 5 seconds to turn the Auto Standby mode off. The power indicator flashes once.

Turning Auto Standby mode on

- 1 Press and hold **SOURCE DIRECT** on the main unit for more than 5 seconds to turn the Auto Standby mode on. The power indicator flashes three times.



Setting the power amp direct mode

When a pre-amplifier is connected to this unit and the unit is used as a power amplifier, follow the instructions below to turn power amp direct mode on.

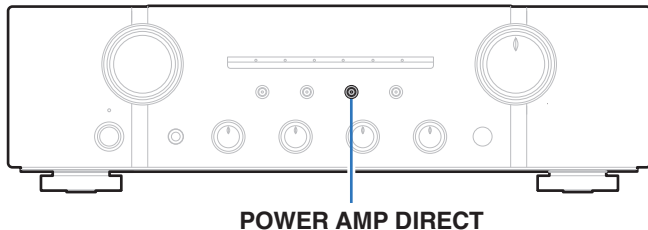

Turning power amp direct mode on

- 1 Press and hold POWER AMP DIRECT for more than 3 seconds to turn the power amp direct mode on.**

The power amp direct indicator lights and the power amp direct mode turns on. The input source switching function of the unit is disabled, and the device connected to the power amp direct input terminal is played back.

Turning power amp direct mode off

- 1 Press and hold POWER AMP DIRECT for more than 3 seconds to turn the power amp direct mode off.**

The power amp direct indicator turns off and the power amp direct mode turns off.

NOTE

- When the power amp direct mode is on, adjustment of the volume, balance and tone has no effect. Adjust the volume on the pre-amplifier.
- The input source cannot be switched when power amp direct mode is on.
- When the power amp direct mode is on, the main unit outputs at maximum volume. Check the output level on the input device before playing it and adjust the volume accordingly.



■ Contents

Tips

I want to adjust the tone myself	34
I want sound playback that is faithful to the original sound	34
I want to use bi-wiring compatible speakers	34
I want to operate a Marantz Network CD player using the remote control of this unit	34
I want to use this unit as a power amplifier	34
I want to use this unit as a pre-amplifier	34

Troubleshooting

Power does not turn on / Power is turned off	36
Operations cannot be performed through the remote control unit	37
No sound comes out	38
Desired sound does not come out	38
Sound is interrupted or noise occurs	39



Tips

I want to adjust the tone myself

- Use the BASS, MID, TREBLE and BALANCE knobs to adjust the sound as desired. ( [p. 28](#))

I want sound playback that is faithful to the original sound

- Set the source direct mode on. ( [p. 28](#))

I want to use bi-wiring compatible speakers

- This unit is compatible with bi-wiring connections. Enjoy high quality playback by using bi-wiring connections. ( [p. 19](#))

I want to operate a Marantz Network CD player using the remote control of this unit

- Marantz Network CD Players can also be operated with the remote control of this unit. Also refer to the Network CD player's instruction manuals. ( [p. 13](#))

I want to use this unit as a power amplifier

- Set the power amp direct mode on. ( [p. 32](#))

I want to use this unit as a pre-amplifier

- Connect a power amplifier to the pre out connectors of this unit. ( [p. 22](#))



Troubleshooting

If a problem should arise, first check the following:

1. **Are the connections correct?**
2. **Is the set being operated as described in the owner's manual?**
3. **Are the other devices operating properly?**

If this unit does not operate properly, check the corresponding symptoms in this section.

If the symptoms do not match any of those described here, consult your dealer as it could be due to a fault in this unit. In this case, disconnect the power immediately and contact the store where you purchased this unit.



Power does not turn on / Power is turned off

Power is not turned on.

- Check whether the power plug is correctly inserted into the power outlet. (🔍 p. 24)

Power automatically turns off.

- The Auto Standby mode is on. When approx. 30 minutes pass with no audio input and no operations on the unit, this unit automatically enters the standby mode. To turn off the Auto Standby mode, press the SOURCE DIRECT button for 5 seconds or longer. (🔍 p. 31)

Power turns off and the power indicator flashes in red approx. every 0.5 seconds.

- The protection circuit has been activated due to a rise in temperature within this unit. Turn the power off, wait about an hour until this unit cools down sufficiently, and then turn the power on again. (🔍 p. 40)
- Please re-install this unit in a place having good ventilation.

Power turns off and the power indicator flashes in red approx. every 0.25 seconds.

- Check the speaker connections. The protection circuit may have been activated because speaker cable core wires came in contact with each other or a core wire was disconnected from the connector and came in contact with the rear panel of this unit. After unplugging the power cord, take corrective action such as firmly re-twisting the core wire or taking care of the connector, and then reconnect the wire. (🔍 p. 16)
- Turn down the volume and turn on the power again. (🔍 p. 26)

When the power is turned on, the power indicator flashes in red approx. every 0.25 seconds.

- This unit's amplifier circuit has failed. Unplug the power cord and contact our customer service center.



Operations cannot be performed through the remote control unit

Operations cannot be performed through the remote control unit.

- Batteries are worn out. Replace with new batteries. (🔍 p. 5)
- Operate the remote control unit within a distance of about 7 m from this unit and at an angle of within 30°. (🔍 p. 5)
- Remove any obstacle between this unit and the remote control unit.
- Insert the batteries in the proper direction, checking the ⊕ and ⊖ marks. (🔍 p. 5)
- The set's remote control sensor is exposed to strong light (direct sunlight, inverter type fluorescent bulb light, etc.). Move the set to a place in which the remote control sensor will not be exposed to strong light.
- When using a 3D video device, the remote control unit of this unit may not function due to effects of infrared communications between units (such as TV and glasses for 3D viewing). In this case, adjust the direction of units with the 3D communications function and their distance to ensure they do not affect operations from the remote control unit of this unit.
- The remote control code of the volume buttons on the remote control (VOLUME ▲▼ and MUTE ⏻) is set to the mode for operating a Marantz Network CD player. If the volume of this unit cannot be adjusted using the remote control, press and hold ENTER and the number 2 button together for 5 seconds or more to change the remote control code to AMP operation mode.



No sound comes out

No sound comes out of speakers.

- Check the connections for all devices. (🔍 p. 15)
- Insert connection cables all the way in.
- Check that input connectors and output connectors are not reversely connected.
- Check cables for damage.
- Check that speaker cables are properly connected. Check that cable core wires come in contact with the metal part on speaker terminals. (🔍 p. 16)
- Securely tighten the speaker terminals. Check speaker terminals for looseness. (🔍 p. 16)
- Check that the proper input source is selected. (🔍 p. 27)
- The volume is set to the minimum level. Adjust the volume to a suitable level. (🔍 p. 27)
- Cancel the muting mode. (🔍 p. 27)
- Check the settings of the SPEAKERS A/B buttons. (🔍 p. 27)

Desired sound does not come out

No sound comes out of a specific speaker.

- Check that speaker cables are properly connected. (🔍 p. 16)
- Adjust the BALANCE control knob. (🔍 p. 28)

The left and right of stereo sound is reversed.

- Check whether the left and right speakers are connected to the correct speaker terminals. (🔍 p. 18)



Sound is interrupted or noise occurs

When playing a record, the sound is distorted.

- Adjust to a proper needle pressure.
- Check the tip of the needle.
- Replace the cartridge.

When playing a record, a humming noise comes out of the speakers.

- Check that the turntable is connected correctly. (🔍 p. 20)
- If there is a TV or AV device near the turntable, such devices may affect the playback sound. Install the turntable in a location as far away as possible from the TV or other AV devices.

When playing a record, a humming noise comes out of the speakers when the volume is high. (Howling phenomenon)

- Install the turntable and speakers as far from each other as possible. (🔍 p. 20)
- The vibrations from the speakers are being transmitted to the player through the floor. Use cushions, etc., to absorb the speakers' vibrations.



Explanation of terms

Speaker impedance

This is an AC resistance value, indicated in Ω (ohms).
Greater power can be obtained when this value is smaller.

Source direct

Playback with higher fidelity to the source becomes possible, as input audio signals are output by bypassing the audio quality-control circuits (BASS/MID/TREBLE/BALANCE).

Protection circuit

This is a function to prevent damage to devices within the power supply when an abnormality such as an overload, excess voltage occurs or over temperature for any reason.

Trademark information



Adobe, the Adobe logo and Reader are either registered trademarks or trademarks of Adobe Systems Incorporated in the United States and/or other countries.



Specifications

• RMS Power output (20 Hz – 20 kHz simultaneous drive of both channels) :	70 W x 2 (8 Ω /ohms load) 100 W x 2 (4 Ω /ohms load)
• Total harmonic distortion (20 Hz – 20 kHz simultaneous drive of both channels, 8 Ω/ohms load) :	0.02 %
• Output band width (8 Ω/ohms load, 0.06 %) :	5 Hz – 60 kHz
• Frequency response (CD, 1 W, 8 Ω/ohms load) :	5 Hz – 100 kHz \pm 3 dB
• Damping factor (8 Ω/ohms load, 40 Hz – 20 kHz) :	100
• Input sensitivity/Input impedance	
PHONO (MM) :	2.0 mV/47 k Ω /kohms
CD, TUNER, NETWORK, AUX, RECORDER :	220 mV / 20 k Ω /kohms
POWER AMP DIRECT IN :	1.6 V / 15 k Ω /kohms
• Output voltage/Output impedance	
PRE OUT :	1.6 V / 600 Ω /ohms
• Maximum allowable PHONO input level (1 kHz) MM :	80 mV
• RIAA deviation (20 Hz – 20 kHz) :	\pm 0.5 dB
• S/N (IHF-A, 8 Ω/ohms load)	
PHONO (MM) :	87 dB (5 mV input, 1 W output)
CD, TUNER, NETWORK, AUX, RECORDER :	106 dB (2 V input, Rated output)
POWER AMP DIRECT IN :	125 dB (Rated output)



- **Tone Control**

BASS (50 Hz) : ±10 dB

MID (900 Hz) : ±6 dB

TREBLE (15 kHz) : ±10 dB

- **Power supply :**

AC 230 V, 50/60 Hz

- **Power consumption :**

220 W

- **Power consumption in standby mode :**

0.2 W

For the purpose of improvement, the specifications and design are subject to change without notice.



■ Dimensions (Unit : mm)

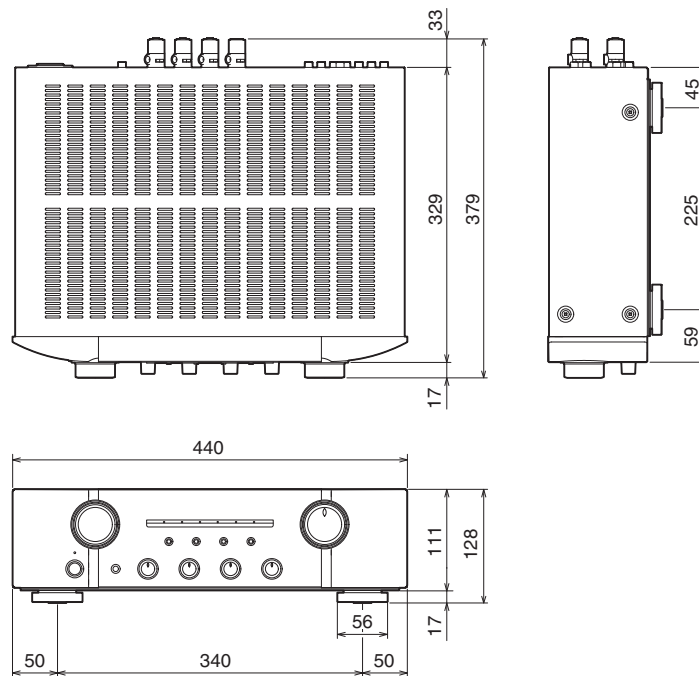

■ Weight : 12.0 kg

Index

A		M		S	
Auto Standby mode	31	Muting	27	Source direct	28, 40
B		N		Speaker impedance	40
Bi-wiring	19	Network audio player	20	Speakers	16
Blu-ray Disc player	20	P		T	
C		Power amp direct mode	32	Tips	34
CD player	20, 28	Power amplifier	22	Tone	28
F		Pre-amplifier	22	Troubleshooting	35
Front panel	8	Protection circuit	40	Tuner	20
I		R		Turntable	20
Input source	27	Rear panel	10	V	
		Recording device	21	Volume	27
		Remote control unit	12		



www.marantz.com

You can find your nearest authorized distributor or dealer on our website.

marantz[®] is a registered trademark.

3520 10571 00AMA

Copyright © 2017 D&M Holdings Inc. All Rights Reserved.