

marantz®

Model IS201 User Guide

Universal Dock

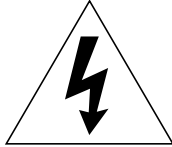

CAUTION
RISK OF ELECTRIC SHOCK
DO NOT OPEN



**CAUTION: TO REDUCE THE RISK OF ELECTRIC SHOCK,
DO NOT REMOVE COVER (OR BACK)
NO USER-SERVICEABLE PARTS INSIDE
REFER SERVICING TO QUALIFIED SERVICE PERSONNEL**

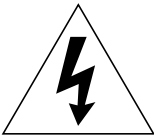

The lightning flash with arrowhead symbol within an equilateral triangle is intended to alert the user to the presence of uninsulated “dangerous voltage” within the product’s enclosure that may be of sufficient magnitude to constitute a risk of electric shock to persons.



The exclamation point within an equilateral triangle is intended to alert the user to the presence of important operating and maintenance (servicing) instructions in the literature accompanying the product.

WARNING

TO REDUCE THE RISK OF FIRE OR ELECTRIC SHOCK, DO NOT EXPOSE THIS APPLIANCE TO RAIN OR MOISTURE.

NOTE:

This equipment has been tested and found to comply with the limits for a Class B digital device, pursuant to Part 15 of the FCC Rules. These limits are designed to provide reasonable protection against harmful interference in a residential installation. This equipment generates, uses and can radiate radio frequency energy and, if not installed and used in accordance with the instructions, may cause harmful interference to radio communications. However, there is no guarantee that interference will not occur in a particular installation. If this equipment does cause harmful interference to radio or television reception, which can be determined by turning the equipment off and on, the user is encouraged to try to correct the interference by one or more of the following measures:

- Reorient or relocate the receiving antenna.
- Increase the separation between the equipment and receiver.
- Connect the equipment into an outlet on a circuit different from that to which the receiver is connected.
- Consult the dealer or an experienced radio/TV technician for help.

NOTE: Changes or modifications may cause this unit to fail to comply with Part 15 of the FCC Rules and may void the user's authority to operate the equipment.

**This Class B digital apparatus complies with Canadian ICES-003.
Cet appareil numérique de la Classe B est conforme a la norme NMB-003 du Canada.**

IMPORTANT SAFETY INSTRUCTIONS

READ BEFORE OPERATING EQUIPMENT

This product was designed and manufactured to meet strict quality and safety standards. There are, however, some installation and operation precautions which you should be particularly aware of.

1. Read these instructions.
2. Keep these instructions.
3. Heed all warnings.
4. Follow all instructions.
5. Do not use this apparatus near water.
6. Clean only with dry cloth.
7. Do not block any ventilation openings. Install in accordance with the manufacture's instructions.
8. Do not install near any heat sources such as radiators, heat registers, stoves, or other apparatus (including amplifiers) that produce heat.
9. Do not defeat the safety purpose of the polarized or grounding-type plug. A polarized plug has two blades with one wider than the other. A grounding type plug has two blades and a third grounding prong. The wide blade or the third prong are provided for your safety. If the provided plug does not fit into your outlet, consult an electrician for replacement of the obsolete outlet.
10. Protect the power cord from being walked on or pinched particularly at plugs, convenience receptacles, and the point where they exit from the apparatus.
11. Only use attachments/accessories specified by the manufacturer.
12. Use only with the cart, stand, tripod, bracket, or table specified by the manufacturer, or sold with the apparatus. When a cart is used, use caution when moving the cart/apparatus combination to avoid injury from tip-over.



13. Unplug this apparatus during lightning storms or when unused for long periods of time.
14. Refer all servicing to qualified service personnel. Servicing is required when the apparatus has been damaged in any way, such as power-supply cord or plug is damaged, liquid has been spilled or objects have fallen into the apparatus, the apparatus has been exposed to rain or moisture, does not operate normally, or has been dropped.

Additional Safety Information!

- This product should not be placed in a built-in installation such as a bookcase or rack unless proper ventilation is provided or the manufacturer's instructions have been adhered to.
- Apparatus shall not be exposed to dripping or splashing and that no objects filled with liquids, such as vases, shall be placed on the apparatus.
- The AC adaptor shall be installed near the Socket-Outlet and shall be easily accessible.

ENGLISH

WARRANTY

For warranty information, contact your local Marantz distributor.

RETAIN YOUR PURCHASE RECEIPT

Your purchase receipt is your permanent record of a valuable purchase. It should be kept in a safe place to be referred to as necessary for insurance purposes or when corresponding with Marantz.

IMPORTANT

When seeking warranty service, it is the responsibility of the consumer to establish proof and date of purchase. Your purchase receipt or invoice is adequate for your proof.

FOR U.K. ONLY

This undertaking is in addition to a consumer's statutory rights and does not affect those rights in any way.

FRANÇAIS

GARANTIE

Pour des informations sur la garantie, contacter le distributeur local Marantz.

CONSERVER L'ATTESTATION D'ACHAT

L'attestation d'achat est la preuve permanente d'un achat de valeur. La conserver en lieu sûr pour s'y reporter aux fins d'obtention d'une couverture d'assurance ou dans le cadre de correspondances avec Marantz.

IMPORTANT

Pour l'obtention d'un service couvert par la garantie, il incombe au client d'établir la preuve de l'achat et d'en corroborer la date. Le reçu ou la facture constituent des preuves suffisantes.

DEUTSCH

GARANTIE

Bei Garantiefragen wenden Sie sich bitte an Ihren Marantz-Händler.

HEBEN SIE IHRE QUITTING GUT AUF

Die Quittung dient Ihnen als bleibende Unterlage für Ihren wertvollen Einkauf. Das Aufbewahren der Quittung ist wichtig, da die darin enthaltenen Angaben für Versicherungswecke oder bei Korrespondenz mit Marantz angeführt werden müssen.

WICHTIG!

Bei Garantiefragen muß der Kunde eine Käuferunterlage mit Kaufdatum vorlegen. Ihren Quittung oder Rechnung ist als Unterlage ausreichend.

NEDERLANDS

GARANTIE

Voor inlichtingen omtrent garantie dient u zich tot uw plaatselijke Marantz.

UW KWITANTIE, KASSABON E.D. BEWAREN

Uw kwitantie, kassabon e.d. vormen uw bewijs van aankoop van een waardevol artikel en dienen op een veilige plaats bewaard te worden voor evt. verwijzing bijv. in verbend met verzekering of bij correspondentie met Marantz.

BELANGRIJK

Bij een evt. beroep op de garantie is het de verantwoordelijkheid van de consument een gedateerd bewijs van aankoop te tonen. Uw kassabon of factuur zijn voldoende bewijs.

ESPAÑOL

GARANTIA

Para obtener información acerca de la garantía póngase en contacto con su distribuidor Marantz.

GUARDE SU RECIBO DE COMPRA

Su recibo de compra es su prueba permanente de haber adquirido un aparato de valor. Este recibo deberá guardarlo en un lugar seguro y utilizarlo como referencia cuando tenga que hacer uso del seguro o se ponga en contacto con Marantz.

IMPORTANTE

Quando solicite el servicio otorgado por la garantía el usuario tiene la responsabilidad de demostrar cuándo efectuó la compra. En este caso, su recibo de compra será la prueba apropiada.

ITALIANO

GARANZIA

L'apparecchio è coperto da una garanzia di buon funzionamento della durata di un anno, o del periodo previsto dalla legge, a partire dalla data di acquisto comprovata da un documento attestante il nominativo del Rivenditore e la data di vendita. La garanzia sarà prestata con la sostituzione o la riparazione gratuita delle parti difettose.

Non sono coperti da garanzia difetti derivanti da uso improprio, errata installazione, manutenzione effettuata da personale non autorizzato o, comunque, da circostanze che non possano riferirsi a difetti di funzionamento dell'apparecchio. Sono inoltre esclusi dalla garanzia gli interventi inerenti l'installazione e l'allacciamento agli impianti di alimentazione.

Gli apparecchi verranno riparati presso i nostri Centri di Assistenza Autorizzati. Le spese ed i rischi di trasporto sono a carico del cliente.

La casa costruttrice declina ogni responsabilità per danni diretti o indiretti provocati dalla inosservanza delle prescrizioni di installazione, uso e manutenzione dettagliate nel presente manuale o per guasti dovuti ad uso continuato a fini professionali.

SVENSKA

GARANTI

För information om garantin, kontakta Marantz lokalgent.

SPAR KVITTOT

Kvittot är ett inköpsbevis på en värdefull vara. Det skall förvaras säkert och hänvisas till vid försäkringsfall eller vidkorrespondens mod Marantz.

VIKTIGT

Fö att garantin skall gälla är det kundens sak att framställa bevis och datum om köpet. Kvitto eller faktura är tillräckligt bevis fö detta.

CE MARKING

- English**
The IS201 is in conformity with the EMC directive and low-voltage directive.
- Français**
Le IS201 est conforme à la directive EMC et à la directive sur les basses tensions.
- Deutsch**
Das Modell IS201 entspricht den EMC-Richtlinien und den Richtlinien für Niederspannungsgeräte.
- Nederlands**
De IS201 voldoet aan de EMC eisen en de vereisten voor laag-voltage.
- Español**
El IS201 está de acuerdo con las normas EMC y las relacionadas con baja tensión.
- Italiano**
Il IS201 è conforme alle direttive CEE ed a quelle per i bassi voltaggi.
- Svenska**
IS201 är tillverkad i enlighet med EMC direktiven och direktiven för lågvoltsutrustning.

English

WARNINGS

- The AC adaptor shall be installed near the Socket-Outlet and shall be easily accessible.
- Do not handle the AC adaptor with wet hands.
- Do not cover the ventilation with any items such as tablecloths, newspapers, curtains, etc.
- No naked flame sources, such as lighted candles, should be placed on the equipment.

Français

AVERTISSEMENTS

- L'adaptateur secteur doit être installé à proximité de la prise secteur et doit être facilement accessible.
- Ne pas manipuler l'adaptateur secteur avec les mains humides.
- Ne pas recouvrir les ouïes de ventilation avec un objet quelconque comme une nappe, un journal, un rideau, etc.
- Ne placer aucune source de flamme nue, comme une bougie allumée, sur l'appareil.

Deutsch

WARNHINWEISE

- Der Netzadapter muss in der Nähe der Steckdose angebracht werden und leicht zugänglich sein.
- Berühren Sie den Netzadapter nicht mit nassen Händen.
- Decken Sie die Lüftungsöffnungen nicht mit einem Tischtuch, einer Zeitung, einem Vorhang usw. ab.
- Es dürfen keine Gegenstände mit offener Flamme, wie etwa brennende Kerzen, auf dem Gerät aufgestellt werden.

Nederlands

WAARSCHUWINGEN

- Je moet de wisselstroomadapter in de buurt van het stopcontact plaatsen en je moet er gemakkelijk bij kunnen.
- Raak de wisselstroomadapter niet aan met natte handen.
- Bedek de ventilatieopeningen niet met enige voorwerpen, zoals tafelkleden, kranten, gordijnen, enz.
- Plaats geen brandende voorwerpen, zoals kaarsen, op het apparaat.

Español

ADVERTENCIAS

- El adaptador de CA debe instalarse cerca del tomacorriente y debe ser fácilmente accesible.
- No toque el adaptador de CA con las manos húmedas.
- No cubra la ventilación con objetos como manteles, periódicos, cortinas, etc.
- No deben colocarse sobre el equipo elementos con fuego, por ejemplo velas encendidas.

Italiano

AVVERTENZE

- L'adattatore CA deve essere installato vicino alla presa di corrente e deve essere facilmente accessibile.
- Non toccare l'adattatore CA con le mani bagnate.
- Non coprire le fessure di ventilazione con tovaglie, giornali, tende od oggetti analoghi.
- Non posare sull'apparecchio sorgenti di fiamme scoperte quali candele accese.

Svenska

VARNINGAR

- Nätadaptern ska vara installerad i närheten av vägguttaget och vara lätt att nå.
- Hantera inte nätadaptern med våta händer.
- Täck inte för ventilationsöppningarna med några föremål som till exempel bordsdukar, dagstidningar, gardiner e.d.
- Inga föremål med öppen låga, som till exempel tända stearinljus, bör placeras på utrustningen.

ENGLISH**A NOTE ABOUT RECYCLING**

This product's packaging materials are recyclable and can be reused. This product and the accessories packed together are the applicable product to the WEEE directive except batteries. Please dispose of any materials in accordance with your local recycling regulations. When discarding the unit, comply with your local rules or regulations. Batteries should never be thrown away or incinerated but disposed of in accordance with your local regulations concerning chemical wastes.

**FRANÇAIS****REMARQUE CONCERNANT LE RECYCLAGE**

Le matériel d'emballage de cet appareil est recyclable et peut être réutilisé. Cet appareil et les accessoires qui sont emballés avec celui-ci sont conformes, à l'exception des piles, à la directive DEEE (relative aux déchets d'équipements électriques et électroniques). Jetez ce matériel conformément aux réglementations de recyclage locales. Pour mettre l'appareil au rebut, respectez les règles ou réglementations locales. Les piles ne doivent jamais être jetées ou incinérées, mais être mises au rebut conformément aux réglementations locales concernant les déchets chimiques.

**DEUTSCH****RECYCLING-HINWEIS**

Das Verpackungsmaterial dieses Produkts ist für Recycling geeignet und kann wiederverwendet werden. Dieses Produkt und das in seinem Verpackungskarton enthaltene Zubehör mit Ausnahme der Batterien entsprechen der WEEE-Direktive. Bitte beachten Sie bei der Entsorgung irgendwelcher Materialien die örtlichen Recycling-Bestimmungen. Bei der Entsorgung des Gerätes sind die einschlägigen Umweltschutzaufgaben sorgfältig zu befolgen. Batterien dürfen nicht weggeworfen oder verbrannt werden, sondern müssen gemäß den örtlichen Vorschriften zur Entsorgung von chemischem Abfall entsorgt werden.

**NEDERLANDS****RECYCLING VAN APPARATUUR EN VERPAKKINGSMATERIAAL**

De verpakking van dit product is geschikt voor recycling. Dit product en de accessoires, als geheel verpakt, zijn het relevante product volgens de WEEE-richtlijn, behalve de batterijen. Gooi materialen bij het afval volgens de gemeentelijke voorschriften voor recycling. Gooi dit apparaat bij het afval volgens de gemeentelijke wetten of voorschriften. Batterijen mogen nooit bij het normale afval en mogen nooit worden verbrand, maar moeten worden weggegooid volgens de gemeentelijke voorschriften voor chemisch afval.

**ESPAÑOL****NOTA SOBRE EL RECICLADO**

Los materiales de embalaje de este producto son reciclables y pueden ser reutilizados. En este producto y sus accesorios incluidos es aplicable la directiva europea sobre residuos de aparatos eléctricos y electrónicos (RAEE), excepto en lo referente a las pilas. Se ruega eliminar cualquiera de esos materiales de acuerdo con las normas locales de reciclado. Cuando deseches esta unidad, cumple con las normas o reglamentaciones locales. Las pilas no deben tirarse ni incinerarse, sino que deben eliminarse de acuerdo con las normas locales sobre residuos químicos.

**ITALIANO****NOTA SUL RICICLAGGIO**

I materiali di imballaggio di questo prodotto sono riciclabili e possono essere riutilizzati. Questo prodotto e gli accessori in dotazione con esso, eccettuate le batterie, rappresentano il prodotto applicabile per la direttiva RAEE (rifiuti di apparecchiature elettriche ed elettroniche). Smaltirli seguendo le proprie normative locali sul riciclaggio. Quando si desidera eliminare l'apparecchio, attenersi alle indicazioni e alle normative locali. Non gettare via le batterie e non bruciarle, ma smaltirle in conformità alle normative locali relative ai rifiuti chimici.

**PORTUGUÊS****OBSERVAÇÃO SOBRE RECICLAGEM**

Os materiais de embalagem deste produto são recicláveis e podem ser reutilizados. Este produto bem como os acessórios embalados juntos, exceto as pilhas, estão em conformidade com a diretiva WEEE (resíduos de equipamentos elétricos e eletrônicos). Favor descartar os materiais de acordo com as normas e regulamentos locais sobre reciclagem. Obedeça as normas e regulamentos locais quando for descartar o produto. As pilhas não devem ser jogadas no lixo nem incineradas, mas sim descartadas de acordo com as normas e regulamentos locais relativos a resíduos químicos.

**SVENSKA****OM ÅTERVINNING**

Den här produktens förpackningsmaterial är återvinningsbart och kan återanvändas. Den här produkten och de med produkten levererade tillbehören, förutom batterierna, överensstämmer med WEEE-direktivet. Kassera allt material i enlighet med lokala miljöföreskrifter. När enheten ska kasseras ska du följa lokala miljöföreskrifter. Batterier får aldrig slängas i hushållsavfall eller brännas. Dom ska hanteras i enlighet med lokala miljöföreskrifter för kemiskt avfall.



安全上のご注意

絵表示について

この「安全上のご注意」は、製品を安全に正しくお使いいただき、あなたや他の人々への危害や財産への損害を未然に防止するため、いろいろな絵表示をしています。内容をよく理解してから本文をお読みください。



警告

この表示を無視して、誤った取り扱いをすると、人が死亡または重傷を負う可能性が想定される内容を示しています。



注意

この表示を無視して、誤った取り扱いをすると、人が傷害を負う可能性が想定される内容および物的損害のみの発生が想定される内容を示しています。



☞記号は禁止の行為であることを告げるものです。

図の中や近傍に具体的な禁止内容(左図の場合は分解禁止)が描かれています。



●記号は行為を強制したり指示したりする内容を告げるものです。

図の中に具体的な指示内容(左図の場合は電源プラグをコンセントから抜く)が描かれています。



△記号は注意を促す内容があることを告げるものです。

図の中に具体的な注意内容(左図の場合は指をはさまれないように注意)が描かれています。



● 万一、煙が出ている、変なにおいや音がするなどの異常状態のまま使用すると火災・感電の原因となります。すぐにACアダプターをコンセントから抜いてください。煙が出なくなるのを確認して販売店に修理をご依頼ください。



電源プラグを
コンセントから抜く

● 万一、内部に水などが入った場合は、まずACアダプターをコンセントから抜いて販売店にご連絡ください。そのまま使用すると火災・感電の原因となります。

● 万一、機器の内部に異物が入った場合は、まずACアダプターをコンセントから抜いて販売店にご連絡ください。そのまま使用すると火災・感電の原因となります。

● 万一、この機器を落したり、キャビネットを破損した場合は、ACアダプターをコンセントから抜いて販売店にご連絡ください。そのまま使用すると火災・感電の原因となります。



水場での使用禁止

● 風呂場では使用しないでください。火災・感電の原因となります。



警告



● 表示された電源電圧(交流100ボルト)以外の電圧でACアダプターを使用しないでください。火災・感電の原因となります。

● この機器を使用できるのは日本国内のみです。船舶などの直流(DC)電源には接続しないでください。火災の原因となります。

● この機器の上でろうそく等の炎が発生しているものを置かないでください。火災の原因となります。

● この機器の上に花瓶、植木鉢、コップ、化粧品、薬品や水などの入った容器や小さな金属物を置かないでください。こぼれたり、中に入った場合火災・感電の原因となります。



警告



接触禁止

- 雷が鳴り出したら、ACアダプターには触れないでください。感電の原因となります。



- この機器に水が入ったり、ぬらさないようご注意ください。火災・感電の原因となります。雨天、降雪中、海岸、水辺での使用は特にご注意ください。



分解禁止

- この機器の裏ぶた、キャビネット、カバーは絶対外さないでください。内部には電圧の高い部分があり、感電の原因となります。内部の点検・整備・修理は販売店にご依頼ください。
- この機器を改造しないでください。火災・感電の原因となります。



- オーディオ機器を接続する場合は、各々の機器の取扱説明書をよく読み、ACアダプターをコンセントに接続する前に、説明に従って接続してください。また、接続は指定のコードを使用してください。指定以外のコードを使用したり、コードを延長したりすると発熱しやけどの原因となることがあります。
- 製品に同梱しているACアダプターのみ使用してください。製品に同梱していないACアダプターは使用しないでください。火災・感電の原因となります。



電源プラグを
コンセントから抜く

- 旅行などで長期間、この機器をご使用にならないときは安全のため必ずACアダプターをコンセントから抜いてください。
- お手入れの際は安全のためACアダプターをコンセントから抜いて行ってください。
- 移動させる場合は、ACアダプターをコンセントから抜き、機器筒の接続コードなど外部の接続コードを外してから行ってください。ACアダプターが傷つき、火災・感電の原因となることがあります。



注意



- 調理台や加湿器のそばなど油煙や湯気が当たるような場所に置かないでください。火災・感電の原因となることがあります。
- ぐらついた台の上や傾いた所など不安定な場所に置かないでください。落ちたり、倒れたりしてけがの原因となることがあります。
- ACアダプターを熱器具に近づけないでください。コードの被ふくが溶けて、火災・感電の原因となることがあります。
- 窓を閉めきった自動車の中や直射日光が当たる場所など異常に温度が高くなる場所に放置しないでください。キャビネットや部品に悪い影響を与え、火災の原因となることがあります。
- 湿気やほこりの多い場所に置かないでください。火災・感電の原因となることがあります。



- 濡れた手でACアダプターを抜き差ししないでください。感電の原因となります。



- 5年に一度くらいは機器内部の掃除を販売店などにご相談ください。機器の内部にほこりがたまったまま、長い間掃除をしないと火災や故障の原因となることがあります。特に、湿気の多くなる梅雨期の前に行うと、より効果的です。なお、掃除費用については販売店などにご相談ください。

CONTENTS

FEATURES.....	2
PACKAGE CONTENTS.....	2
SUPPORTED iPod	2
PART NAMES	3
UPPER SIDE	3
REAR SIDE.....	3
CONNECTOR PART	4
REMOTE CONTROLLER (RC201IS)	4
OPERATION OF REMOTE CONTROLLER	5
CONNECTION	7
CONNECTING TO OUTLET	7
WALL SETTING	8
PUTTING YOUR iPod IN IS201 DOCK CONNECTOR	9
HOOKING UP THE DOCK CONNECTOR	12
SETTING	14
MODE SETTING	14
VIDEO OUTPUT MODE SWITCH	14
TROUBLESHOOTING.....	15
SPECIFICATIONS.....	15
OTHERS.....	16

FEATURES

With this dock connector, you can connect your iPod with Marantz products or mini system components.

- Easily attach and detach your iPod
- Two types of set-up available (desktop type and on wall type)
- With your iPod docked, you can control your iPod with the supplied remote controller
- Play the stereo sound on your iPod with the dock connector's AUDIO OUT L/R jacks connected to your audio amp
- You can watch the play list, artist names, song titles, image data, photo data and slideshows stored on your iPod on a TV connected to the dock connector
- Charge your iPod battery

PACKAGE CONTENTS

Make sure you have the following items:

- IS201 Dock Connector 1 pce
- RC201IS Remote Controller 1 pce
- AC adapter 1 pce
- AC plug adapters (3 types)
 - for UK 1 pce
 - for Europe 1 pce
 - for U.S.A./Japan 1 pce
- iPod adapters
 - Type A (attached to the dock connector with shipment) 1 pce
 - Type B 1 pce
 - Type C 1 pce
 - Type D 1 pce
- S-Video cable 1 pce
- RCA audio pin cable 1 pce
- Remote cable 1 pce
- Wall setting screws 2 pcs
- Instruction manual 1 pce
- Warranties
 - For Japan 1 pce
 - For Canada 1 pce
 - For U.S.A. 1 pce
- Registration card for Europe 1 pce

SUPPORTED iPod

- iPod Video (5th Generation)
- iPod nano
- iPod (U2 Edition)
- iPod mini
- iPod Photo (4th Generation)
- 4th Generation iPod with Click Wheel
- 3rd Generation iPod with Touch Wheel

Note

- Before using the dock connector, update your iPod with the latest software, available from the Apple Website.

PART NAMES

UPPER SIDE

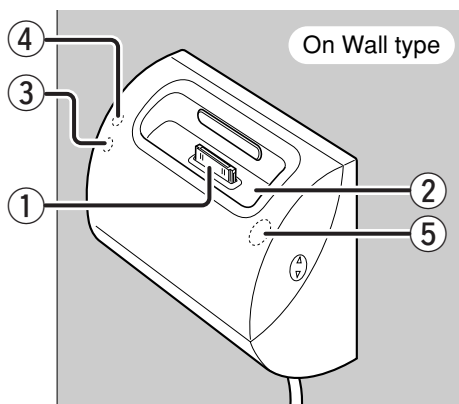
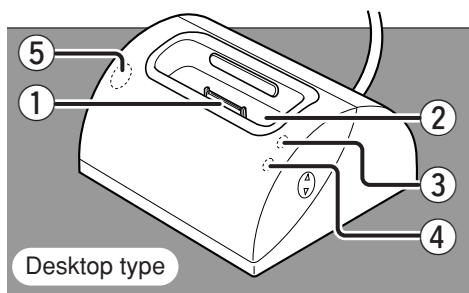

① Dock connector

Connects to your iPod's dock connector.

② iPod slot

Insert the appropriate type of adapter to put your iPod.

- Be sure to use the appropriate adapter (p.9)

③ Red indicator

Lights up when connected to AC power source and blinks when receiving IR signal from the remote controller.

④ Blue indicator

Lights up when the dock connector is connected to your iPod.

⑤ Remote IR Receiver

When using this IR receiver make sure this area is unobstructed.

REAR SIDE

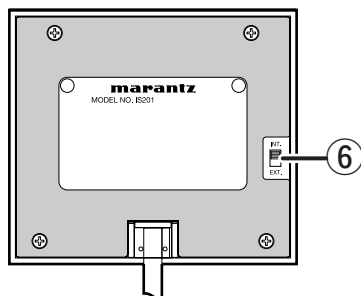

⑥ Remote control INT./EXT. switch

Remote control switching. See page 13 for more information.

- Set it to INT. when remote control cable is not connected.

CONNECTOR PART

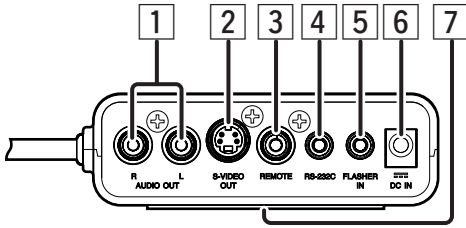

1 AUDIO OUT L/R jacks

Connect to your AV amp's/receiver's audio input jack.

2 S-VIDEO OUT jack

Connect to your AV amp's/TV monitor's video input jack.

3 REMOTE jack

Connect to your Marantz product with remote control jack (RC-5).

4 RS-232C jack

Used to connect to an external control system.

5 FLASHER IN jack

Used to control equipment with key pad, etc.

6 AC adapter connect jack

Connect the supplied AC adapter.

7 Magnet rubber

Attach the connector part temporarily on metallic surface of wall, etc.

Be careful fixation may not be secured enough depending on the condition of attached surface.

REMOTE CONTROLLER (RC201IS)

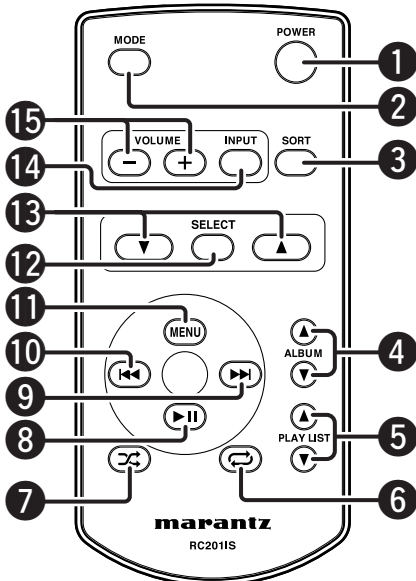

1 POWER button

Turns power on and off your iPod.

2 MODE button

Switches IS201's mode setting (OSD/LCD). (p.14)

3 SORT button (in OSD mode only)

Sorting of Song/Artist/Album stored on your iPod in sequence, not operative in LCD mode.

4 ALBUM ▲ ▼ button (in LCD mode only)

Selects the next and previous album on the iPod.

5 PLAY LIST ▲ ▼ button (in LCD mode only)

Selects the next and previous play list on the iPod.

6 REPEAT button

Sets the iPod's Repeat function to: One, All, Off.

7 SHUFFLE button

Sets the iPod's Shuffle function to: Songs, Albums, Off.

8 ►|| (PLAY/PAUSE) button

Same function as iPod's click wheel ►||.

9 ►►| (SKIP) button

Presses the button once to select the next contents.

10 ◀◀| (BACK SKIP) button

Presses the button once to restart the current iPod contents, press it twice in a row to select the previous contents.

11 MENU button

Same functions as the iPod's click wheel menu.

12 SELECT button

Same functions as the iPod's click wheel select button.

13 ▲▼ button

Same functions as the iPod's click wheel counterclockwise(▲) and clockwise (▼).
• Except for the iPod's volume control.

14 INPUT button

Switches the input of connected your Marantz amp/receiver (some models are not operative).

15 VOLUME +-button

Please to adjust the volume control of your marantz amplifier / AV receiver.

OPERATION OF REMOTE CONTROLLER

Please make sure the below instructions are followed when operating your remote controller.

- Do not spill water or any other liquid on your remote controller.
- Do not drop, apply excessive impact on your remote controller.
- Do not leave your remote controller in a place such as;
 - At high humidity/temperature (near heater, bathroom)
 - At extremely low temperature
 - Dusty

■ Before using your remote controller

Note that your remote controller is provided with lithium battery and can be operative after removing insulation sheet.

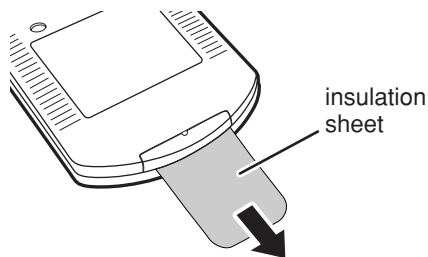

■ Handling battery

Improper handling of lithium battery may cause heat generation, ignition or bursting, so be sure to follow the below instructions when handling the lithium battery.

- The supplied battery is provided to check the functionality of your remote controller.
- Use only battery type CR2025.
- Do not recharge your battery.
- Do not handle roughly or disassemble your battery.
- When you replace your battery, be sure to insert the battery with polarity (+)(-) correctly.
- Do not place your battery in any place where it will be subjected to direct sunlight or high temperature.
- Keep your battery out of the reach of children. In case of accidental ingestion, immediately consult a doctor.
- Leaky battery should be disposed immediately. If the liquid is spilt on your skin or cloth, you can get a skin burn, so be sure to handle leaky battery carefully. When the solution adheres to the skin and/or clothes, wash it with water and consult a doctor.
- At disposal of used batteries, insulate terminal parts by winding with tape. Dispose the battery away from fire in accordance with applicable local regulations.

■ Battery replacement

If you find that the remote control must be used closer to the main unit than usual, the battery is weak. Replace the battery new one.

1. Slide out the battery holder from the remote control by pushing into the hole in the holder with a ball-point pen ,etc.
 2. Replace the battery from the battery holder, and then place new one in the holder, positive side upward.
 3. Slide the holder into the remote control.
- a ball-point pen ,etc.

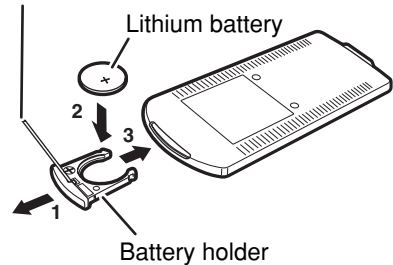

■ Remote-controllable range

The distance between the transmitter of the remote control and the IR SENSOR of the IS201 should be less than 5 meters. If the remote control is pointed in a direction other than the IR SENSOR or if there is an obstacle between them, use of the remote control may not be possible.

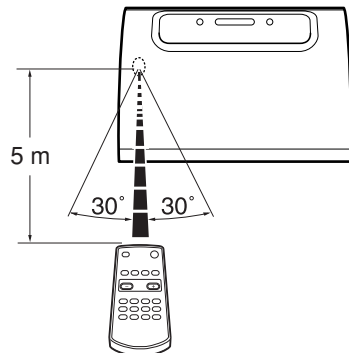

CONNECTION

CONNECTING TO OUTLET

1. Fit the appropriate AC plug adapter to the AC adaptor as shown below.

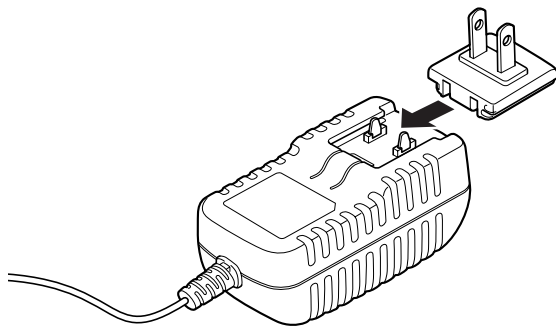

2. Connect the AC adaptor to the IS201's DC IN jack.
3. Plug the AC adaptor into a suitable wall outlet.

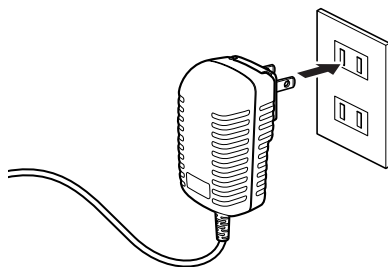
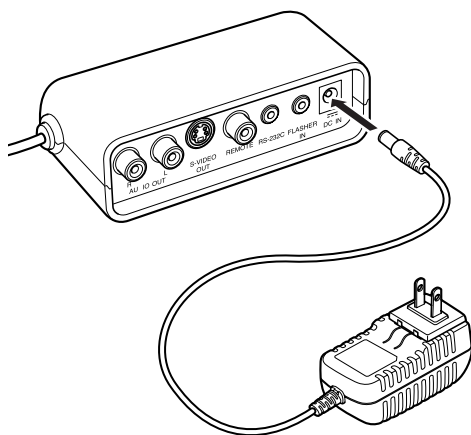

WALL SETTING

- Please note that supplied wall setting screws are used for wooden wall.
- Make sure that screws are firmly secured to the wall (poll).
- Make sure that there is no electric wiring or piping inside the wall.

Note

- Do not mount the dock connector on plaster board, ALC (autoclaved lightweight concrete), concrete block or plywood less than 10mm thick as the intensity is insufficient (If the dock connector falls from the wall, it may cause an injury).

1. Disconnect the adapter.

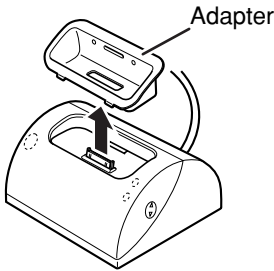

2. Remove the cover.

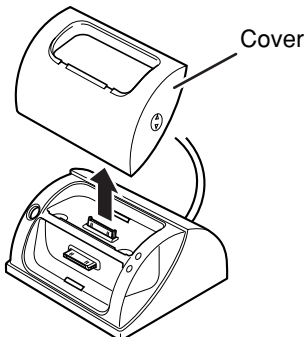

3. Install the supplied screws in the dock connector and fasten it on the wall.

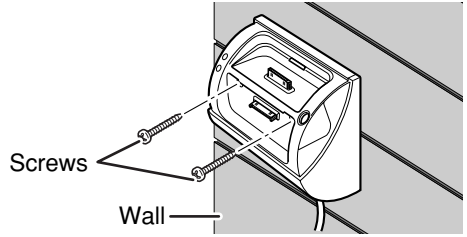

4. Attach the cover.

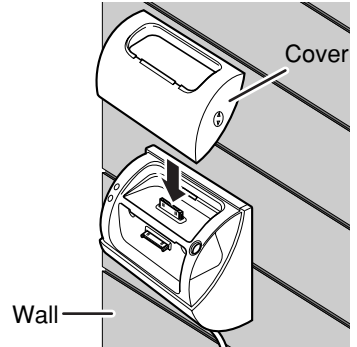

5. Connect the adapter

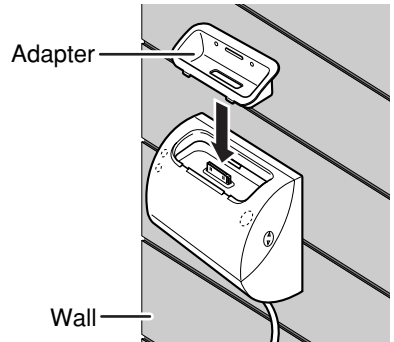

Notes

- Be sure that the cover is attached or removed in the direction of arrow shown on the side.
- Do not leave the cover and adapter removed while using the dock connector as it may cause a malfunction.

PUTTING YOUR iPod IN IS201 DOCK CONNECTOR

1. Make sure that IS201 Dock Connector is plugged into a wall outlet.
2. Depending on the type of iPod, insert the applicable iPod adapter into the dock connector slot, as shown below.
 - There are four types of iPod adapters; Types A, B, C & D. Be sure to insert one of the supplied iPod adapters.
 - Do not insert wrong iPod adapter as it may cause a malfunction.

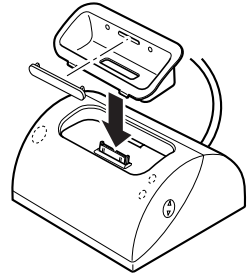

(In case of type B+D)

■ iPod Adapters (“A”, “B”, “C” are indicated on the rear side)

• Type A

(inserted in the dock connector with shipment)

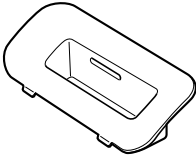

• Type B

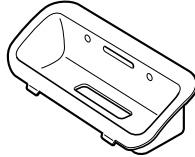

• Type C

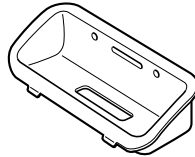

• Type D



■ iPods & their supporting iPod Adapters:

● iPod Video (5th Generation)

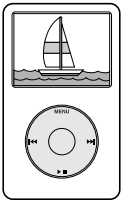

30GB

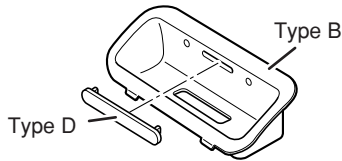

Type B+D

60GB

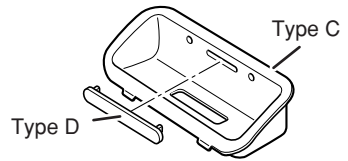

Type C+D

● iPod nano

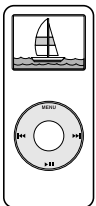

1GB / 2GB / 4GB

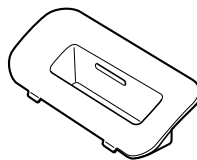

Type A

● iPod (U2 Edition)

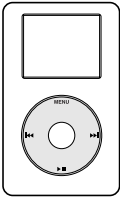

20GB

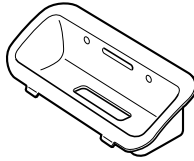

Type B

60GB

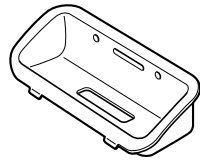

Type C

● iPod mini

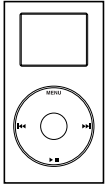

4GB / New 4GB / 6GB

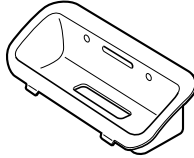

Type B

● iPod Photo (4th Generation)

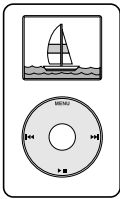

30GB

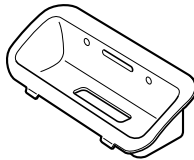

Type B

40GB / 60GB

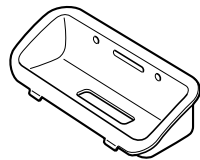

Type C

● iPod (4th Generation)

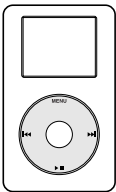

20GB

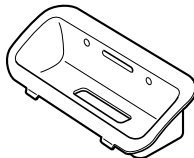

Type B

40GB

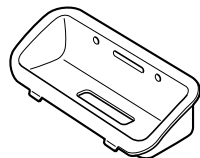

Type C

● iPod (3rd Generation)

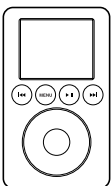

10GB / 15GB / 20GB

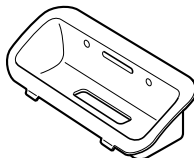

Type B

30GB / 40GB

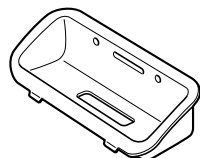

Type C

3. Fit your iPod dock connector port securely onto the dock connector.

When you insert your iPod, the dock connector's blue power indicator will light up.

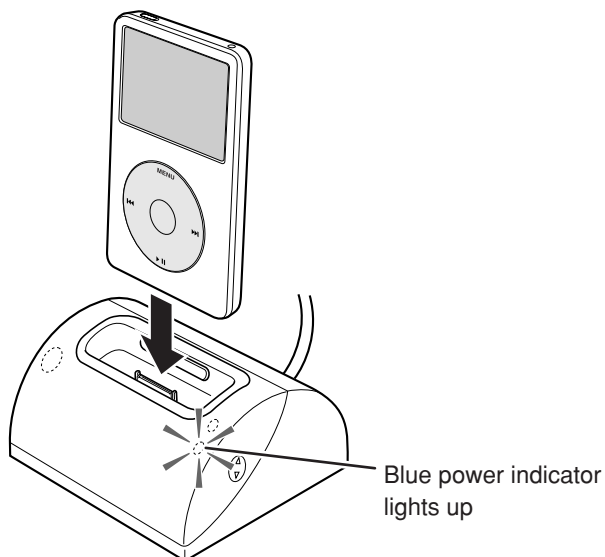

Notes

- Marantz bears no responsibility whatsoever for any loss or damage to data on your iPod that may occur when the iPod is used connected to the dock connector.
- Be sure to use the correct adapter for your type of iPod. If the wrong adapter is used, it may not operate correctly even if the blue power indicator lights up.
- If your iPod is inserted into the IS201 with the power off, or if you plugged the AC adapter into a wall outlet with your iPod inserted in the IS201, it may take some time for your iPod power to switch on and become operable.
- To prevent dock connector damage, don't twist your iPod when inserting or removing it.
- Be careful not to knock over the iPod when inserted to prevent dock connector damage.
- Don't use with any other iPod accessories, such as FM transmitters and microphones, because they may cause a malfunction.

HOOKING UP THE DOCK CONNECTOR

■ Connecting to AV receiver

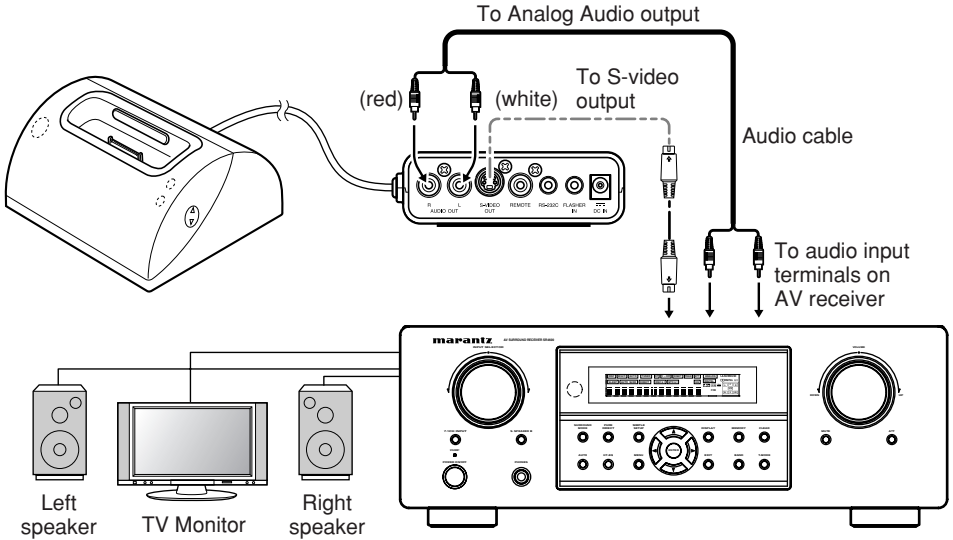

■ Connecting to Amp, Monitor

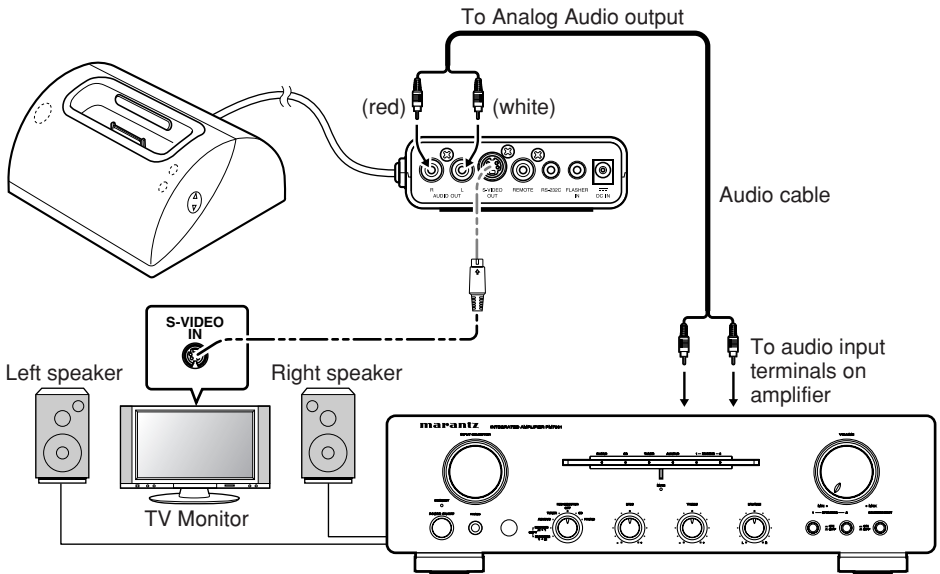

■ Connecting to Marantz product's remote control jack (RC-5)

- When the dock connector is used without connecting any other Marantz product's remote control jack, set the switch to "INT".
- By connecting the dock connector's remote jack to the remote jack on other Marantz product, the dock connector can act as a remote control signal receiver for the other Marantz product. In order to do this, set the dock connector's switch to "INT.", and set the remote jack on the connected Marantz product to "EXT."

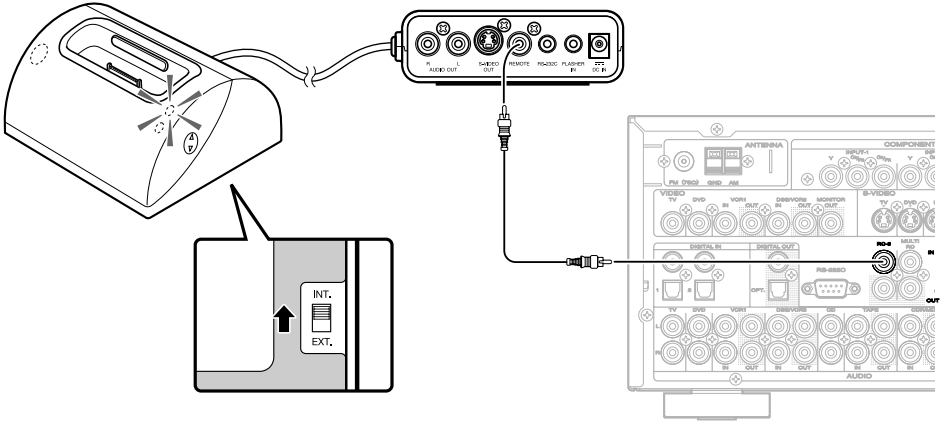

- If IR remote of other Marantz product is used instead of the dock connector's remote, set the switch to "EXT." dock connector.

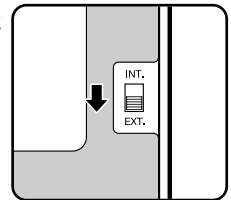

SETTING

MODE SETTING

You can operate your iPod with this dock connector in two modes, OSD mode and LCD mode, and mode selection can be available by pressing MODE button.

Note

- Note that in case of removing AC adapter or blackout occurrence after mode setting, the dock connector is set to OSD mode(default setting).

■ OSD Mode (On Screen Display Mode)

Only remote controller can control your iPod. "marantz" is shown on your iPod's display. The connected TV's screen shows the Control Menu to control your iPod.

Notes

- Depending on the type of iPod, some settings are not supported. In this case, please update your iPod to the latest firmware.
- The Control Menu supports only English. If the set language is non-English, "#" may be displayed on the screen.
- The LCD mode is used to playback video contents or photograph data.
- Leaving the iPod's Control Menu displayed on an LCD or plasma TV for a long period of time may result in afterimages on the screen. To prevent that, press the remote controller's ALBUM ▲ button for two seconds or more to turn off the OSD menu when it does not need to be displayed. The menu will display again when PLAY/PAUSE or other operation buttons are pressed.

■ LCD Mode

- Operation can be available by both your iPod and the remote controller.
- Your iPod's LCD (liquid crystal) displays normally.
- The iPod's Control Menu is not displayed on the connected TV screen.

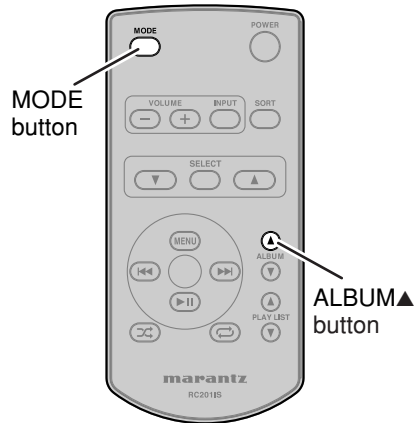

VIDEO OUTPUT MODE SWITCH

Press MODE button for more than three seconds, then control display's output mode is switched to PAL/NTSC. The default mode is set to NTSC.

Notes

- Note that in case of removing AC adapter or blackout occurrence after video mode setting, it is set to NTSC mode(default setting).
- Set your iPod's TV signal and TV out on your iPod.

TROUBLESHOOTING

■ There's no sound

Check your IS201 dock connector.

- Make sure the iPod is inserted properly in the dock connector.
- Make sure your iPod is playing.
- Make sure the cable plugs are pushed in all the way.
- Make sure the AC adapter is connected to a suitable wall outlet and connected to IS201 dock connector.

Check the receiver or amp connected to IS201 dock connector.

- Make sure the power is turned on.
- Make sure the input is selected on the jack connected to your iPod.
- Make sure the volume control is not set too low.

■ The remote controller doesn't control the iPod

Check your IS201 dock connector

- Make sure the iPod is inserted properly in the dock connector.
- Make sure there is nothing to block the infrared radiation between IS201 dock connector and remote controller.
- Make sure you've selected the right mode for the remote mode switch on the rear of IS201 dock connector.
- Make sure the remote control cable is connected properly.

■ There's no control display on TV screen

Make sure the display mode (OSD/LCD) is set properly, or the selected mode is suitable for the TV type. (p. 14)

SPECIFICATIONS

Power Supply	DC IN12V (AC ADAPTER)
Net weight (DOCK PART, CONNECTOR PART, including mains cord)	350g
Dimensions	DOCK PART: 95 × 49 × 84mm
.....	CONNECTOR PART: 102 × 34 × 54mm
Terminals	S-video output × 1, Analog Audio output × 1, Remote output × 1, RS232C terminal × 1, FLASHER IN terminal × 1

● AC Adapter (Supplied)

Power Supply	AC100V – 240V (50Hz / 60Hz) 0.4A
--------------------	----------------------------------

Specifications subject to change without prior notice.

OTHERS

The section describes the care and maintenance tasks that must be performed to optimize the operation of your Marantz equipment.

■ Cleaning of equipment external surfaces

The exterior finish of your unit will last indefinitely with proper care and cleaning. Never use scouring pads, steel wool, scouring powders or harsh chemical agents (e.g., lye solution), alcohol, thinner, benzine, insecticide or other volatile substances as these will mar the finish of the equipment. Likewise, never use cloths containing chemical substances. If the equipment gets dirty, wipe the external surfaces with a soft, lint-free cloth.

If the equipment becomes heavily soiled:

- dilute some washing up liquid in water, in a ratio of one part detergent to six parts water.
- dip a soft, lint-free cloth in the solution and wring the cloth till it is damp.
- wipe the equipment with the damp cloth.
- dry the equipment by wiping it with a dry cloth.

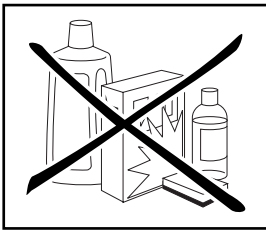

■ Repairs

Only the most competent and qualified service technicians should be allowed to service the factory-trained warranty station personnel have the knowledge and special facilities needed for repair and calibration of this precision equipment. After the warranty period has expired, repairs will be performed for a charge if the equipment can be returned to normal operation.

In the event of difficulty, refer to your dealer or write directly to the nearest location to you that is listed on the Marantz Authorized Service Station list. If writing, please include the model and serial number of the equipment together with a full description of what you think is abnormal about the equipment's behaviour.

DIMENSIONS

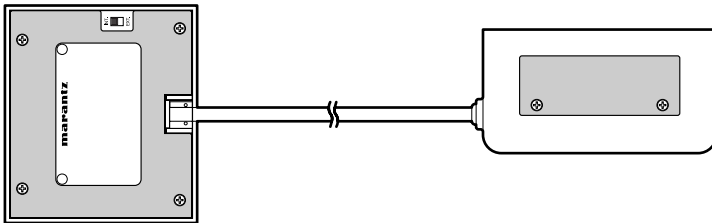
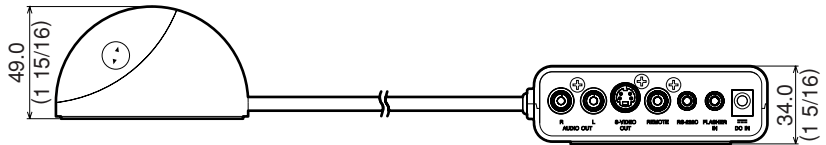
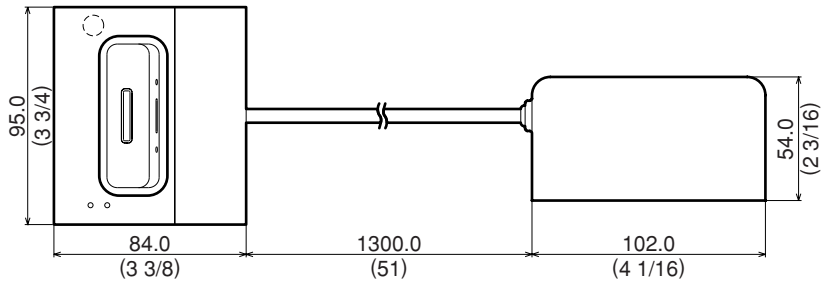

Unit: mm (inch)

www.marantz.com

You can find your nearest authorized distributor or dealer on our website.

U.S.A.	Marantz America, Inc.	100 Corporate Drive, Mahwah, NJ, 07430, U.S.A.
EUROPE	Marantz Europe B.V.	P.O. Box 8744, 5605 LS Eindhoven, The Netherlands

marantz® is a registered trademark.