

marantz®

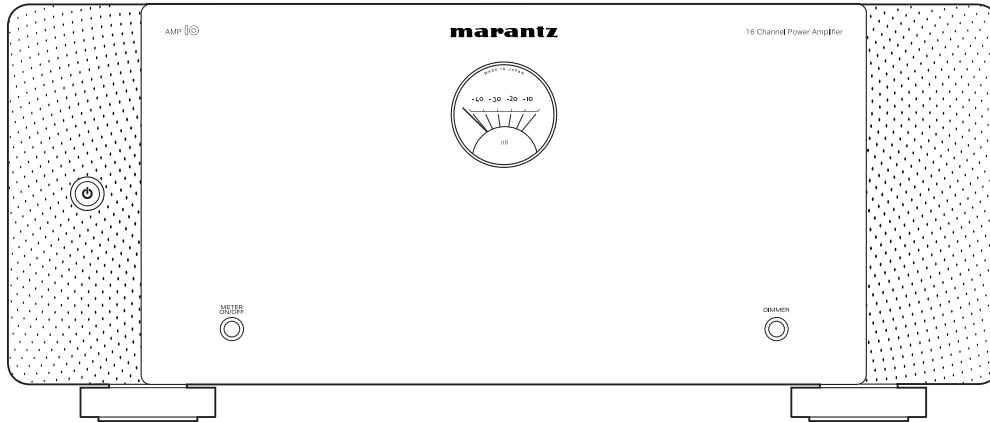

AMP  | Power Amplifier

QUICK START GUIDE

Welcome

Thank you for choosing a Marantz power amplifier.

Connecting a Marantz AV 10 and speakers (sold separately) to this unit enables use of a variety of surround sound systems.

This guide describes how to connect AV Preamplifier and speakers to this unit.

Please do not return this unit to the store – call for assistance.

If you need help... :

If you need additional help in solving problems, contact Marantz customer service in your area.

www.marantz.com

Before you begin

Required for setup

RCA cables



or

XLR cables



AV Preampifier

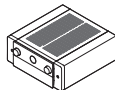

Speakers

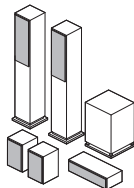

Speaker cables



What's in the box

Quick start guide

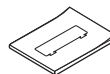

Safety instructions



Power amplifier

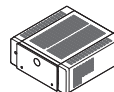

Power cord



REMOTE CONTROL
connector cable



AMP CONTROL
connector cable



Speaker terminal wrench



Setup

1 Connect your speakers

There are 3 modes for connecting this unit with speakers:

- Normal mode
- Bi-amp mode
- BTL mode (Bridge mode)

Set the NORMAL/BI-AMP/BTL selector on the rear panel of this unit according to the connection mode used.

NOTE

Always set the NORMAL/BI-AMP/BTL selector before turning on the power. If the setting is changed after turning on the power, the setting will not be applied.

■ Normal mode

Connect your speaker cables between the AMP 10 and your speakers. This is the default setup, where you simply connect the speakers directly to the corresponding pair of terminals.

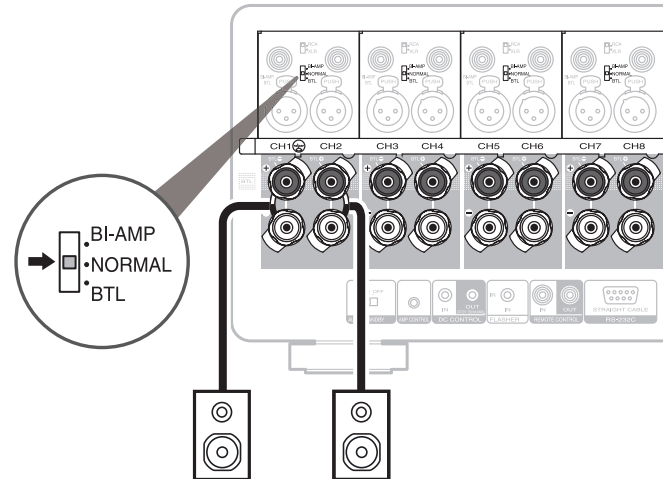

■ Bi-amp mode

Connecting separate amplifiers to the tweeter terminal and woofer terminal of a speaker that supports bi-amplification enables playback with higher sound quality.

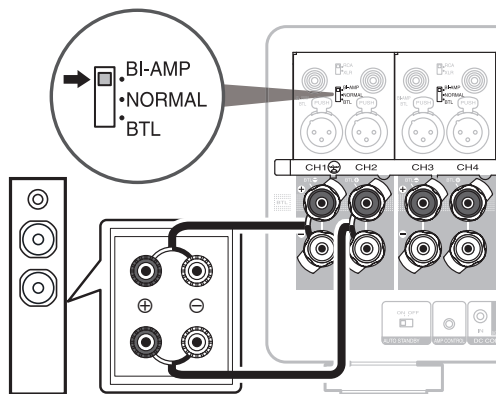

- When making bi-amp mode, be sure to remove the short-circuiting plate or wire between the speaker's woofer and tweeter terminals.

■ BTL mode (Bridge mode)

Using 2 amplifiers to drive 1 speaker enables more powerful playback.

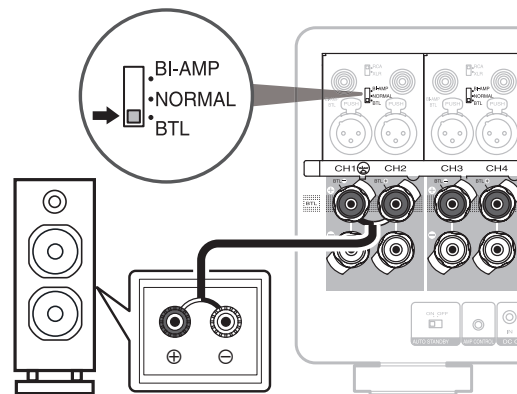

- For the highest power set-up, the BTL mode can convert the 2 x 200 W at 8 ohms stereo amplifier to a 400 W mono amplifier. The two-amplifier circuit construction guarantees an excellent signal to noise ratio and the full control of any speaker.

How to use the speaker terminal wrench

Use the included speaker terminal wrench to easily loosen or tighten the speaker terminals.

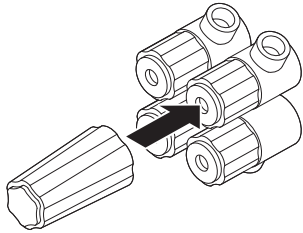

Loosening

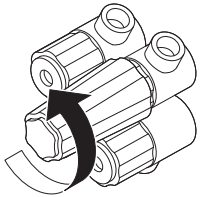

Tightening

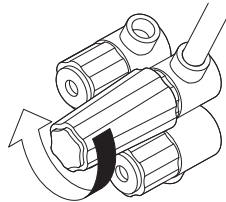

- The speaker terminal wrench contains a built-in magnet that enables it to be attached to the rear panel. After connecting speakers, store it in the included accessory box or in another safe place.

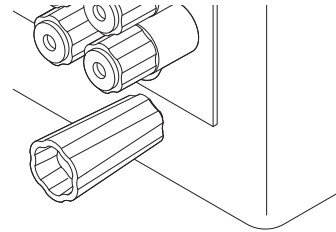

2 Connect your AV Preamplifier

There are 2 methods for connecting this unit with an AV Preamplifier... an unbalanced connection or a balanced connection. Set the RCA/XLR INPUT selector on the rear panel of this unit according to the connection method used.

NOTE

Always set the RCA/XLR INPUT selector before turning on the power. If the setting is changed after turning on the power, the setting will not be applied.

■ Connect the UNBALANCED RCA INPUT connector

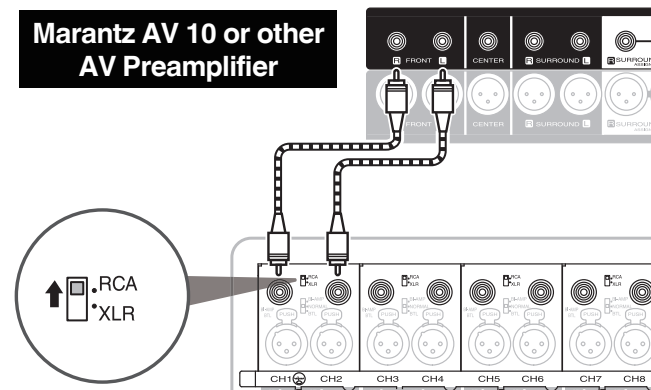

■ Connect the BALANCED XLR INPUT connector

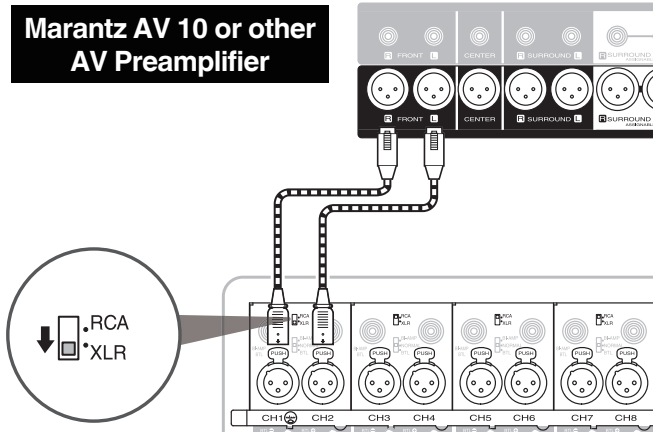

NOTE

When connecting speakers using a bi-amp connection or BTL connection, connect BALANCED XLR or UNBALANCED RCA to an odd-numbered channel (CH1, CH3, CH5, CH7...). Do not connect to an even-numbered channel (CH2, CH4, CH6, CH8...).

Marantz AV 10 or other AV Preamplifier

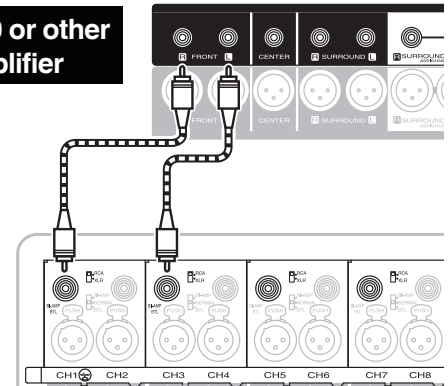

3 Connect the power cord

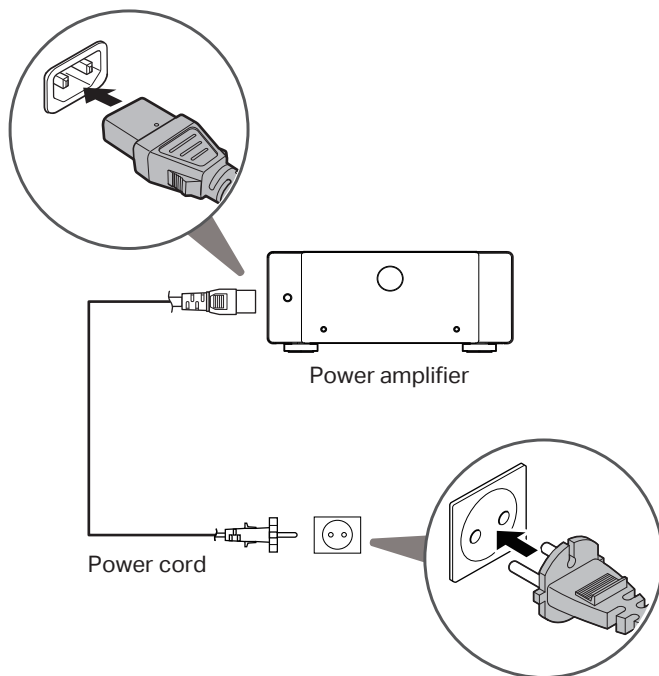

4 Turn on the power amplifier

Press the  button on the power amplifier.

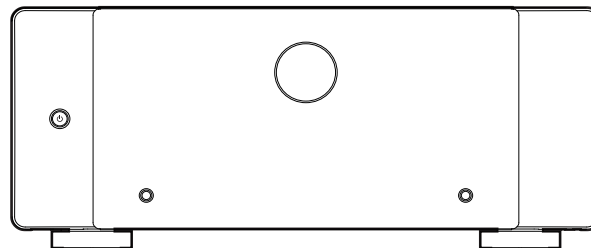

Owner's manual

Control cables (included)

The AMP 10 comes with the following two types of control cables. Choose between the two to suit the type of device you are connecting.

AMP CONTROL connector cable

When the AMP 10 is connected to a Marantz AV Preamplifier with an AMP CONTROL terminal, the following linked operations can be performed.

- When the AV Preamplifier is turned on or put on standby, the same operation is applied to the AMP 10.
- When the display brightness setting of the AV Preamplifier is changed, the new setting is also applied to the front panel lights of the AMP 10.

REMOTE CONTROL connector cable

When the AMP 10 is connected to a Marantz product with a REMOTE CONTROL terminal, the following linked operations can be performed.

- When a Marantz product is turned on or put on standby, the same operation is applied to the AMP 10.

Refer to the owner's manual for details such as instructions on connecting.

Refer to the online manual for other functions, information, and operation procedure details.

manuals.marantz.com/AMP10/EU/EN/



Online manual

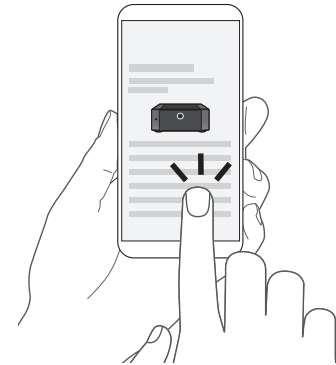

For more information, visit www.marantz.com



marantz®