



marantz®

Model DR6000 User Guide

Compact Disc Recorder





INTRODUCTION

Congratulations on the acquisition of your CD-Recorder. This CD-Recorder now enables you to record, play and erase your own audio Compact Discs. Naturally the recorder can also be used to play all pre-recorded CDs.

With the exception of legal restrictions pertaining to copying, you can now create your own high-quality audio recordings on CD. The discs used to record must bear the logos shown below. Copyright fees have been paid on these discs in some countries. Recording on other types of discs (e.g. CD-R for professional recordings) is not possible.

There are two types of recordable AUDIO discs:
CD-R(W) discs have a compatibility to play/record on the CD-Recorders based on the ORENGE BOOK Part II/III. But the discs might not be able to be played/recorded properly depending on the combinations of the discs and CD-Recorders.

1 CD Recordable Audio (record once):

Fully recorded and subsequently finalized audio CD-R discs can be played on CD players and recorders that are suitable for CD-R discs. A CD-R disc can be recognized by the following logo:



2 CD ReWritable Audio (multiple recording):

Recorded and finalized audio CD-RW discs can be played on CD players and recorders that are suitable for CD-RW discs. An increasing number of players and recorders will be suitable for these discs in the future. A CD-RW disc can be recognized by the following logo:



The CD-R(W) disc for 'DIGITAL AUDIO' can be both recording and playing on this CD-Recorder. In addition, this CD-Recorder can play the CD-R(W) disc for 'PROFESSIONAL RECORDING', but cannot record it.

Once you start using the recorder, you will discover how easy it is to 'make' your own CDs. Nevertheless, we recommend that you use an erasable (CD-RW) digital audio disc on your first attempt, while following the instructions given here.

Attention!

Recordings may only be made for personal use.

It is forbidden to copy material protected by copyright, including computer programs, films, television and audio recordings. This appliance may not be used for applications of this type.

Note:

Some CD players can not play the finalized CD-R(W) discs because of the low reflectivity of such discs.

Because of laser power differences, some DVD players cannot play the finalized CD-R(W) discs.

Read the text carefully and keep the instructions close at hand so that you can refer to them if necessary.

Unpacking

First check the contents of the packaging. It should contain the following:

- CD-Recorder DR6000
- Remote control with batteries packaged separately
- Audio cables (2 - with red and white plugs) × 2
- Digital coax cable (with black plugs) × 1
- Remote control cable (with orange plugs) × 1
- Instructions
- Guarantee

If one of these components is missing, please inform your supplier immediately. Save the packaging material it may come in handy if you move the appliance.

Setup

- Place the recorder on a strong, vibration-free surface.
- Do not use the recorder under extremely damp conditions.
- If the recorder is placed in a cabinet, make sure that a 2.5 cm space remains free on all sides of the recorder for proper ventilation.

Attention!

If the appliance is not used or operated in accordance with the instructions, this may result in exposure to dangerous radiation or other risks.

Only authorized technicians are allowed to open the appliance casing or to perform repairs or maintenance.

Compact discs

The glossy side shining like a rainbow is the front side of the disc, and the side on which the label is printed is the back. Unlike conventional turntables for playing analog discs, the DR6000 reads the information recorded on the disc from underneath without contacting it using a beam of laser light. Therefore, the performance of a compact disc will not degrade like conventional analog records.

Handle discs carefully so as not to damage or scratch the front side.

To protect the disc, avoid placing it in the following locations:

- In direct sunlight or near a source of heat like a heater.
- In a place which is damp or dirty.
- In a place which could be exposed to rain, such as near a window.

Always keep the disc surface clean.

Up to six billion data units are recorded on the front side of the disc. When cleaning the disc surface, always be sure to use a special compact disc cleaner and wipe as shown below.

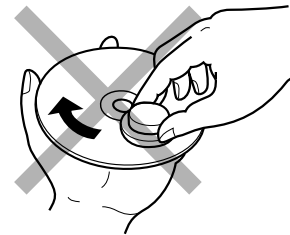
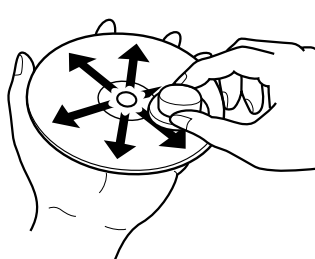

Wipe in a radial direction. Do not wipe in circumferential direction.

INTRODUCTION

- Do not use conventional record cleaner for analog records, as this will adversely affect the disc surface. Store discs properly by placing them in their disc cases.
- Do not attach a piece of paper or sticker on the label side of disc. When a disc has a piece of plastic tape or rental CD label with paste protruded from the edge or when a disc has a trace of such a sticky object, do not attempt to play the disc. If such a disc is played on the CD player, impossibility of taking out the disc or other malfunction may result.

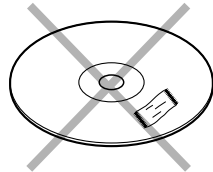

- Write only on the printed side of a CD-R or CD-RW, and only with a soft felt-tipped pen.
- Do not use a disc with a special shape. Do not attempt to play a disc with a special shape such as a heart-shaped disc or octagonal disc. Otherwise the equipment malfunction may result.

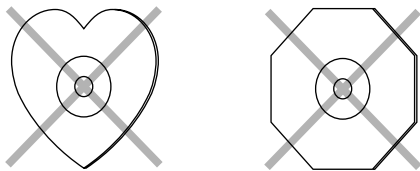

Maintenance

Clean the CD-Recorder with a soft, slightly dampened lint-free cloth. Do not use any cleaning agents as they may have a corrosive effect.



Do not expose the CD-Recorder, batteries or CDs to humidity, rain, sand or excessive heat (caused by heating equipment or direct sunlight).

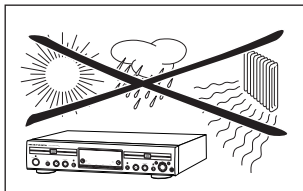

If the CD-Recorder cannot read CDs correctly use a commonly available cleaning CD to clean the lens before taking the CD player to be repaired. Other cleaning methods may destroy the lens. Always keep the tray closed to avoid dust on the lens.

The lenses may cloud over when the CD-Recorder is suddenly moved from cold to warm surroundings. It is not possible to play a CD then. Leave the CD-Recorder in a warm environment until the moisture evaporates.

CONTROLS AND CONNECTIONS

Controls on the front

CD-Recorder

- (1) **POWER ON/OFF** turns the CD-Recorder ON and OFF
- (2) **Standby indicator**
- (3) **Disc tray** records CD-R(W) and plays CD and CD-R(W)
- (4) **DISPLAY** selects display information/text
- (5) **SCROLL** activate scrolling of text over the display (once)
- (6) **▲ OPEN/CLOSE** opens/closes disc tray
- (7) **SOURCE** selects external input source
- (8) **ERASE** selects erasing mode
- (9) **STORE/MENU** - enters Menu mode
- stores Menu settings
- (10) **CANCEL/DELETE** - deletes tracks from a program
- deletes text in Menu mode
- returns to a higher level in the menu
- (11) **FINALIZE** selects finalize mode General
- (12) **- EASY JOG +** - previous/next track (Play and Program mode)
- recording level control (recording)
- selects settings (menu on)
- PUSH/ENTER** - plays selected tracks
(push) - selects settings in Menu mode
- programs track numbers
- (13) **● REC (ord)** starts recording, finalizing, erasing
- (14) **LEVEL** adjust the headphone volume
- (15) **PHONES** socket for headphones
- (16) **▶/II PLAY/PAUSE** starts play/interrupts play or recording
- (17) **■ STOP** stops/clears a program
- (18) **▶▶** - searches forward
- cursor control in Menu/Prog. review mode
- (19) **◀◀** - searches backward
- cursor control in Menu/Prog. review mode
- (20) **REC (ord) TYPE** selects recording modes
- (21) **Display** information screen

Note:

- When provided on the remote control, you can also use the corresponding buttons.
- Some buttons are only on the remote control.

Connections at the back

- (22) **ANALOG INPUT** connects to the line output of an amplifier (left and right)
- (23) **ANALOG OUTPUT** connects to the line input of an amplifier (left and right)
- (24) **DIGITAL INPUT** connects to the digital coaxial output of an external CD player
- (25) **DIGITAL OUTPUT** connects to the digital coaxial input of e.g. amplifier or recording device
- (26) **OPTICAL INPUT** connects to the digital optical output of an external CD player
- (27) **OPTICAL OUTPUT** connects to the digital optical input of e.g. amplifier or recording device
- (28) **REMOTE CONTROL OUT** connects to a remote control input on the Marantz amplifier
- (29) **REMOTE CONTROL IN** connects to a remote control output on the Marantz amplifier
- (30) **REMOTE CONTROL SWITCH**
- (31) **AC POWER CABLE**

DISPLAY indications

- (32) **REM/REC TIME** remaining recording time / recording time
- (33) **TRACK** track number
- (34) **▬** balance (lights during balance adjustment)
- (35) **TOTAL REM TRACK TIME** total or remaining time of disc or track
- (36) **STEP** indicates the number of tracks in a program
- (37) **20 +** disc or program contains more than 20 tracks
- (38) **Track Number** tracks on a discs or in a program track in play
- (39) **PROGRAM** flashes during programming/ lights in program mode
- (40) **RANDOM ALL** plays tracks in random order
- (41) **SCAN** lights up when the first 10 seconds of each track are played.
- (42) **REPEAT TRACK/ALL** ... lights up when a track/ complete disc (or program) is repeated.
- (43) **L/R** record/play level bar. Indicates the audio signal level.
- (44) **▶** lights during play
- (45) **R (W)** unfinalized CD-R(W) disc inserted
- (46) **●** lights during recording
- (47) **II** pause function active
- (48) **OPT I** → optical input I selected for external recording
- (49) **ANALOG** → analog input selected for external recording
ANALOG analog recording
- (50) **MANUAL** manual start of external recording
- (51) **SYNC** automatic or synchronized start of external recording
- (52) **DIG I** → digital input I selected for external recording

REMOTE CONTROL

Remote control commands

- (53) **STANDBY**  switches to Standby On/Off
- (54) **TRACK INCR. (ement)** .. increases track numbers during recording
- (55) **SCAN** plays the first 10 seconds of each track
- (56) **REPEAT** repeat play(All, program or track)
- (57) **Number/alphabet keys 0 - 9** .. - selects a track by number
- selects character for text input
- (58) **DISPLAY** selects display information/text
- (59) **CDR** selects CD-Recorder
- (60) **▶** starts CD-R(W) play
- (61) **◀◀** previous track (Play and Program mode)
- (62) **◀◀** - searches backward
- cursor control in Menu/Prog. review mode
- (63) **||** interrupts CD-R(W) play/recording
- (64) **MENU/STORE** - enters Menu mode
- stores Menu settings
- (65) **ENTER** - selects settings in Menu mode
- programs track numbers
- starts playback of selected track
- (66) **CANCEL/DELETE** - deletes tracks from a program
- deletes text in Menu mode
- returns to a higher level in the menu
- (67) **▶▶** - searches forward
- cursor control in Menu/Prog. review mode
- (68) **■** stops CD-R(W) and clears a program
- (69) **▶▶|** next track (Play and Program mode)
- (70) **CD** selects CD player
- (71) **SCROLL** activates scrolling of text over the display
- (72) **PROG. (ram)** opens/closes program memory
- (73) **RANDOM** plays CD-R(W) or program in random order

INSTALLATION

This CD-Recorder can be used to record directly or through a (pre-) amplifier from any digital or analog audio source. In addition, the appliance can be used as a regular CD player. Read how to connect the CD-Recorder based on the possibilities your other audio equipment offers. Please refer to the operating instructions for your other audio equipment first.

The following options are available:

- analog connections
- digital coaxial connections
- digital optical connections

Analog connections

For recording and playing, connect the CD-Recorder to an amplifier (preferably the CD-Recorder or TAPE connection) based on the diagram below:

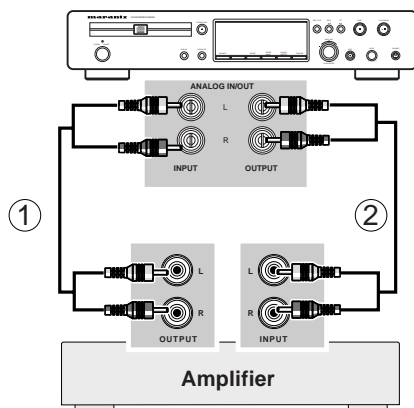

- 1 **For recording**, connect cable ① between the **ANALOG INPUT-sockets on the CD-Recorder** and the **CD LINE- or TAPE OUTPUT-sockets** of an amplifier.
- 2 **For playback**, connect cable ② between the **ANALOG OUTPUT-sockets on the CD-Recorder** and the **ANALOG INPUT-sockets** of an amplifier e.g. TAPE IN, DAT or DCC.

Note:

Never use the PHONO input.

Digital Coaxial connections

For recording and playing, connect the CD-Recorder to a digital amplifier or other equipments based on the diagram below:

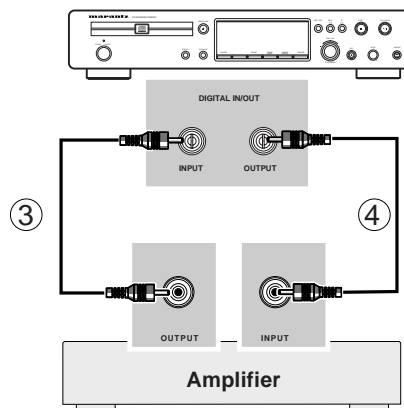

- 1 **For an external recording**, connect the cable ③ between the **DIGITAL INPUT-socket on the CD-Recorder** and the **DIGITAL OUTPUT-socket** of an external amplifier or CD player.
- 2 **For playback**, connect cable ④ between the **DIGITAL OUTPUT-socket on the CD-Recorder** and the **DIGITAL INPUT-socket** of an amplifier e.g. DAT or DCC.

INSTALLATION

Digital Optical connections

For recording and playing, connect the CD-Recorder to a digital amplifier or other equipments based on the diagram below. Before connection the cables, remove the dust caps from the digital optical connections. We recommend that you save the caps.

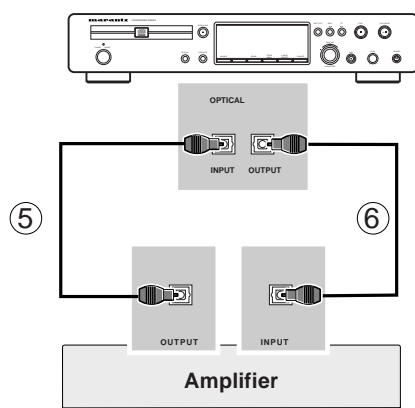

- 1 **For external recording**, connect a fiber-optic cable ⑤ between the **DIGITAL OPTICAL INPUT** of the CD-Recorder and the **DIGITAL OPTICAL OUTPUT** of an external amplifier or CD player.
- 2 **For playback**, connect cable ⑥ between the **OPTICAL OUTPUT-socket on the CD-Recorder** and the **DIGITAL OPTICAL INPUT-socket** of an amplifier e.g. DAT or DCC.

Note:

For playback, the digital coaxial outputs or analog outputs of the CD Player and CD-Recorder should be connected to an amplifier

D-BUS CONNECTION

Remote control cable connections

By connecting DR6000 to the Marantz amplifier using a D-BUS remote control cable ⑦, you can operate the operations of DR6000 from the remote control of the amplifier. **Set the remote control selector to 'EXTERNAL'.**

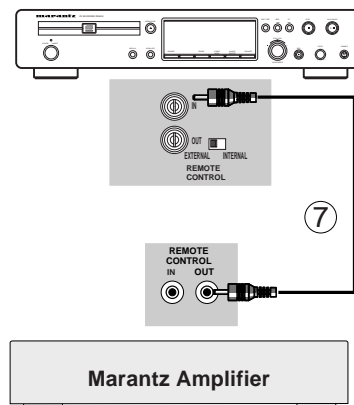

Note:

When you don't use the D-BUS connection, ALWAYS set the remote control selector to 'INTERNAL'.

USING THE RECORDER

The numbers between parentheses refer to the fold-out.

Switching ON and OFF

- 1 Connect the power cord into the mains.

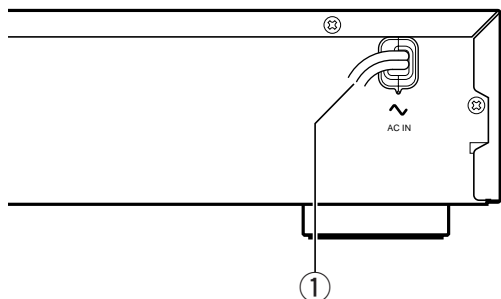

- 2 Press the **POWER ON/OFF (1)** button on the front of the CD-Recorder to turn it on or off.

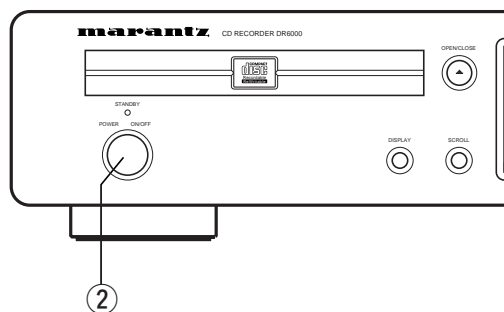

Using the remote control

- 1 Open the battery compartment cover.
- 2 Insert 2 batteries (AA, LR-6 or UM-3; as supplied) as shown.
- 3 Replace the cover.

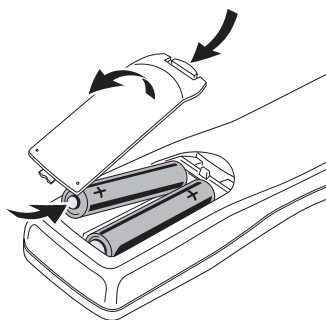

Note:

- We recommend you use **2 batteries of the same type and condition.**
- Always **point the remote control directly towards the recorder** and make sure there.

This remote control can switch "STANDBY ON/OFF" but cannot switch "POWER ON/OFF" the CD-Recorder.

Batteries contain chemical substances, so they should be disposed of properly.

Inserting discs

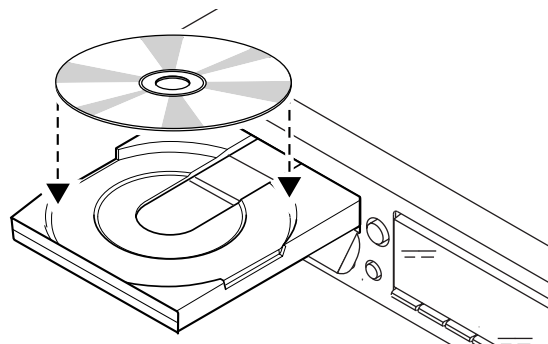

- 1 Press **▲ OPEN/CLOSE (6)** to open the disc tray.
→ **OPEN** lights up.
- 2 Insert a CD, CD-R or CD-RW in the appropriate recess in the tray, label side up.
- 3 Press **▲ OPEN/CLOSE (6)** to close the tray.
→ **CLOSE** lights up, followed by **READING** and the display will show the type of disc you inserted.

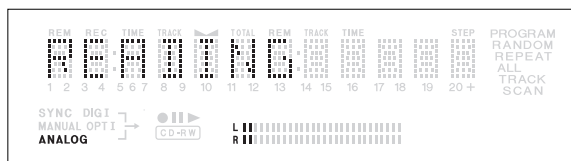

- If a CD-R(W) is finalized it will show CD on the display.
- If CD-text is available the TITLE/ARTIST will scroll by.

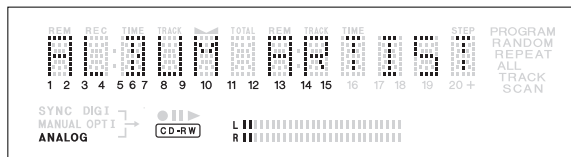

Note:

- **Only Audio CDs will be accepted.** If a non-audio disc is inserted, the display shows **WRONG DISC**.
- For recording it is important that the blank disc is completely free from dust particles or scratches. (see Compact Discs page 1).
- If you insert a blank or partly-recorded CD-R or unfinalized CD-RW, the CD-Recorder will calibrate the disc for optimum recording. During this process the display will first show **INITIALIZING** and then the number of audio tracks. Calibration can take up to 25 seconds.

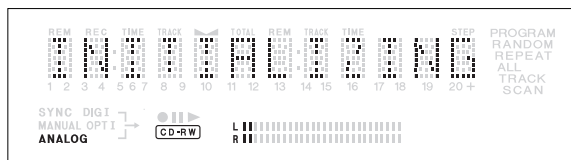

RECORDING

The numbers between parentheses refer to the fold-out.

Remarks about recording

You will soon discover how easy it is to make your own CDs. Nevertheless, it is advisable to use a CD-RW disc for your first try.

- **If the disc is a CD-RW and is already finalized you must unfinalize it first.**
- The recording procedure is the same for CD-Rs and CD-RWs.
- If the disc already contains recordings, the CD-Recorder will automatically search for the end of the last track, so that recording can start from there.
- **There must be at least 7 seconds of recording time left on the disc,** otherwise you will not be able to enter record standby mode. **IDES NOT FIT** then lights up.
- If the display indicates **COPY PROTECT**, no digital recording can be made of the source material. Recording will not start.
- **The Serial Copy Management System (SCMS) only allows digital recording under specific conditions:**
 - This means that it is not possible to make a digital copy from a digital copy.
 - Analog recording is always possible !
 - The number of recordings from the original is unlimited.

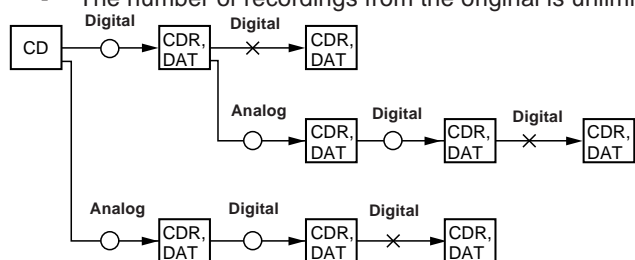

O : Can be recorded.
X : Cannot be recorded.

- A maximum of 99 tracks can be recorded on a disc. Minimum allowable track length is 4 seconds.
- Recordings from DAT or DCC players will not always stop automatically.

Important:

If you want to play the recorded CD-R disc on any regular CD player, it must first be finalized. (See FINALIZING/UNFINALIZING.)

Finalized CD-RW discs play only on CD-RW compatible CD players.

Recording modes

Your recorder offers several recording modes.

- **RECORD DISC** - to make a synchronised recording of the complete disc or a program simply by starting the source.
- **RECORD TRACK** - to make a synchronised recording of a single track simply by starting the source.
- **REC MANUAL** - to manually start a recording simply by pressing the REC key.
- **MAKE []** - to make a synchronised recording of the complete disc or a program simply by starting the source. Finalizing will be done automatically.

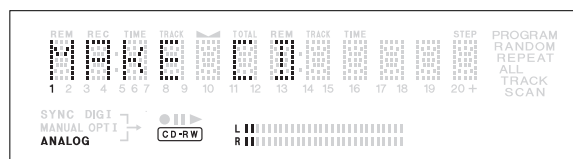

Some remarks on recording:

- When **Auto track** is on (default setting), **track numbers will automatically be increased during recording.**
- By programming tracks first, a compilation can be recorded.
- If a finalized CD recordable disc is inserted in the CD-Recorder, **FINALIZE []** will be displayed. **Recording is not possible.**
- If a finalized CD rewritable disc is inserted in the CD-Recorder, **UNFINALIZE** and **PRESS ENTER** will be displayed when the **REC TYPE (20)** is pressed. If **PUSH ENTER (12, 65)** is pressed, the disc will be unfinalized.
- When you copy a special disc such as HDCD or DTS, you have to
 - set the sampling frequency at 44.1kHz.
 - use the digital connection.
 - set the digital rec-volume of the CD-Recorder at 0 dB.
- When you copy the tracks from a DAT recorded by different sampling frequencies, noise might be recorded in the disc. Please set a sampling frequency for every track in a DAT.
- This CD-Recorder can record about 17 seconds of a pause time, which decreases the time count just before music start in a track on the display. If you record a track including more than 17-seconds-pause time by digital recording, the pause time will be recorded the different length of time from original. However, the entire track time will not be changed and be able to listen to the music as same as original.

Warning:

No more recording possible after finalizing CD-R disc!



RECORDING

The numbers between parentheses refer to the fold-out.

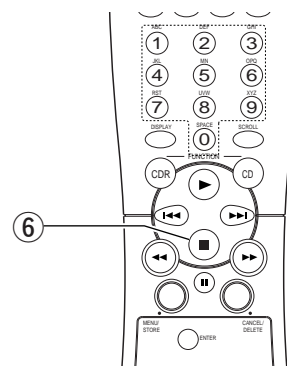
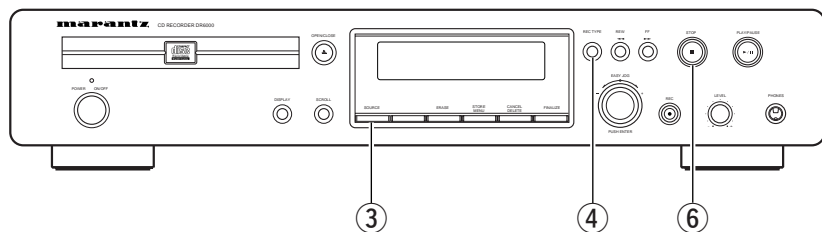

CD-SYNC

The CD-SYNC feature enables you to make fast and easy recordings of a CD. Track increments are automatically detected from the source material. Track increments cannot be added manually. In analog source material a silence of 2.7 seconds or more is automatically detected as a track increment.

- ① Make sure the disc is absolutely free of scratches and dust particles.
- ② Connect the cable from an external CD player to the CD-Recorder. (see INSTALLATION page 5 and 6.)
- ③ Press **SOURCE** (7) repeatedly until the selected source, appears on the display (depending on the digital connection used):
 - ➔ **DIGI**, **OPT I** or **ANALOG** lights up and **DIGITAL I**, **OPTICAL** or **ANALOG** appears on the display.

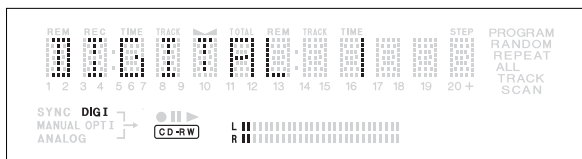

- ④ With the CD-Recorder stopped, press **REC TYPE** (20).
 - once: to select **RECORD DISC**;
 - twice: to select **RECORD TRACK**;
 - four times: to select **MAKE CD**;
 - ➔ **REC** and **SYNC** start to flash.

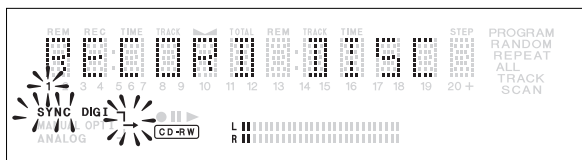

- ⑤ To start recording, press **PLAY** on the selected source.
 - ➔ The CD-Recorder automatically starts to record. The recording time left appears on the display.
 - If, however, you start the source during a track, CD-SYNC recording starts at the beginning of the next track or after 2.7 seconds of silence in analog recordings.
 - To check the elapsed recording time, press **DISPLAY** (4, 58). (This can also be done during recording)
 - The recorder stops automatically.
- ⑥ To stop recording manually, press **STOP** (17, 68).
 - If **STOP** (17, 68) was pressed within 3 seconds after pressing **PLAY** on the selected source, no recording will take place.
 - To interrupt recording, press **PLAY/PAUSE** (16) or **PAUSE** (63). To resume, press **REC** (13) on the CD-Recorder.

After recording the display will show **UPDATE** for several seconds.

Note:

- Recordings from DAT, DCC or analog sources will only stop after 20 seconds silence.
- **MAKE CD** is a recording mode for auto finalized after synchronized recording. It takes about 1 minute to start auto finalizing after finish recording the last track. (**WAIT** appears on the display.) If you press **STOP** (17, 68) during **WAIT** on the display, auto finalizing will be canceled.

Important:

If you want to play the recorded CD-R(W) disc on any regular CD player, it must first be finalized. See finalizing discs.

Finalized CD-RW discs play only on CD-RW compatible CD players.

RECORDING

The numbers between parentheses refer to the fold-out.

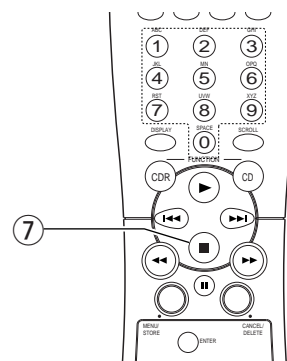
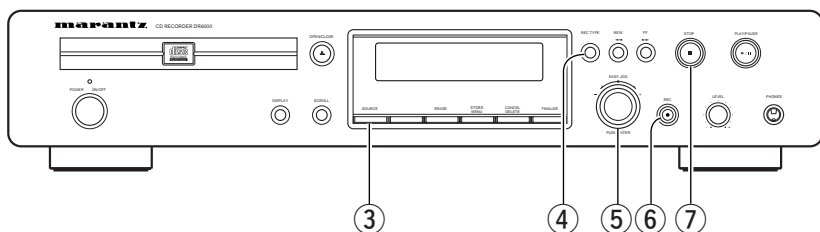

Manual start recording

Manual recording from external CD player.

- ① Make sure the disc is absolutely free of scratches and dust particles.
- ② Connect the cable from an external CD player to the CD-Recorder. (see INSTALLATION page 5 and 6.)
- ③ Press **SOURCE** (7) repeatedly until the selected external source appears on the display (depending on the connection used):
 - ➔ **DIGI**, **OPT I** or **ANALOG** lights up and **DIGITAL**, **OPTICAL** or **ANALOG** appears on the display.

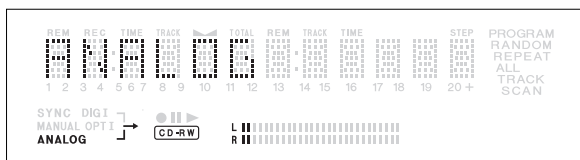

About Auto Track increment

- When Auto Track is ON (default setting), track numbers will automatically be increased during recording.
 - To switch off the Auto Track function you have to enter MENU MODE.
If you wish to increase track numbers manually, press TRACK INCR(ement) on the remote control. For further instructions see MENU MODE.
- ON (AUTO):** The track increments are automatically taken over from the digital source material or after 2.7 seconds silence during analog recording.
- OFF (MANUAL):** Track numbers can be incremented manually by pressing TRACK INCR(ement) (54) on the remote control. (Minimum track length is 4 sec.)
- Track numbers cannot be changed after recording.

Note:

Auto track works only with Consumer Sources with a digital output signal according to the IEC 958 (consumer part) audio standard.

- ④ With the recorder stopped, press **REC TYPE** (20) three times to enter the Manual Record standby mode.
 - ➔ **MANUAL** starts to flash and the display shows **REC MANUAL**.

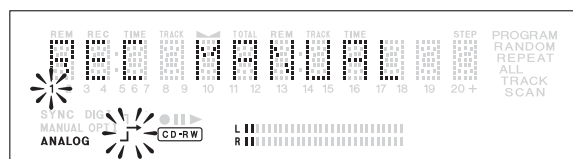

- If **CHECK INPUT** message also flashes, the digital connection is incorrect.
- ⑤ Set the optimal recording level on the CD-Recorder.
 - ① Play the source first to set the optimal recording level on the CD-Recorder.
 - ② Rotate the **EASY JOG** (12) key until, on the Record/Play Level bar, all the white segments are alight, but the red segments do not light continuously during the loudest passages.
DIGITAL RECORDING : +6dB ~ -63dB
ANALOG RECORDING : 0dB ~ -63dB
 - ③ Stop the source.
 - ⑥ To start recording, press ● **REC** (13) on the CD-Recorder and immediately start the source (from Stop-mode).
The track number and recording time left appear on the display.
 - To record a 3-second silence at the start of a track, press ►/|| **PLAY/PAUSE** (16) on the CD-Recorder before starting the source.
 - To check the elapsed recording time, press **DISPLAY** (58) on the CD-Recorder. (This can also be done during the recording.)
 - ⑦ To stop recording, press ■ **STOP** (17, 68).
 - If ■ **STOP** (17, 68) was pressed within 3 seconds after ● **REC** (13), no recording will take place.
 - To interrupt recording, press ►/|| **PLAY/PAUSE** (16) or || **PAUSE** (63).
After recording the display will show **UPDATE** for several seconds.

Important:

If you want to play the recorded CD-R disc on any regular CD player, it must first be finalized. See finalizing discs.

Finalized CD-RW discs play only on CD-RW compatible CD players.

FINALIZING/UNFINALIZING

The numbers between parentheses refer to the fold-out.

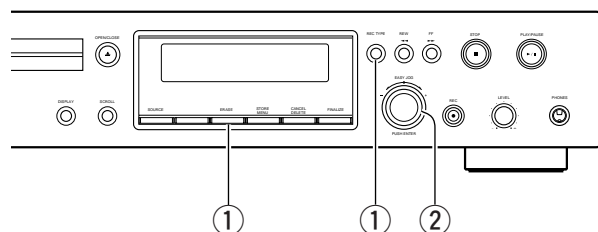
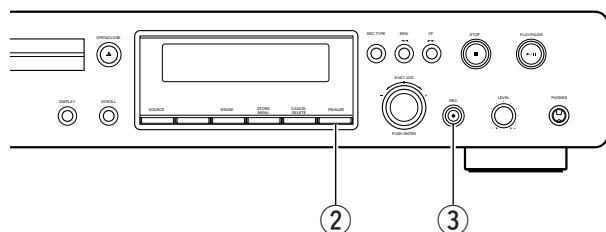

ENGLISH

Finalizing CD-R & CD-RW discs

Finalizing is a simple procedure, necessary to:

- be able to play the recorded CD-R(W) disc on a CD PLAYER.
- avoid further unwanted recordings on a disc.
- avoid erasure of tracks on a CD-RW.

Auto finalizing

Auto finalizing is possible when using the **MAKE CD** recording function.

Manual finalizing

- 1 **Make sure the disc (in the CD-Recorder) is absolutely free of scratches and dust particles.**
- 2 **With the recorder stopped press FINALIZE (11).**
 → The display shows **FINALIZE CD** and **PRESS RECORD**.

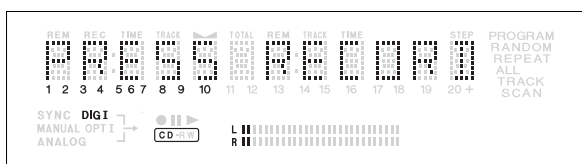
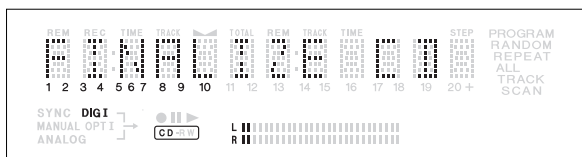

- 3 **Press ● REC (13).**
 → **xxxx FINAL** and the approximate finalization time appears on the display. The display counts down through the finalization. On completion, the total number of tracks and the total time recorded appears on the display. For CD-R(W), CD-R(W) changes to CD on display.

Finalizing will take at least 2 - 4 minutes.

Note:

During finalization, the CD-Recorder accepts no operating commands.

Unfinalizing CD-RW discs

For CD-RW discs only.

If you want to make more recordings (or erasures of tracks) on a finalized disc you must unfinalize it first. The Table of Contents (TOC) will be removed.

- 1 **With the CD-Recorder stopped, press REC TYPE (20) or ERASE (8).**
 → **UNFINALIZE** and **PRESS ENTER** will appear on the display.

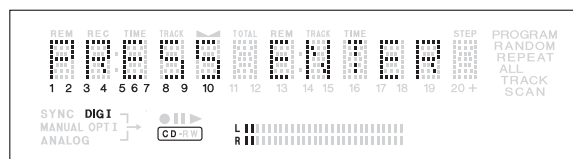
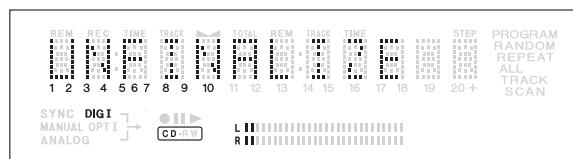

- 2 **Press PUSH ENTER (12).**
 → The disc will now be unfinalized and can be recorded on again.

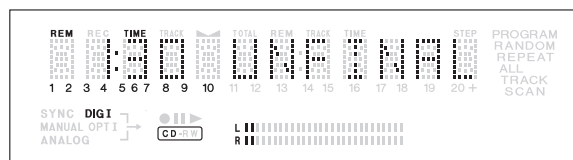

Note:

- Unfinalizing will take approximately 1.5 minutes.
- When unfinalizing a CD-RW disc with text on it available, this text will be transferred to the CD-Recorder memory. It may occur that the text memory is full. The message **MEMORY FULL/FINALIZE CD** will be displayed. You will now have to erase text, stored for other discs, or finalize another disc in order to obtain memory space.

ERASING

The numbers between parentheses refer to the fold-out.

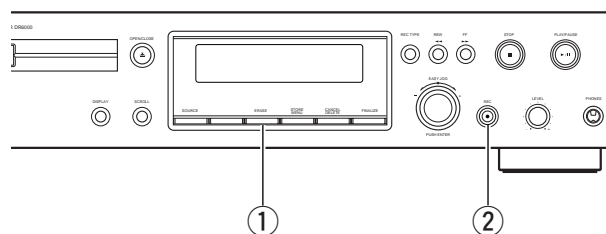
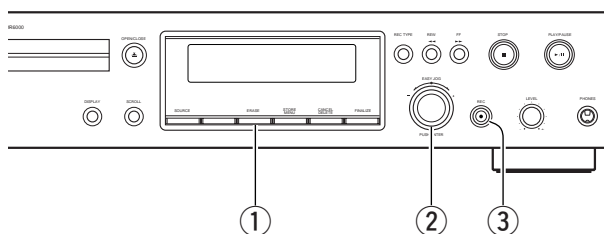

Erasing

For unfinalized CD-RW discs only.

You can erase:

- one or more tracks from the end,
- the entire disc.

Erasing one or more tracks from the end

① Press **ERASE (8)** once.

➔ The display shows the number of tracks and their total playing time. **ERASE TRACK** and **PRESS RECORD** lights up.

- If the disc is finalized, CD appears on the display after inserting a CD-RW in the recorder. The recorder will ask you to confirm unfinalizing first. Confirm by pressing the **PUSH ENTER (12)** key or **ENTER (65)** on the remote control.

② Select the track(s) you wish to erase by turning the **EASY JOG (12)** key to the left and confirm by pressing this key.

- ➔ The selected track numbers start blinking on the track bar.
- ➔ The display shows the remaining number of tracks and the remaining playing time after erasing the selected track(s).

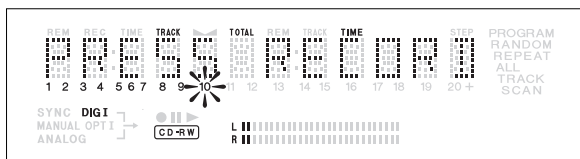
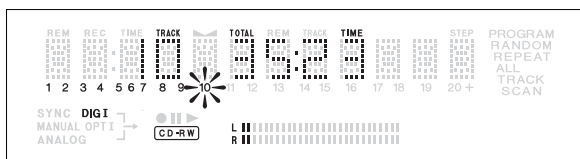

③ Press **REC (13)**.

- ➔ The display shows the total countdown time and **ERASE** appears on the display.
- ➔ After the selected track(s) have erased, the display shows the remaining tracks and their total playing time.

Erasing the entire disc

① Press **ERASE (8)** twice.

➔ The display shows the number of tracks and their total playing time. **ERASE DISC** and **PRESS RECORD** light up.

- If the disc is finalized, CD appears on the display after inserting a CD-RW in the recorder. The recorder will ask you to confirm unfinalizing first. Confirm by pressing the **PUSH ENTER (12)** key or **ENTER (65)** on the remote control.

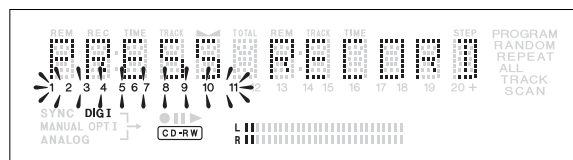
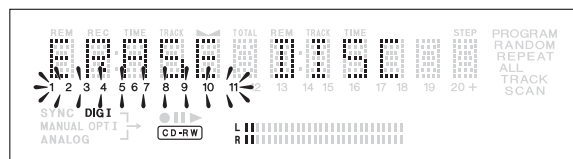

② Press **REC (13)**.

➔ The display shows the total countdown time and **ERASE** appears on the display. The complete disc will be erased.

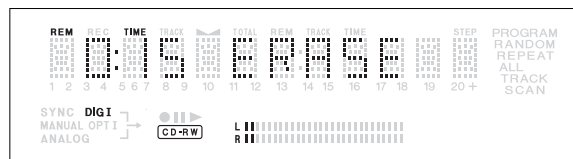

Erasure of a complete disc may take up to 15 seconds.



PLAYING

The numbers between parentheses refer to the fold-out.

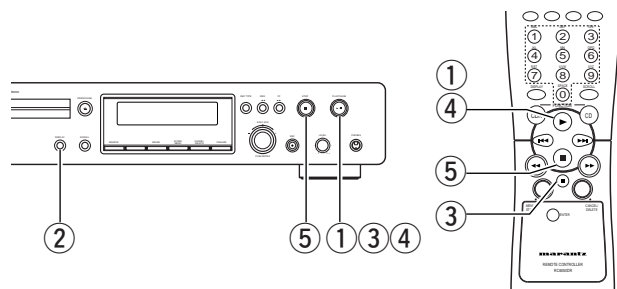

EX: Selecting a track when CD play is stopped

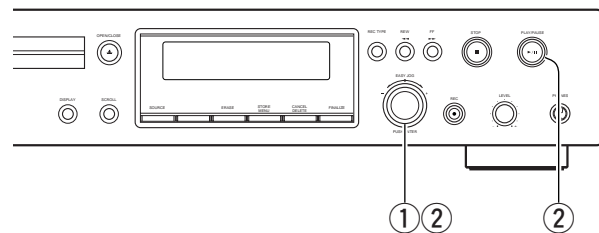

Playing a CD

- ① Press **▶|| PLAY/PAUSE (16, 60)** to start CD play.
 - ➔ ▶ lights up and the track number and track time of the track in play appear on the display.
- ② Press **DISPLAY (4, 58)** once, twice or three times to see:
 - ➔ remaining track time, total remaining time, text information (see MENU MODE page 16).
- ③ To interrupt play temporarily, press **▶|| PLAY/PAUSE (16)** again.
 - ➔ || lights on the display.
- ④ To continue play, press **▶|| PLAY/PAUSE (16, 60)** again.
- ⑤ To stop play, press **■ STOP (17, 68)**.
 - ➔ The number of tracks and the total playing time appear on the display.

Selecting a track

Selecting a track during play

- ① On the DR6000 recorder.
 - Turn the **EASY JOG (12)** key until the required track number appears on the display.
 - ➔ Play skips to the beginning of the selected track.
- ② On the remote control <i>.
 - Key in the required track number using the **NUMERICAL (57)** keys. For 2-digit track numbers, press the keys in rapid succession.
 - ➔ Play skips to the beginning of the selected track.
- ③ On the remote control <ii>.
 - Press **||◀◀ (61)** or **▶▶|| (69)** one or more times.
 - ➔ Play skips to the beginning of the present, previous or subsequent tracks, including tracks on other disc. (Changer mode only.)

Selecting a track when CD play is stopped

- ① On the DR6000 recorder.
 - ① Turn the **EASY JOG (12)** key until the required track number appears on the display.
 - ② Press **PUSH ENTER (12)** to confirm or press **▶|| PLAY/PAUSE (16)** to start playing.
- ② On the remote control <i>.
 - ① Key in the required track number using the **NUMERICAL (57)** keys. For 2-digit track numbers, press the keys in rapid succession. Play starts.
- ③ On the remote control <ii>.
 - ① Briefly press **||◀◀ (61)** or **▶▶|| (69)** one or more times.
 - ② Start playback by pressing **▶ (60)** or **ENTER (65)**.

PLAYING

The numbers between parentheses refer to the fold-out.

EX: Search

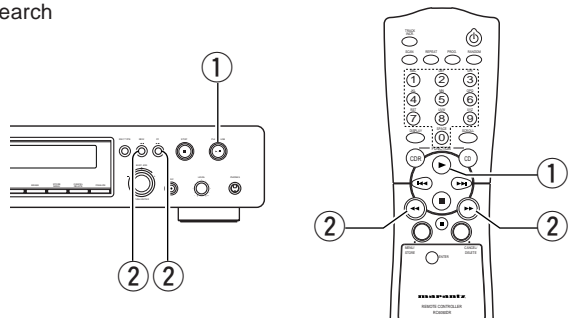

EX: Repeat play

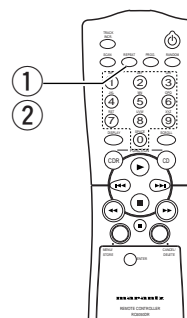

Scan play

- ① To start scan play, press **SCAN (55)** on the remote control.
 - It plays the first 10 seconds of each track.
 - It automatically stops after playing all tracks.
- ② To stop playing, press **■ (17, 68)**.
 - The SCAN level disappears from the display.

Search

- ① Press **▶/■ PLAY/PAUSE (16, 60)**.
- ② Hold down **◀◀ (19, 62)** or **▶▶ (18, 67)**.
 - ➔ The player first searches backwards or forwards at 10 times normal speed with sound at low volume, then goes to 50 times normal speed with sound muted.
- ③ Release the button at the desired passage.
 - ➔ Play starts at the desired passage.

Note:

During Random, Repeat Track or Programmed play, search is restricted to within the track being played at the time.

Random play

- ① Press **RANDOM (73)** before or during CD play to start random play.
 - ➔ The tracks on the CD (or program if set) play in random order.
- ② Press **RANDOM (73)** again to return to normal CD play.

Note:

RANDOM is also cleared if you open the disc tray.
- RANDOM button is only on the remote control.

Repeat play

- ① Press **REPEAT (56)** one or more times during CD play.
 - ➔ When **REPEAT TRACK** lights up, the current track plays repeatedly. When **REPEAT ALL** lights up, the disc or program plays repeatedly.

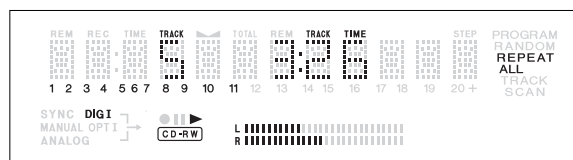

- ② To return to normal play, press **REPEAT (56)** one or more times until:
 - ➔ The REPEAT label disappears from the display.

Note:

- Repeat is also cleared if you open the disc tray.
- REPEAT (56) button is only on the remote control.

PROGRAMMING

The numbers between parentheses refer to the fold-out.

Programmed play

- You can program up to 99 tracks to play in any desired sequence.
- Tracks can be programmed more than once, but each time counts as a track. (step)

Programming for playback

- ① Press **PROG (72)** on the remote control to enter Program mode.
→ **PROGRAM** flashes and **PROGRAM** appears on the display.

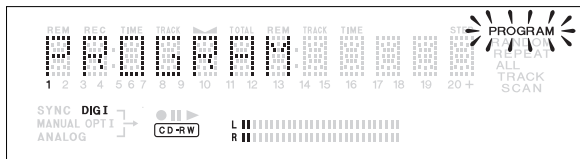

- ② Select the required track numbers by turning the **EASY JOG (12)** key left or right and store by pressing **PUSH ENTER (12, 65)**.

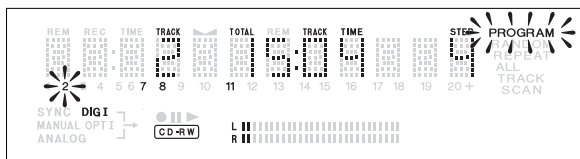

or:

Key in a track number with the NUMBER (57). For 2-digit numbers, press the keys in rapid succession.

- The track will be stored in the program.
- The track number, total program time and the number of programmed tracks (steps) are displayed.

- ③ Repeat step ② for all tracks to be programmed.
- ④ Press **STOP (17, 68)** or **PROG (72)** on the remote control to end programming.
→ **PROGRAM** lights continuously.
- ⑤ Press **▶|| PLAY/PAUSE (16, 60)** to start programmed play.

Clearing a program

- ① Press **■ STOP (17, 68)** if necessary to stop programmed play.
 - ② Press **■ STOP (17, 68)** again to clear the program.
→ **PROGRAM** disappears from the display.
- The program is also cleared if you open the disc tray.

Erasing a track from a program

- ① In Stop mode press **PROG (72)** on the remote control to enter Program mode.
- ② Use **◀◀ (19, 62)** or **▶▶ (18, 67)** to select the track from which to delete.
→ The track number and program step will be shown on the display.
- ③ Press **CANCEL/DELETE (10, 66)** to erase the track from the program.
→ The remaining program steps and the remaining playing time of the program will be displayed.

MENU MODE

The numbers between parentheses refer to the fold-out.

EX: Storing names of Text settings

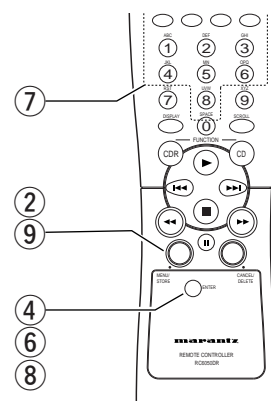
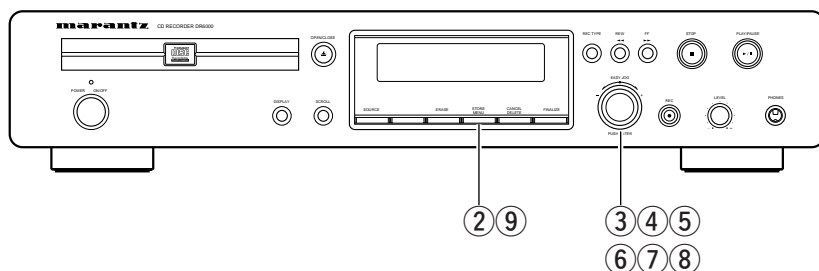

MENU MODE can set up:

- **Text setting** adding erasing the CD text
- **Recording setting** Auto track increment ON/OFF and adjustment of the right-left-volume balance adjustment during the recording
- All settings (except Balance) made in Menu mode will be stored in the deck's memory and can be called up and changed at any time.

Note:

Text can only be edited for unfinalized discs. (finalized CD-RW discs must be unfinalized first)

Text settings

The TEXT submenus allows you to enter text information on the CD-R(W); for example the CD titles, the artist names, the track names and so on. During the playback, the TEXT will be appeared on the display.

Storing names

- ① Stay in the stop mode. (No Operation)
- ② Press **STORE/MENU** (9, 64) on the deck or the remote control to enter Menu mode.
- ③ Rotate **EASY JOG** (12) to select the **TEXT EDIT** submenus.
TEXT EDIT appears on the display.
- ④ Press **PUSH ENTER** (12) or **ENTER** (65) on the remote control to confirm.
- ⑤ Rotate **EASY JOG** (12) to select the required option in the submenu: **ALBUM Artist**, **ALBUM Title**, **Track 1 Artist**, **Track 1 Title**, etc.
- ⑥ Press **PUSH ENTER** (12) or **ENTER** (65) on the remote control to confirm.
- ⑦ Select the characters by rotating the **EASY JOG** (12) or by pressing the corresponding numeric/alphabet key on the remote control.

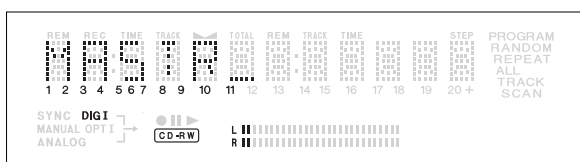

- ⑧ Press **PUSH ENTER** (12) or **ENTER** (65) on the remote control to store the characters and move to the next cursor position.

Note:

- With the **◀◀** (19, 62) **▶▶** (18, 67) keys you can move to a required cursor position.
- With the **CANCEL/DELETE** (10, 66) you can delete a character.

- ⑨ Press **STORE/MENU** (9, 64) to store a name you have entered and return to the submenu or **■ STOP** (17, 68) to exit.

Note:

- A maximum of 60 characters can be stored per item.
- By pressing the **PUSH ENTER** (12) or **ENTER** (65) on the remote control without selecting a character first, you can insert a space between characters.
- When an artist's name has been stored for a certain track, the name will automatically be copied for the next track. The name can be confirmed by pressing **STORE/MENU** (9, 64) or a new name can be entered as described above.

Erasing names

- ① Stay in the stop mode. (No Operation)
- ② Press **STORE/MENU** (9, 64) on the deck or the remote control to enter Menu mode.
- ③ Rotate **EASY JOG** (12) to select the submenu **TEXT ERASE**.
TEXT ERASE appears on the display.
- ④ Press **PUSH ENTER** (12) or **ENTER** (65) on the remote control to confirm.
- ⑤ Rotate **EASY JOG** (12) to select the required option in the submenu: **All Text**, **CD Title**, **CD Artist**, **Track 1 Title**, **Track 1 Artist**, etc.
- ⑥ Press **PUSH ENTER** (12) or **ENTER** (65) on the remote control to confirm.
The display will ask you to reconfirm your selection.
- ⑦ Press **PUSH ENTER** (12) or **ENTER** (65) on the remote control to reconfirm.
- ⑧ Press **STORE/MENU** (9, 64) to return to the submenu or **■ STOP** (17, 68) to exit.



MENU MODE

The numbers between parentheses refer to the fold-out.

Text Memory Review/Erase Text Memory

The input text data of the disc is once saved in the text memory until finalizing the disc. When the text memory is full, MEMORY FULL will appear on the display and unable to add more text data. If you want to add more text data, you have to finalize the text data for each disc in order to obtain memory space or erase the entire memory following the operation below.

- ① Stay in the stop mode. (No Operation)
- ② Press **STORE/MENU** (9, 64) on the deck or the remote control to enter Menu mode.
- ③ Rotate **EASY JOG** (12) to select the **TEXT VIEW** submenu. **TEXT VIEW** appears on the display.
- ④ Press **PUSH ENTER** (12) or **ENTER** (65) on the remote control to confirm.

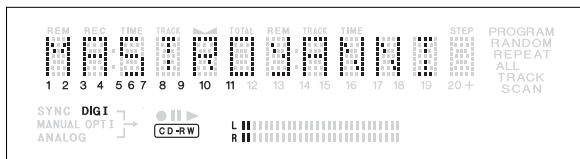

- ⑤ Select the disc you wish to erase.
- ⑥ Press **PUSH ENTER** (12) or **ENTER** (65) on the remote control to confirm. **ERASE MEMORY** appears on the display.

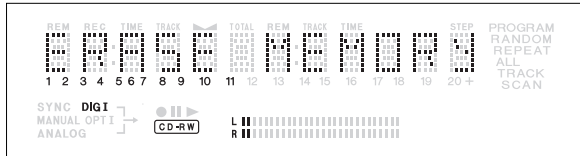

- ⑦ Press the **PUSH ENTER** (12) or **ENTER** (65) on the remote control to confirm the erasure of the text for that particular disc.
- ⑧ Press **STORE/MENU** (9, 64) to return to the submenu or **STOP** (17, 68) to exit.

Note:

- If there are no discs in the memory, the message **MEMORY EMPTY** appears on the display.
- **MEMORY FULL/FINALIZE CD** may also appear when unfinalizing a CD-RW disc for which text was stored (see 'UNFINALIZING CD-RW discs' page 11.). The same action(s) should be taken in order to obtain memory space.

Recording settings

- When Auto Track is ON, track numbers will automatically be increase during the recording.
- You can adjust the right and left volume balance during the recording.

Auto track increment

- ① Stay in the stop mode. (No Operation)
- ② Press **STORE/MENU** (9, 64) on the deck or the remote control to enter Menu mode.
- ③ Rotate **EASY JOG** (12) to select the **AUTO TRACK** submenu. **AUTO TRACK** appears on the display.
- ④ Press **PUSH ENTER** (12) or **ENTER** (65) on the remote control to confirm.
- ⑤ Select Auto track **ON** or **OFF** by rotating **EASY JOG** (12).

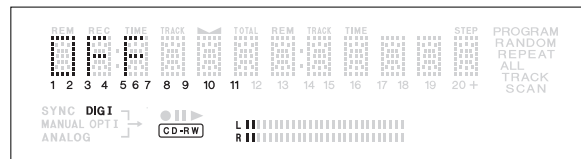

- ⑥ Press **PUSH ENTER** (12) or **ENTER** (65) on the remote control to confirm.
 - When **ON** is selected, track numbers will be automatically incremented during recording.
 - When **OFF** is selected, you can number the recorded tracks yourself.
- ⑦ Press **STORE/MENU** (9, 64) to store settings and return to the submenu or **STOP** (17, 68) to exit.

Balance (Only active in Record/Standby mode)

- ① Press **STORE/MENU** (9, 64) on the deck or the remote control to enter Menu mode.
- ② Rotate **EASY JOG** (12) to select the **SET BALANCE** submenu. **SET BALANCE** appears on the display.

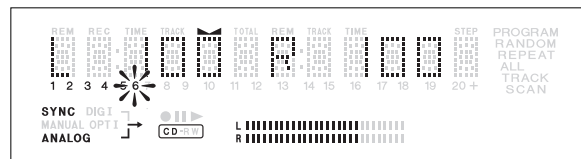

- ③ Press **PUSH ENTER** (12) or **ENTER** (65) on the remote control to confirm.
 - **L 100 R 100** appear on the display.
- ④ Adjust the internal and external recording balance by turning the **EASY JOG** (12).
- ⑤ Press **PUSH ENTER** (12) or **ENTER** (65) on the remote control to confirm.
- ⑥ Press **STORE/MENU** (9, 64) to store settings.

Note:

The balance setting will not be stored.

DISPLAY

Messages, as listed and explained here, may appear on the display for your guidance.

General

- READING..... reading disc information
- OPEN..... during tray opening
- CLOSE..... during tray closing
- NO DISC..... no disc inserted, disc unreadable or disc inserted upside down
- PRG FULL..... program full
- INSERT DISC..... insert disc or insert disc in correct way
- WRONG DISC..... inserted disc is no audio CD
- UNFINALIZE I..... unfinalized CD-R(W) disc
- MEMORY XX%/..... indicates the amount of text memory used for unfinalized discs

Recording

- WAIT..... - when ■ STOP is pressed during recording
- when ■ STOP is pressed during recording the first 4 seconds of a track
- UPDATE..... updating disc contents
- DISC FULL..... no more recording possible
- DIGITAL I..... digital coaxial input selected
- OPTICAL..... digital optical input selected
- ANALOG..... analog input selected
- COPY PROTECT I..... no digital recording can be made of the external source
- NOTFINALIZED I..... when opening the tray with an unfinalized disc inserted (in the CD-Recorder)
- MAKE CD..... Start of synchronised recording of a complete disc and Auto Finalize function selected
- RECORD DISC..... Start of synchronised recording of a complete disc
- RECORD TRACK..... Start of synchronised recording of a single track
- REC MANUAL..... manual start of recording selected
- XX I..... level is being adjusted
- DOES NOT FIT..... time left on CD-R(W) disc is not enough for proposed recording
- ANALOG REC..... copy prohibited track found during recording. Track will be copied analog (Copy Protection Regulations).
- ERASE TRACK..... when erasing one or more tracks
- ERASE DISC..... when erasing a disc
- FINALIZE CD..... when finalizing a disc
- CHECK INPUT..... when REC is pressed while no digital source is detected
- XX XX ERASE..... time countdown when erasing a track or a disc
- XXXX FINAL..... time countdown when finalizing a disc
- PRESS RECORD I..... to start manual recording, finalizing or erasing

- START SOURCE..... to start synchronised recording from a source
- FINALIZE..... when trying to record on a finalized CD-R(W) or a prerecorded CD
- UNFINALIZE..... when trying to record on a finalized CD-RW
- PRESS ENTER..... finalized CD-RW
- PROF SOURCE..... when a professional source is connected

Play

- PROGRAM..... program mode selected
- ALBUM TITLE..... will be followed by album title
- TRACK TITLE..... will be followed by track title
- ALBUM ARTIST..... will be followed by artist name
- TRACK ARTIST..... will be followed by track artist name

Others

- NO AUDIO TR..... when the recorder enters a data track during recording
- FINALIZE CD..... laser power calibration performed 96 times, finalize disc
- INITIALIZING..... during laser power calibration for unfinalized discs
- DISC RECOVER..... during disc recovering after power failure
- OPC ERROR..... OPC failure during OPC procedure (OPC = Optimum Power Calibration)
- RECORD ERROR..... recording error in menu mode
- DISC ERROR..... when trying to record on or finalize a recovered disc
- MEMORY FULL..... when text memory is full. To add a CD to the list, first finalize or erase another disc from the list.
- FINALIZE CD



DISPLAY

Menu messages

- NO TRACKS when attempting to edit text for a disc which has no tracks
- TEXT EDIT when entering Text Edit mode
- ALBUM ARTIST when editing or erasing an artist name
- ALBUM TITLE when editing or erasing a title
- ARTIST TR N when editing or erasing an artist name per track
- TITLE TR N when editing or erasing a title per track
- TEXT ERASE when entering Text Erase mode
- ALL TEXT when entering All Text mode
- ERASE OK when confirmation for erasing has to be given with ENTER key
- ERASE ALL OK when confirmation for erasing has to be given with ENTER key
- ERASE MEMORY when waiting for confirmation when erasing a disc
- TEXT VIEW when selecting text review per unfinalized disc in memory
- MEMORY EMPTY when REVIEW is selected while no text is in memory
- AUTO TRACK when selecting auto track increment ON or OFF
- ON Auto Track increment on
- OFF Auto Track increment off
- SET BALANCE when selecting BALANCE
- NO TEXT no text stored for disc

OTHER INFORMATIONS

Fixing problems

If you think your CD-Recorder is defective, it is wise to read this list first. Maybe you forgot a simple step.

Warning!
Under no circumstances should you attempt to repair the CD-recorder yourself as this will invalidate the guarantee.

No power

- ensure that the **POWER ON/OFF** (1) button is on: the CD-Recorder is in standby mode, press any button to activate it
- ensure that the power cord is plugged in correctly
- switch the recorder OFF and then immediately back ON

Auto track does not work

- check if auto track is selected
- check if there are 2.7 seconds silence in between the tracks (analog recording only)
- check if the source is consumer source with the digital output according to IEC audio standard
- source is DVD disc (no track information)

No sound

- check the audio connections
- if using an amplifier, try using a different source

Amplifier sound is distorted

- check that the CD-Recorder analog output is not connected to the amplifier PHONE input.

Play will not start

- ensure that the label of the CD is facing up
- clean the disc
- check that the disc is not defective by trying another disc

Remote control does not work

- point the remote control directly at the CD-Recorder
- check the batteries and replace if necessary
- select the right source first
- set the remote control selector to 'INTERNAL'

Will not record

- clean the disc
- check if CD-R(W) is an unfinalised disc
- check that the disc is recordable and replace if necessary
- the disc is not an audio disc (WRONG DISC)
- wrong input source chosen.
- text memory full (MEMORY FULL / FINALIZE CD). When a CD-RW has to be unfinalised for recording. Erase text for other disc(s) or finalise other disc(s) to obtain memory space.

Recording is distorted

- make sure the recording level was not too high

20 second pause between recordings

- see 'RECORDING' CD SYNC

OTHER INFORMATIONS

The numbers between parentheses refer to the fold-out.

Player does not react

- use the **POWER ON/OFF** (1) button on the front of the Player to switch it off and back on

DISC RECOVER on display

- a power failure has occurred during recording the CD-Recorder is attempting to repair the disc
- If **DISC ERROR** then appears on the display, the disc cannot be recorded further, and cannot be finalized. But it can still be played on the CD-Recorder or another CD-Recorder.
- on a CD-R(W) disc, the track being recorded is lost, but further recording and finalisation can still be done

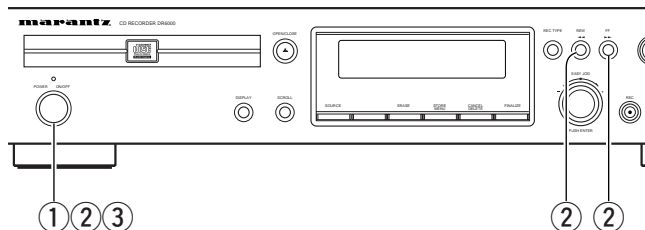

Diagnostic Program

If the malfunction continues, perform the Diagnostic Program:

- 1 Switch the recorder off using the **POWER ON/OFF** (1).
- 2 Simultaneously press the **▶▶** (18) and **◀◀** (19) and switch the recorder back on using the **POWER ON/OFF** (1).
 - ➔ The display will now indicate 'DISP'.
 - ➔ After a few minutes, the message will change to 'ERROR' or 'PASSE I'.
 - ➔ If the **ERROR** message appears, your recorder is defective and needs to be repaired. Consult your supplier or call the Marantz Consumer Line to find the nearest service centre. The number of the Consumer Line can be found in the guarantee booklet.
 - ➔ If the **'PASSE I'** message appears, there is no clear defect and the malfunction may be a result of misinterpretation of the user instructions, an inappropriate disc, a mechanical defect or an incorrect connection. To solve this problem, carefully read the user instructions once again; you can also contact your supplier.
 - ➔ If you cannot solve the problem, go to the nearest service centre.
- 3 Switch off the recorder using the **POWER ON/OFF** (1) to exit from the Diagnostic Program.

ABOUT TEXT

The input text data is saved in the text memory until the disc is finalized. Therefore, the data is not written in the CD-R(W) disc before finalizing the disc.

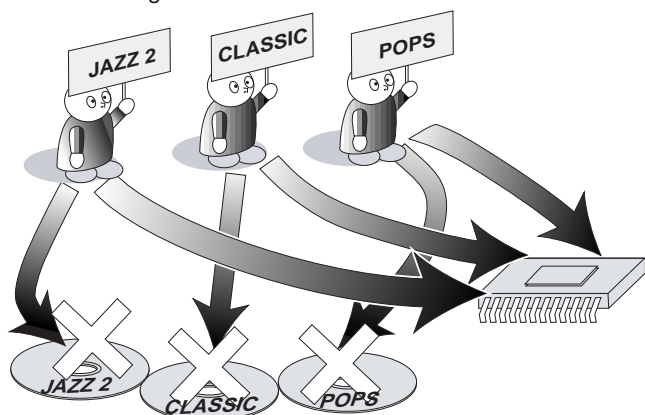

Finalizing the disc transfers the text data from the text memory to the disc.

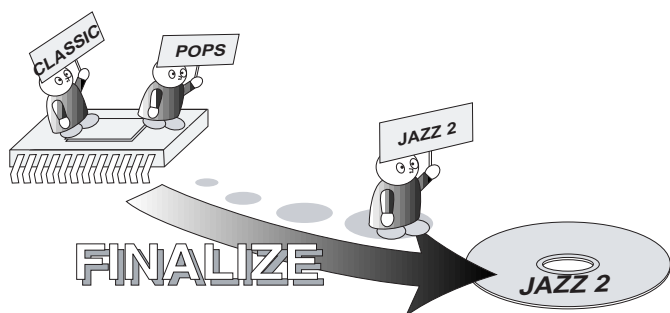

Unfinalizing the disc transfers the text data from the disc to the text memory.

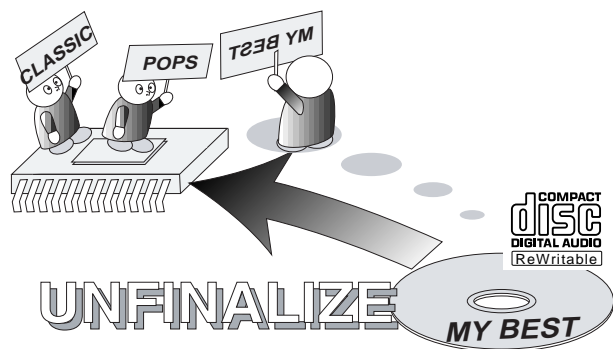

When the text memory is full, MEMORY FULL appears on the display and you cannot add more text data.

In this case, you need to make more space in text memory. You can either finalize one or more disc(s) to transfer the text data to each disc, or erase (part of) the text data in the text memory.

Note:

When the text memory is full depends on the amount of the input text data per disc and the number of discs. Typically the text memory can store for 50 discs of the text data consisting of 60 characters of an artist name or title for 20 tracks.

TECHNICAL SPECIFICATIONS

GENERAL

System	Compact disc digital audio
Number of channels	2 (stereo)
Applicable discs	CD, CD-R (digital audio), CD-RW (digital audio)
Power Requirement	AC 120 V 60 Hz
Power Consumption	24W
Operating Temperature	41 - 95 °F (5 - 35 °C)
Dimension (MAX)	
Width	17-3/8 inches (440 mm)
Height	3-7/16 inches (87 mm)
Depth	12-1/2 inches (317 mm)
Weight	10.1 lbs (4.6 Kg)

AUDIO

Frequency Response	20 Hz - 20 kHz
Playback S/N	105 dB
Playback Dynamic Range	96 dB
Playback Total Harmonic Distortion	90 dB
Recording S/N (analog)	90 dB
Recording Dynamic Range (analog)	92 dB
Recording Total Harmonic Distortion (analog)	84 dB
Analog Output Voltage	2 Vrms
Digital Coaxial Output	0.5 V (p-p)/75 Ω
Digital Optical Output	- 20 dB
Headphones	0 - 5 Vrms/ 8 - 2000 Ω

Recording values for line input

Digital Coaxial Input (automatic sample rate conversion)	32 - 48 kHz
Digital Optical Input (automatic sample rate conversion)	32 - 48 kHz
Analog Input	560 mVrms/ 50 kΩ

Specifications subject to change without prior notice.



COUNTRY	COMPANY	ADDRESS
ALGERIE	Azur 2000	8, Lotissement Ben Hatadi, Alger, Algeria
ARMENIA	NGYIG Ltd.	47 A/75 St. Lalaianis, 375000 Yerevan, Armenia
AUSTRALIA	Scan audio Pty. Ltd.	4 Station Street, Thornleigh NSW 2120, Australia
AUSTRIA	Huber & Prohaska GmbH	Taborstraße 95 / Ladestraße 1, Gebäude Hangartner, A-1200 Wien, Austria
BAHREIN	Ambassador Stores	P.O. Box 237,141, Government Avenue, Manama,Bahrein
BANGLADESH	Target	1078, Ramjoy Mohanja Lane Asadgonj, Chittagong 4000, Bangladesh
BELGIUM	Van der Heyden Audio N.V.	Brusselbaan 278, 9320 Eredebodegem, Belgium
BULGARIA	Ariescommerce GmbH	Makedonia Blvd. 16, 1606 Sofia, Bulgaria
CANADA	Lenbrook Industries Limited	633 Granite Court, Pickering, Ontario
CYPRUS	Empire Hifi systems Ltd.	P.O. Box 5604, Nicosia, Cyprus
CZECH REPUBLIC	Audio International	Sokolska 41, 67902 Rajec, OKR,Blansko, Czech Republic
DENMARK	Audio Nord	Dali Allé 1, 9610 Noerager, Denmark
DUBAI	V.V.& SONS	P.O. Box 105, Dubai, U.A.E.
EGYPT	Solimco	9, El Attibaa St. Doki, Cairo, Egypt
ESTONIA	HiFi Club Estonia	Ehte 4, 90503 Haapsalu, Estonia
F.Y.R.O.M.	T.P. KODI	ul.Cedimir Kantargiev 21a, Skopje, Former Yugoslavian Republic of Macedonia
FINLAND	Audio Nord	Uudenmaankatu 4-6, Helsinki SF-00120, Finland
FRANCE	Marantz France	A division of Marantz Europe B.V., P.O. Box 301, 92 156 Suresnes Cedex, France
GERMANY	Marantz Deutschland	Hakenbusch 3, 49078 Osnabrück, Germany
GREECE	Adamco S.A.	188, Hippocratous Street, 11471 Athens, Greece
HEADQUARTERS EUROPE:	Marantz Europe B.V.	Building SFF-2, P.O. Box 80002, 5600 JB Eindhoven, The Netherlands
HONG KONG	Marantz Asia Ltd.	Unit 1706, Metroplaza II, 223 Hing Fong Road, Kwai Fong, N.T., Kowloon, Hong Kong
HUNGARY	Infovox Ltd.	Terez Krt.31, 1067 Budapest, Hungary
ICELAND	ID Electronics Ltd.	Armula 38, 108 Reykjavik, Iceland
INDIA	NOVA Audio Private	8,Punam Co-op.Society 29/30 Road#5, Union Park MUMBAI 400052, India
IRAN	Home Co.	5th floor no 878 Philips Building Enghelab ave, P.O. 11365/7844 Tehran, Iran
IRELAND	Marantz Ireland	Clonskeagh, Dublin 14, Ireland
ISRAEL	Elmor Ltd.	52 Heh Beiyar Street, Kikar Hamedina, Tel Aviv, Israel
ITALY	Marantz Italy	Via Casati 23, 20052 Monza (Milano), Italy, Servizio Consumatori 1678-20026, Numero Verde
IVORY COAST	Hifivoir	B.P. 2428, Abidjan 01, Ivory Coast
JAPAN	Marantz Japan Inc.	35-1 Sagami Ohno 7-Chome, Sagamihara-shi, Kanagawa 228-8505, Japan
KOREA	Mk Enterprises Ltd.	121-210, 2F Shinhan Bldg., 247-17 Seokyo-dong, Mapo-ku, Seoul, Korea
KUWAIT	alAlamiah Electronics Intl.	P.O. Box 8196, Salmiah 22052, Kuwait
LATVIA	Ace Ltd.	61, LacPlesa Str., Riga LV 1011, Latvia
LEBANON	AZ Electronics S.A., 1,	P.O. Box 11 2833, Beirut, Lebanon
LITHUANIA	Accapella Ltd.	Ausros, Vartu G/5, Pasazo SKG., 2001 Vilnius, Lithuania
MALAYSIA	Wo Kee Hong Electronics Sdn. Bhd.	102 Jalan SS 21/35, Damansara Utama, 47400 Petaling Jaya, Selangordarul Ehsan, Malaysia
MALTA	Doneo Co Ltd.	78 The Strand, Sliema SLM07, Malta
MAURITIUS	SKR Electronics Ltd.	P.O. Box 685, Bell Village, Port Louis, Mauritius
MILITARY MARKET EUROPE	PASCO GmbH	PO BOX 1280, Sandhausen 69200, Germany
NETHERLANDS	Marantz Domestic Sales	A division of Marantz Europe B.V., Building SFF2, P.O. Box 80002, 5600 JB Eindhoven, The Netherlands
NEW ZEALAND	Scan audio Pty. Ltd.	4 Station Street, Thornleigh NSW 2120, Australia
NORWAY	Audio Nord	Sandkerveien 64, Oslo 0483, Norway
OMAN	Mustafa & Jawad Trading CO.	P.O. Box 1918, Ruwi, Oman
POLAND	Philips Polska Sp. z.o.o.	Al.Jerozolimskie 195b, 02 222 Warszawa, Poland
PORTUGAL	Corel2	Comércio de Electrónica Lda., Av. Luís Bivar, No 85 A, 1050 Lisboa, Portugal
PROFESSIONAL EUROPE	Marantz Professional Products	Kingsbridge House, Padbury Oaks, 575-583 Bath Road, Longford, Middlesex UB7 0EH, U.K.
PROFESSIONAL U.S.A.	Marantz Professional Products	Distributed by: Superscope Technologies Inc., 1000 Corporate Blvd. Ste.D, Aurora, Illino
QATAR	Almana & Partners W.W.L.	P.O. Box 49, Doha, Qatar
REUNION	Vision +	180 Rue du Marechal Leclerc, 97400 Saint Denis, Ile de la Reunion
ROMANIA	Nova Music Entertainment	5, Zagazului Str. Bl.1G,apt.18, sector 1,Bucharest, Romania
RUSSIA	Absolute Audio	7/2, Montazhnaya Street, 107497 Moscow, Russia
SAUDI ARABIA	Adawlia Univ. Electr. Apl	P.O. Box 2154, Alkhobar 31952, Saudi Arabia
SINGAPORE	Forward Marketing (S) Pte. Ltd.	Wo Kee Hong Centre, 29 Leng Kee Road, Singapore 159099, Singapore
SLOVAKIA	Bis Audio s.r.o.	Nam. SNP 10, 96001 Zvolem, Slovakia
SLOVENIA	Bofex	Smartinska 152, HALA V/3, 61000 Ljubljana, Slovenia
SOUTH AFRICA	Coherent Imports (PTY) Ltd.	P.O. Box 1614, Alberton, 1450, South Africa
SPAIN	Marantz Spain	Martinez Villergas 2, Apartado 2065, Madrid 28027, Spain
SRI LANKA	The listening Room	Mezzanine Floor, The Landmark 385, Galle Road, Colombo - 3, Sri Lanka
SWEDEN	Audio Nord	Almedalsvagen 4, Gotenborg 402-23, Sweden
SWITZERLAND	Sound Company AG	Postfach, 8010 Zürich, Switzerland
SYRIA	Hamzeh & Partners	Hafez Ibrahim Str. No 117, Damascus Shalan, Syria
TAHITI	Covecolor	Av. Prince Hinoi, Cours de l'union sacré, P.O. Box 2334, Papeete, Tahiti
TAIWAN	Pai-Yuing Co. Ltd.	6th No 148 Sung Kiang Road, Taipei 10429, Taiwan R.O.C.
THAILAND	MRZ Standard Co. Ltd.	746-750 Mahachai Road, Wangburapa, Bangkok 10200, Thailand
TUNESIA	Societe EDEVIG	40, Avenue du Golfe Arabe, El Menzah, 1004, Tunesia
TURKEY	Türk Philips Ticaret A.S.	Yukari Dudullu Organize sanayi Bolgesi, 2.Cadde no.28, 81260 Umraniye-Istanbul, Turkey
U.K.	Marantz Hifi UK Ltd.	Kingsbridge House, Padbury Oaks, 575-583 Bath Road, Longford, Middlesex UB7 0EH, U.K.
U.S.A.	Marantz America Inc.	440 Medinah Road, Roselle, IL 60172, U.S.A.
YUGOSLAVIA	ITM Company	Omladinskih Brigada 86, 11070 Belgrade, Yugoslavia
EXPORT	Marantz Domestic Sales	A division of Marantz Europe BV,Building SFF2, P.O. Box 80002, 5600 JB Eindhoven, TheThe Netherlands

www.marantz.com

marantz® is a registered trademark.



Printed in Japan

00/05 MIT 385K851250

