



marantz®

CD Player **CD5005**

You can print more than one page of a PDF onto a single sheet of paper.

Owner's Manual

[Front panel](#)[Display](#)[Rear panel](#)[Remote](#)[Index](#)

Accessories	4
Inserting the batteries	5
Operating range of the remote control unit	5
Features	6
High quality sound	6
High performance	6
Part names and functions	7
Front panel	7
Display	9
Rear panel	10
Remote control unit	11

Connections

Connecting to a stereo audio amplifier	18
Connecting to a device with digital audio input connectors	19
Connecting devices with remote control connectors	20
Connection	20
Setting	20
Connecting the timer device	21
Connecting the power cord	22

Playback

Basic operation	24
Turning the power on	24
Switching the display's brightness	25
Switching the sound mode	25
Playing CDs	26
Playing CDs	26
Changing the playback speed (Pitch control playback)	28
A-B repeat playback	29
Playing tracks in a specific order (Program playback)	29
Skipping tracks you don't want to hear (Delete program playback)	30
Switching the display (CD-TEXT)	31
Playing DATA CDs (MP3 and WMA files)	32
Playing files	33



Settings

Menu map	35
Menu operation	36
Digital Out	37
Timer Play	37
Display Info	38
Auto Standby	38

Tips

Tips	40
Troubleshooting	41

Appendix

Playable media	44
Discs	44
Files	44
Playback order of MP3/WMA files	45
About discs and files	46
Cautions on using media	47
Inserting a disc	47
How to handle media	48
Cleaning discs	48
Explanation of terms	49
Specifications	50
Index	53





Thank you for purchasing this Marantz product.

To ensure proper operation, please read this owner's manual carefully before using the product.

After reading this manual, be sure to keep it for future reference.

Accessories

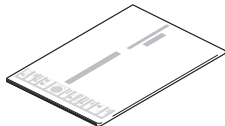
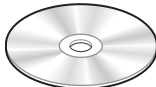
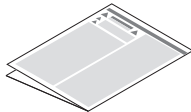
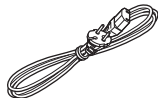
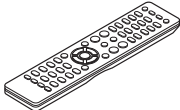
Check that the following parts are supplied with the product.

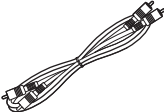
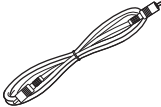
 Quick Start Guide	 CD-ROM (Owner's Manual)	 Safety Instructions	 Power cord
 Remote control unit (RC002PMCD)	 R03/AAA batteries	 Audio cable	 Remote connector cable



Inserting the batteries

- 1 Remove the rear lid in the direction of the arrow and remove it.

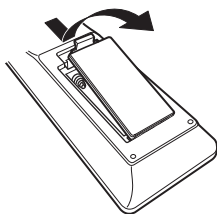

- 2 Insert two batteries correctly into the battery compartment as indicated.

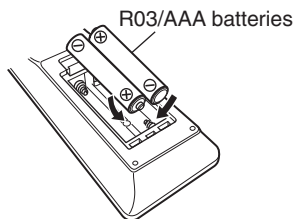

- 3 Put the rear cover back on.

NOTE

- When inserting the batteries, be sure to do so in the proper direction, following the ⊕ and ⊖ marks in the battery compartment.
- To prevent damage or leakage of battery fluid:
 - Do not use a new battery together with an old one.
 - Do not use two different types of batteries.
- Remove the batteries from the remote control unit if it will not be in use for long periods.
- If the battery fluid should leak, carefully wipe the fluid off the inside of the battery compartment and insert new batteries.

Operating range of the remote control unit

Point the remote control unit at the remote sensor when operating it.

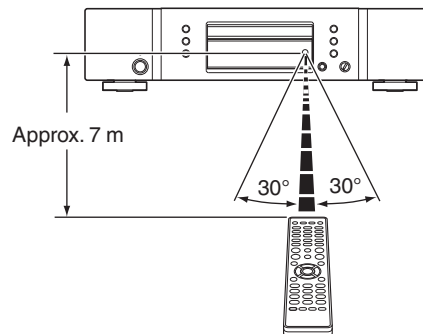

Features

High quality sound

- Using Marantz original HDAM® SA2 circuit**
 The unit uses an HDAM® SA2 circuit, whose quality has been proved in Super Audio CD players and high-end amplifiers, as a high-speed buffer amplifier.
 You can enjoy the high speed and high-quality sound like that produced by high-end equipment.
- Incorporates a Cirrus Logic advanced D/A converter, CS4398**
 A D/A converter is an essential element for the audio quality of a CD player. The CS4398 Cirrus Logic D/A Converter, which has a reputation for high precision and has been adopted for other Marantz Super Audio CD players, is adopted for this unit.
- Equipped with Audio EX function (☞ p. 25)**
 When digital output or the display are set to off, you can enjoy high quality analog output sound.
- High grade headphone circuit**
 The high-grade headphone circuit incorporates a high-speed buffer amplifier to enable headphone listening of high quality sound reproduction, late at night or in other such situations.

High performance

- Equipped with pitch control function (☞ p. 28)**
 The CD playback speed (pitch) can be changed within a ± 12 stage range.
 This function is useful for dancing practice, language learning, etc.
- Supports MP3 and WMA file playback (☞ p. 32)**
 MP3 and WMA files that have been recorded onto CD-R or CD-RW discs can be played back on this CD player.
- Supports CD-TEXT display**
 CD-Text is an extension to the existing audio CD standard that enables text information, such as the name of the artist, album title and song titles to be stored on an audio CD. CDs with the following logos support this function.





- Large 16-character / 2-line display**
 Text information appears on the large display during MP3 playback.

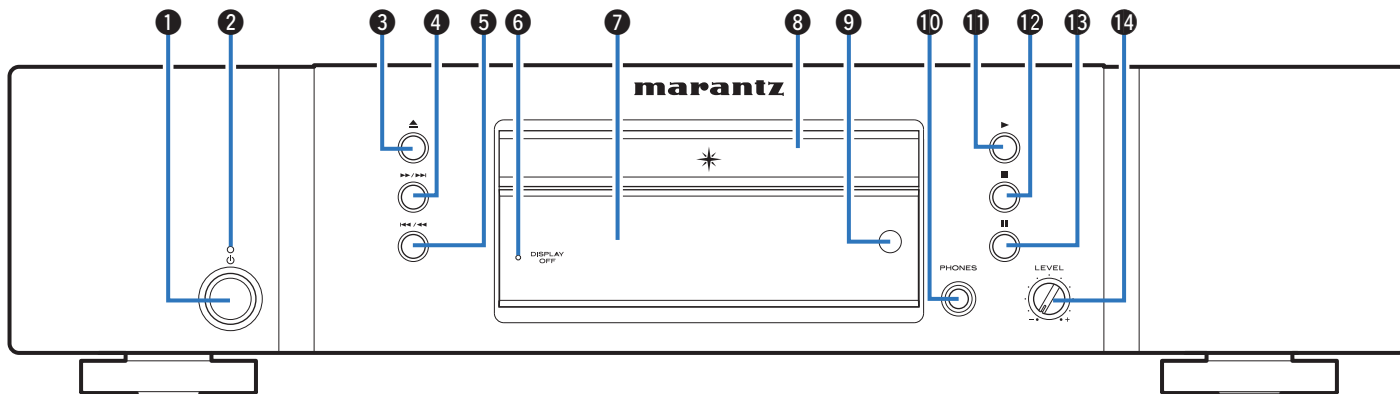

Part names and functions

Front panel



1 Power operation button (⏻)

This turns the power on/off (standby). (☞ p. 24)

2 Power indicator

This is lit as follows according to the power status:

- Power on : Off
- Standby : Red

3 Disc tray open/close button (▲)

Opens and closes the disc tray. (☞ p. 26)

4 Fast-forward/Forward-skip button (▶▶/▶▶|)

Plays the next track. Press and hold to fast-forward the track. (☞ p. 27, 33)



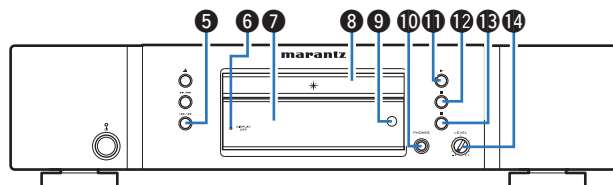

5 Fast-reverse/Reverse-skip button (⏮/⏪)

Returns to the start of the currently playing track. Press and hold to fast-reverse the track. (🔗 p. 27, 33)

6 DISPLAY OFF indicator

Lights when the display is off. (🔗 p. 25)

7 Display

This displays various pieces of information. (🔗 p. 9)

8 Disc tray

Used to insert a disc. (🔗 p. 26)

9 Remote control sensor

This receives signals from the remote control unit. (🔗 p. 5)

10 Headphones jack (PHONES)

Used to connect headphones.

NOTE

To prevent hearing loss, do not raise the volume level excessively when using headphones.

11 Play button (▶)

Playback starts. (🔗 p. 27, 33)

12 Stop button (■)

Stops playback. (🔗 p. 27, 33)

13 Pause button (⏸)

Pauses playback. (🔗 p. 27, 33)

14 Headphone volume control knob (LEVEL)

Adjusts the headphone volume.



Display

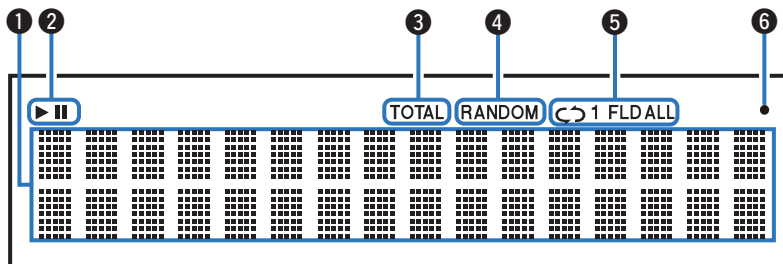

1 Information display

Displays various information or playback elapsed time and so on of the disc.

2 Playback mode indicators

▶ : Lights up during playback.

|| : Lights up during pause.

3 TOTAL indicator

Lights when the total number of tracks and total time of the CD are displayed.

4 RANDOM indicator

Lights during random playback.
(☞ p. 27, 33)

5 Repeat mode indicators

Lights to match the repeat mode settings.
(☞ p. 27, 33)

6 Remote control signal reception indicator

Lights when a signal is received from the remote control.



Rear panel

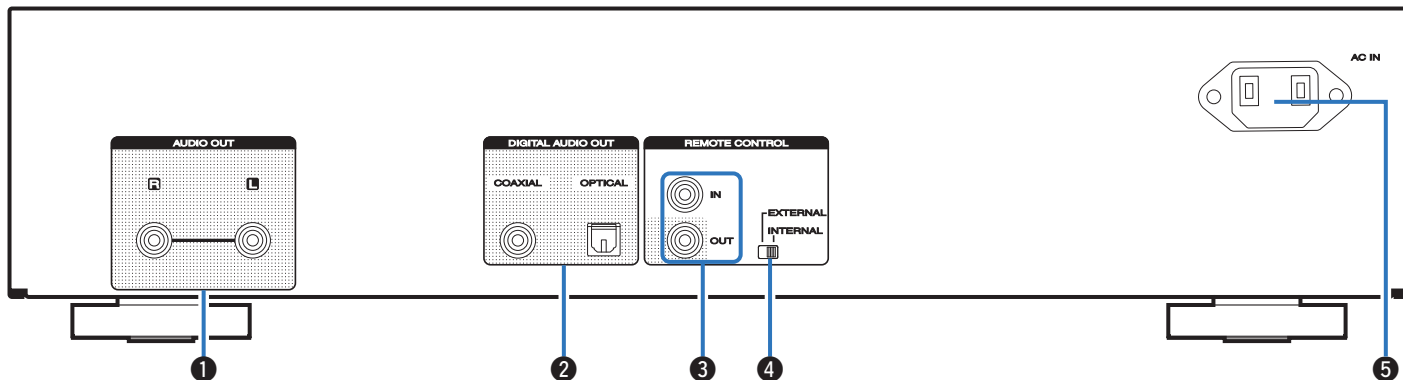

1 AUDIO OUT connectors

Used to connect devices equipped with analog audio inputs connectors or an external power amplifier. (☞ p. 18)

2 DIGITAL AUDIO OUT connectors (COAXIAL/OPTICAL)

Used to connect an AV receiver or D/A converter that has a digital input connectors. (☞ p. 19)

3 REMOTE CONTROL jacks

Used to connect to a Marantz amplifier that is compatible with the remote control function. (☞ p. 20)

4 EXTERNAL/INTERNAL switch

Turn this switch to “EXTERNAL” to operate the unit by pointing the remote control at the amplifier connected to this unit using the remote control connection. (☞ p. 20)

5 AC inlet (AC IN)

Used to connect the power cord. (☞ p. 22)



Remote control unit

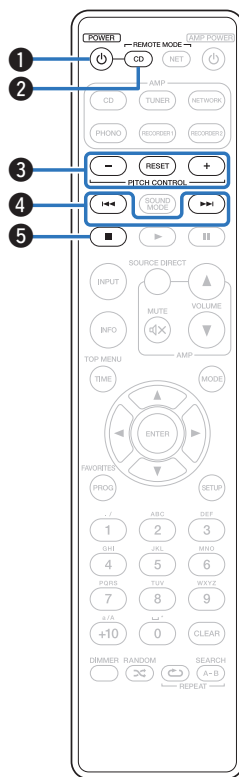

■ Operating this unit

To operate CD player, press REMOTE MODE CD button to switch the remote control to the CD operation mode.

- REMOTE MODE CD button lights for approximately two seconds.

① Power operation button (⏻)

This turns the power on/off (standby).

(☞ p. 24, 38)

② Remote mode select button (REMOTE MODE CD)

This switches the remote control operating mode to CD.

③ Pitch control buttons (PITCH CONTROL -, RESET, +)

This changes the playback speed (pitch) of playback.

(☞ p. 28)

④ Skip buttons (⏮, ⏭)

This skips to the start of the track. Press and hold to fast-forward/fast reverse. (☞ p. 27, 33)

⑤ Stop button (■)

Stops playback. (☞ p. 27, 33)



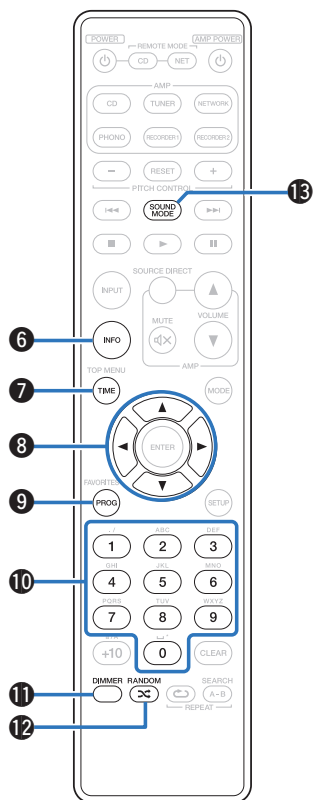

6 Information button (INFO)

This switches the track information shown in the display during playback.

(☞ p. 31, 34, 38)

7 TIME button

This switches the playback time display (track elapsed time, track remaining time and total remaining time).

(☞ p. 27, 33)

8 Cursor buttons (Δ▽◀▶)

These select items. (☞ p. 33, 36)

9 Program button (PROG)

This sets program playback. (☞ p. 29)

10 Number buttons (0 – 9)

These enter letters or numbers into the unit.

(☞ p. 27, 29, 34)

11 DIMMER button

This switches the brightness of the display. (☞ p. 25)

12 RANDOM button (RANDOM ⌘)

Switches the random playback. (☞ p. 27, 33)

13 SOUND MODE button

Switching the sound mode. (☞ p. 25)



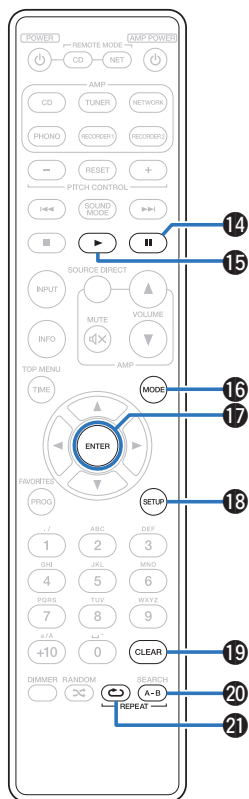

14 Pause button (II)

Pauses playback. (☞ p. 27, 33)

15 Play button (▶)

Playback starts. (☞ p. 27, 33)

16 Playback mode switching button (MODE)

This switches the playback mode. (☞ p. 33)

17 ENTER button

This determines the selection. (☞ p. 33, 36)

18 SETUP button

This displays the setting menu on the display. (☞ p. 36)

19 CLEAR button

This clears the program registration. (☞ p. 30)

20 REPEAT A-B button

This sets A-B repeat playback. (☞ p. 29)

21 REPEAT button (↺)

Switches the repeat playback. (☞ p. 27, 33)



The amp and tuner can be operated with the amp operation buttons even when the remote control mode is CD.



■ Amplifier operations

A Marantz amplifier can be operated.

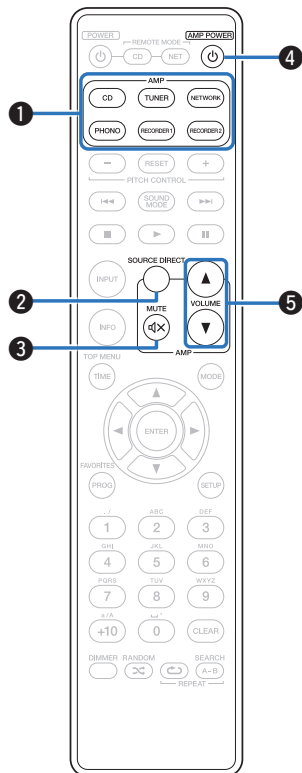

- ① Input source select buttons
- ② SOURCE DIRECT button
- ③ MUTE button (🔇)
- ④ AMP POWER button (🔌)
- ⑤ VOLUME buttons (▲▼)



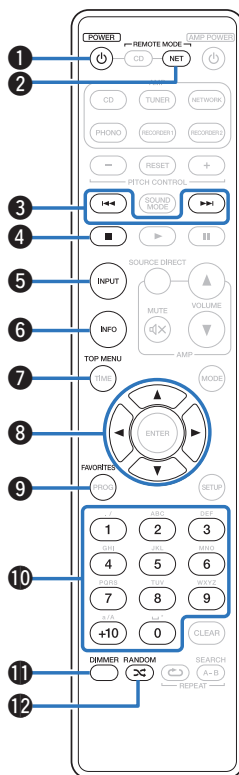

■ Network audio player operations

To operate a Marantz network audio player, press the REMOTE MODE NET button to switch the remote control to the network audio player operation mode.

- REMOTE MODE NET button lights for approximately two seconds.

- 1 Power operation button (⏻)
- 2 Remote mode select button (REMOTE MODE NET)
- 3 Skip buttons (⏮, ⏭)
- 4 Stop button (■)
- 5 Input source select button (INPUT)
- 6 Information button (INFO)
- 7 TOP MENU button
- 8 Cursor buttons (⬆, ⬇, ⬅, ➡)
- 9 FAVORITES button
- 10 Number buttons (0 – 9, +10)
- 11 DIMMER button
- 12 RANDOM button (🎲)



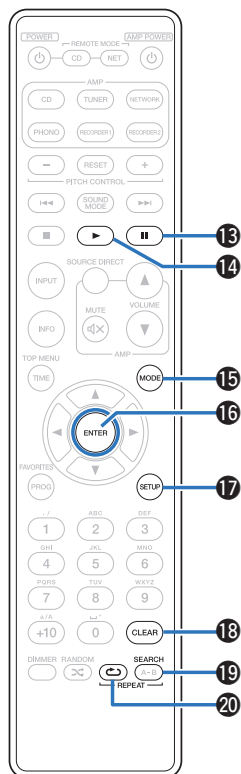

13 Pause button (II)

14 Play button (▶)

15 Playback mode switching button (MODE)

16 ENTER button

17 SETUP button

18 CLEAR button

19 Search button (SEARCH)

20 REPEAT button (↺)



- The amp and tuner can be operated with the amp operation buttons even when the remote control mode is "NET".
- When using it, also refer to the operating instructions of the other devices.



■ Contents





Connecting to a stereo audio amplifier	18
Connecting to a device with digital audio input connectors	19
Connecting devices with remote control connectors	20
Connecting the timer device	21
Connecting the power cord	22

NOTE

- Do not plug in the power cord until all connections have been completed.
- Do not bundle power cords together with connection cables. Doing so can result in noise.

■ Cables used for connections

Provide necessary cables according to the devices you want to connect.

Audio cable (supplied)	
Remote connector cable (supplied)	
Optical cable (Sold separately)	
Coaxial digital cable (Sold separately)	



Connecting to a stereo audio amplifier

Use this connection for audio playback via an amplifier.

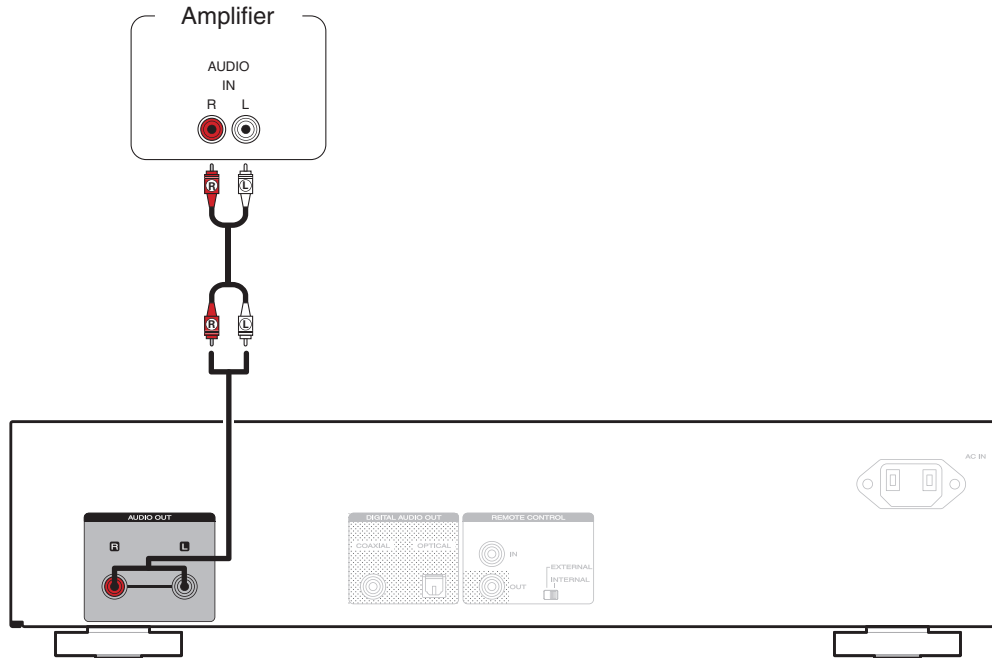

Connecting to a device with digital audio input connectors

You can enjoy digital audio playback by connecting an AV receiver or D/A converter that has a digital audio terminal to this unit.

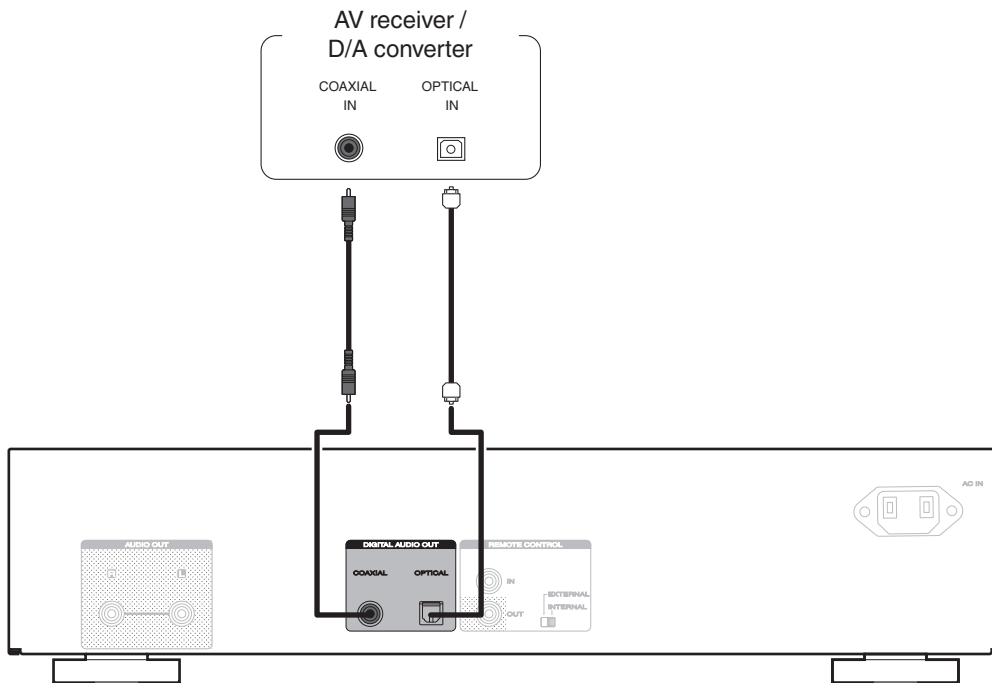

Connecting devices with remote control connectors

When you use this unit connected to a Marantz amplifier, this unit receives operation signals sent from the amplifier and operates accordingly. Next, configure the “Connections” and “Settings”.

Connection

Use the supplied remote connector cable to connect the REMOTE CONTROL IN connector of this unit to REMOTE CONTROL OUT connector of the amplifier.

Setting

Turn the EXTERNAL/INTERNAL switch on the unit to “EXTERNAL”.

- This setting will disable remote sensor reception of this unit.
- To operate the unit, point the remote control at the remote sensor of the amplifier.



To use this unit by itself without connecting an amplifier, turn the switch to “INTERNAL”.

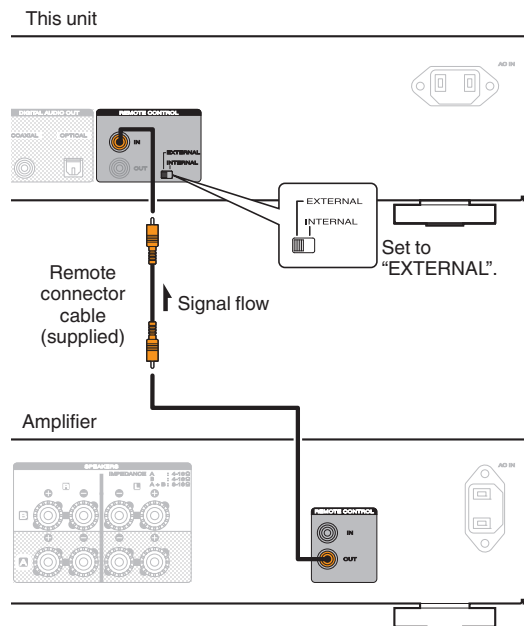

Connecting the timer device

This unit can perform timer play when an amplifier and timer device are connected to this unit.
("Timer Play" (📖 p. 37))

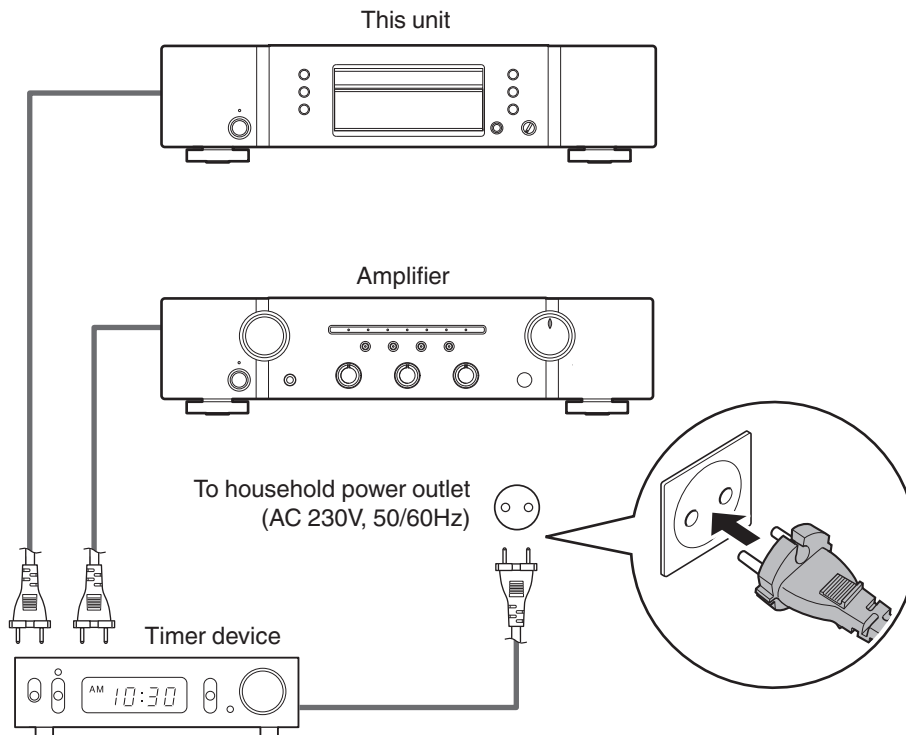

Connecting the power cord

After completing all the connections, insert the power plug into the power outlet.

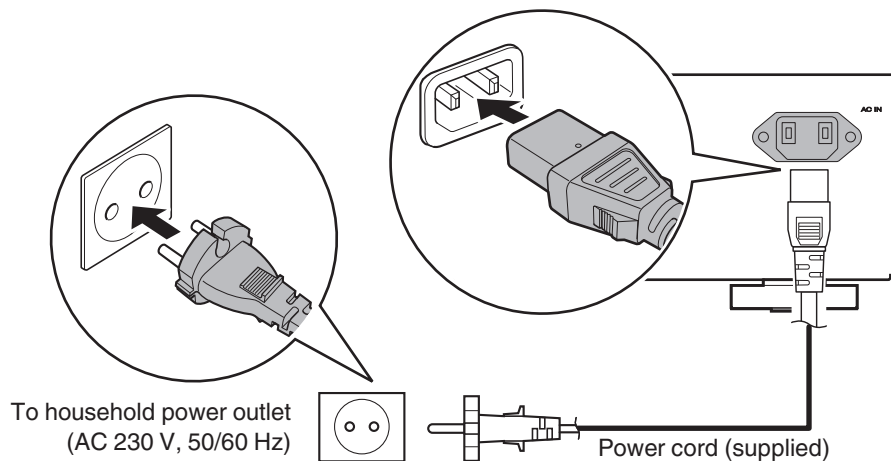

■ Contents

Basic operation	24
Playing CDs	26
Playing DATA CDs (MP3 and WMA files)	32



Basic operation

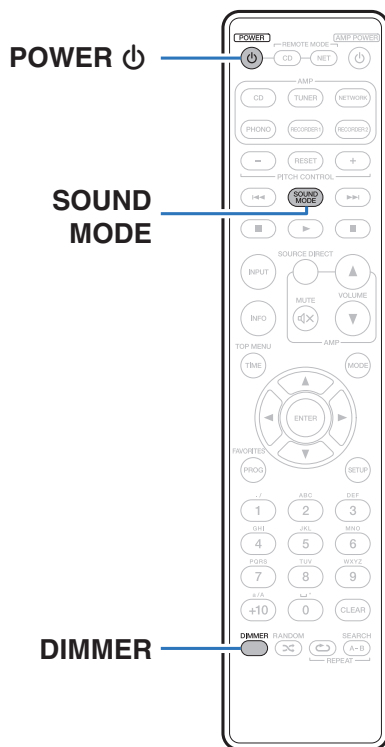

Turning the power on

- 1 Press **POWER**  to turn on power to the unit.
The power indicator turns off.



You can also switch the power to standby by pressing  on the main unit.

■ When power is switched to standby

- 1 Press **POWER** .
- The unit switches to standby mode, and the Power indicator lights red.



Switching the display's brightness

The brightness of the display can be adjusted to one of four levels.

1 Press DIMMER.

Switching the sound mode

This function turns the unit display and digital output off to playback higher sound quality from the audio signal.

1 In the stop mode, press SOUND MODE.

Audio EX OFF (Default):

Audio EX mode is not set.

- Pitch control : Enable
- Digital output : Yes
- Display : Yes

Audio EX 1 : Audio EX 1 offers better sound.

- Pitch control : Disable
- Digital output : No
- Display : Yes

Audio EX 2 : Audio EX 2 offers best sound from analog outputs.

- Pitch control : Disable
 - Digital output : No
 - Display : No (during play)
-



If DIMMER is pressed when the sound mode is "Audio EX 2", the display is shown for approximately 3 seconds.



Playing CDs

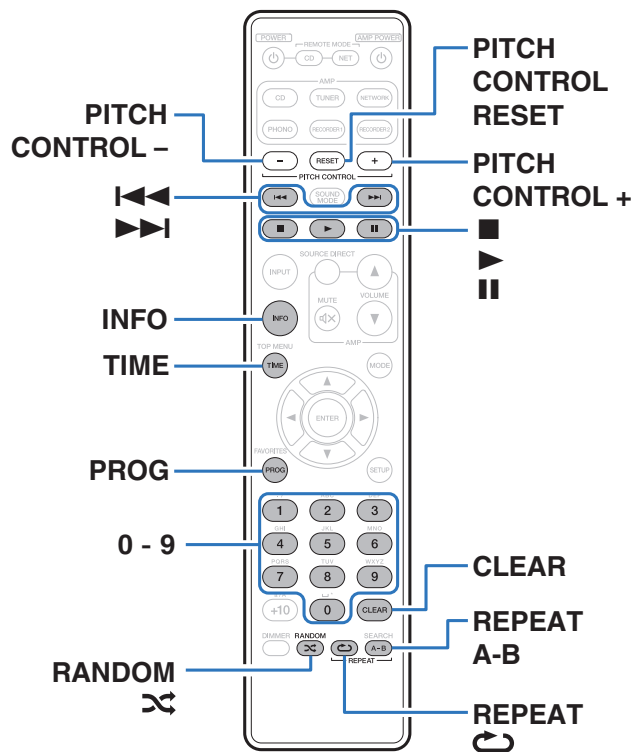







Playing CDs

- 1 Insert a disc.** (See p. 47)
 - Press **▲** on the unit to open/close the disc tray.
- 2 Press ▶.**
 - The ▶ indicator lights on the display. Playback starts.

NOTE

- Do not place any foreign objects in the disc tray. Doing so could damage the set.
- Do not push the disc tray in by hand when the power is turned off. Doing so could damage the set.



Operation buttons	Function
	Playback
	Pause
	Stop
	Skip to previous track / Skip to next track (Press and hold) Fast-reverse / Fast-forward
0 – 9	Select the track
RANDOM 	Random playback
REPEAT 	Repeat playback <ul style="list-style-type: none"> Switching between All-track repeat and Single-track repeat.
REPEAT A-B	A-B repeat playback ( p. 29)
TIME	Time display switching <ul style="list-style-type: none"> Track elapsed time, Track remaining time and Total remaining time

■ Playing a specific track (Direct searching)

1 Use 0 – 9 to select the tracks.

[Example]

Track 4 :

Press number 4 to select track 4.

Track 12 :

Press numbers 1 and 2 consecutively to select track 12.



The number you enter is set about 1.5 seconds after you press the number buttons. To enter a two-digit number, be sure to press the two number buttons, one immediately after the other.



Changing the playback speed (Pitch control playback)

This changes the playback speed (pitch) of playback during playback of a music CD (CD-DA).

■ Increasing the playback speed

1 Press PITCH CONTROL +.

- The "PITCH" indicator appears in the display, and the playback speed becomes faster (increases) each time the button is pressed (until the maximum +12).

■ Decreasing the playback speed

1 Press PITCH CONTROL -.

- The "PITCH" indicator appears on the display, and the playback speed becomes slower (decreases) each time the button is pressed (until the minimum -12).

■ Returning to normal playback speed

1 Press PITCH CONTROL RESET.

- The "PITCH" indicator disappears from the display, and "Pitch:0" appears in the display.
- Press PITCH CONTROL RESET again to switch back to the previously set playback speed.

NOTE

- The pitch control function is only enabled when the Audio EX setting is set to "Audio EX OFF". (🔍 p. 25)
- Pitch control playback cannot be used for MP3 and WMA files.



A-B repeat playback

You can specify the section within a track that you want to hear, and play it back repeatedly.

1 During playback, press REPEAT A-B at the point where you want to start playing repeatedly.

“Repeat A-” is displayed on the display.

2 Press REPEAT A-B at the point where you want to stop playing repeatedly.

“Repeat A-B” is displayed on the display, and the specified section (point A to point B) is played back repeatedly.

■ To cancel A-B repeat playback

Press REPEAT A-B.



A-B repeat playback cannot be used during random playback.

Playing tracks in a specific order (Program playback)

Up to 25 tracks can be programmed.

1 In the stop mode, press PROG.

“Program” is displayed on the display.

2 Use 0 – 9 to select the tracks.

[Example]

Track 4 : Press number 4 to select track 4.



Track 12 : Press numbers 1 and 2 consecutively to select track 12.

- The number you enter is set about 1.5 seconds after you press the number buttons. To enter a two-digit number, be sure to press the two number buttons, one immediately after the other.

3 Press ►.

Playback starts in the programmed order.



- When RANDOM  is pressed during program playback, the programmed tracks are played in random order.
- When REPEAT  is pressed during program playback, the tracks are played repeatedly in the programmed order.

NOTE

The program is cleared when the disc tray is opened or the power is turned off.



■ Checking the order of the programmed tracks

In the stop mode, press ►►I.

The tracks are shown in the programmed order in the display each time ►►I is pressed.

■ To clear the last track programmed

In the stop mode, press CLEAR.

To clear the last track programmed.

The last track programmed is cleared each time the button is pressed.

■ Clearing the all programmed track

In the stop mode, press PROG.

Skipping tracks you don't want to hear (Delete program playback)

A maximum of 25 tracks can be programmed for delete program playback.

1 During stop mode, press PROG, and then press CLEAR.

“Delete Program” is displayed on the display.

2 Use 0 – 9 to select the tracks you want to skip.

[Example]

If you want to skip the 3rd and 12th tracks, press 3 and then press 1 and 2.

3 Press ►.

Playback starts, and the selected tracks are skipped.

■ Checking details of the delete program

In the stop mode, press ►►I.

The skipped tracks are shown in order in the display each time ►►I is pressed.



■ To clear the last delete program track

In the stop mode, press CLEAR.

The last track in the delete program is cleared.

The last track set in the delete program is cleared in order each time CLEAR is pressed.

■ Clearing the all delete program tracks

In the stop mode, press PROG.

Switching the display (CD-TEXT)

- You can view text information stored on a disc as CD-TEXT on this unit. Mainly, information on the current track being played is displayed.
- A maximum of 32 characters can be displayed.
- Only English text is supported.

1 During playback, press INFO.

Switching between the title name, artist name and album name.



You can set which information is displayed first when INFO is pressed.

For details on the settings, see “Display Info” ( p. 38).

NOTE

As the stored information differs depending on the disc, all of the information may not be displayed.



Playing DATA CDs (MP3 and WMA files)

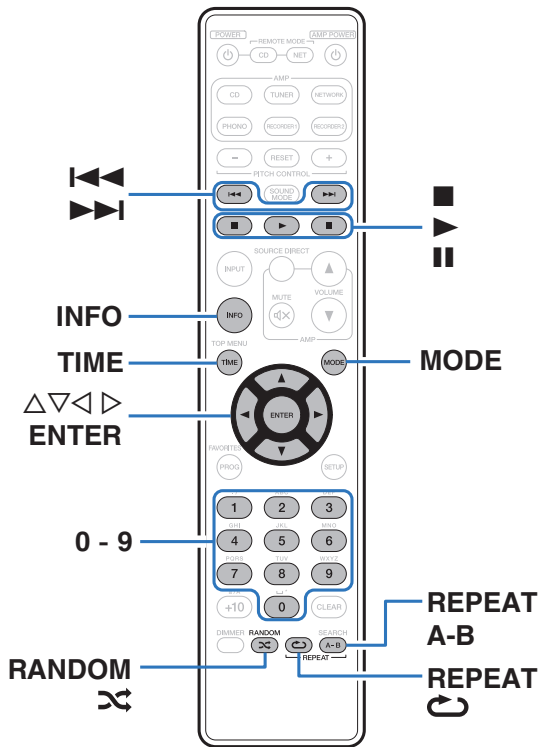

- This section explains how to playback MP3 and WMA files that are recorded onto a CD-R or CD-RW. For details on how to playback files recorded onto media other than CD-R or CD-RW, see the following sections.
- There are many music distribution sites on the Internet allowing you to download music files in MP3 or WMA (Windows Media® Audio) format. The music (files) downloaded from such sites can be stored on CD-R or CD-RW discs and played on this unit.

“Windows Media” and “Windows” are the trademarks or registered trademarks of Microsoft Corporation in the United States and other countries.



Playing files

1 Load a CD-R or CD-RW disc containing music files in the MP3 or WMA formats into the disc tray.

( p. 47)

- Press  on the unit to open/close the disc tray.

2 Press MODE to select the folder mode or all mode.

About the display









- When “Folder mode” is selected
“FLD” indicator lights.
All the files in the selected folder are played.
- When “All mode” is selected
“FLD” indicator turns off.
After the selected folder and files are played, all the files in all the folders are played.

3 Use to select the folder to be played.

4 Use to select the file to be played.

5 Press .

Playback starts.

Operation buttons	Function
	Playback
	Pause
	Stop
	Skip to previous track / Skip to next track (Press and hold) Fast-reverse / Fast-forward
	Folder select
	File select
0 – 9	Select the track
MODE	Switch to Folder playback mode <ul style="list-style-type: none"> • All the files in the selected folder are played.
RANDOM 	Random playback
REPEAT 	Repeat playback <ul style="list-style-type: none"> • Switching between All-track repeat and Single-track repeat.
REPEAT A-B	A-B repeat playback ( p. 29)
TIME	Time display switching <ul style="list-style-type: none"> • Display switches between the track elapsed time and total remaining time.



The folder and file numbers are set automatically when the disc is loaded.



NOTE

- Programmed playback is not possible with MP3/WMA discs.
- Copyright-protected files cannot be played.

(The “Not Support” is displayed.)

Note that depending on the software used for burning and other conditions, some files may not play or display correctly.

■ Playable files (Extension) (🔑 p. 44)

■ To switch the folder or file during playback

- Folder
Use $\Delta \nabla$ to select the folder, then press ENTER.
- Files
Use $\triangleleft \triangleright$ to select the file, then press ENTER.
Also use $\blacktriangleleft \blacktriangleright$ to select the file, or use 0 – 9 to select the file number.
- The file numbers are set automatically when the disc is loaded.

■ Switching the display

During playback, press INFO.

- Switching between the file name, title name, artist name and album name.
- The player can display the following characters:

```

ABCDEFGHIJKLMNPOQRSTUVWXYZ
abcdefghijklmnopqrstuvwxyz
0123456789
!"#$%&:;<?@\[_`|{~^'(*+,-./= (space)

```



Menu map

By default, this unit has recommended settings defined. You can customize this unit based on your existing system and your preferences.

Setting items	Description	Page
Digital Out	Setting the digital audio output signal.	37
Timer Play	This unit can perform timer play by cooperating with your timer device.	37
Display Info	Sets the information displayed during playback of CD-TEXT Disc, MP3 and WMA files.	38
Auto Standby	Sets whether to automatically switch the unit to the standby mode when the unit remains in the stop mode for more than 30 minutes.	38



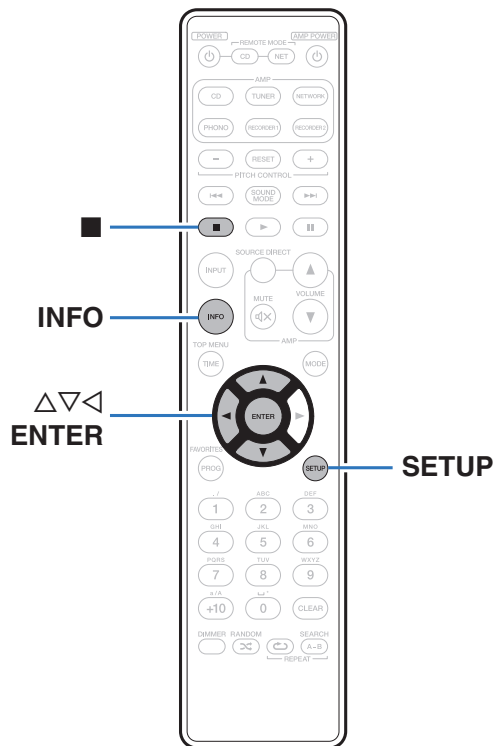

Menu operation

- 1 Press SETUP while playback is stopped.**
The menu is displayed on the display.
- 2 Use Δ / ∇ to select the menu to be set or operated, then press ENTER.**
- 3 Use Δ / ∇ to change to desired setting.**
- 4 Press ENTER to enter the setting.**
 - To return to the previous item, press \triangleleft .
 - Exiting the Menu, press SETUP while the menu is displayed.
The display returns to the normal display.



Digital Out

Switched the digital audio output on/off.

On (Default):	Use the digital audio output connector.
Off:	Do not use the digital audio output connector.

Timer Play

This unit can perform timer play by cooperating with your timer device. ("Connecting the timer device" (🔗 p. 21))

On:	Timer play is set.
Off (Default):	Timer play is not set.

■ Using the timer play function

1. Turn on the power of the connected components.
2. Insert a disc.
3. Switch the amplifier's function to input from the connected unit.
4. Set the audio timer for the desired times.
5. Turn the timer on.
6. The power of the components connected to the timer turns off.
When the set time is reached, the power of the different components automatically turns on and playback starts from the first track.

NOTE

The timer play does not support the random play or program play.



Display Info

Sets the information displayed during playback of CD-TEXT Disc, MP3 and WMA files.

File Name (Default):	Displays the file name.
Title:	Displays the title name.
Artist:	Displays the artist name.
Album:	Displays the album name.



Press INFO to switch the information during playback.

Auto Standby

Sets whether to automatically switch the unit to the standby mode when the unit remains in the stop mode for more than 30 minutes.

On (Default):	Enable Auto Standby mode.
Off:	Disable Auto Standby mode.



■ Contents

Tips

I want to enjoy analog output audio at higher quality	40
I want to display CD-TEXT	40
I want to skip tracks on a CD	40
I want to repeatedly listen to a specific section	40
I want to playback just the specified folder	40
I want to change the playback speed of a CD	40
I want to use this unit's remote control to operate a Marantz network audio player	40

Troubleshooting

Power does not turn on / Power is turned off	41
Operations cannot be performed through the remote control unit	42
Display on this unit shows nothing	42
No sound comes out	43
Cannot playback CDs	43



Tips

I want to enjoy analog output audio at higher quality

- Set Audio EX which turns digital output and the display off. (🔗 p. 26)

I want to display CD-TEXT

- This unit is compatible with CD-TEXT. Press the INFO button to switch the displayed information. (🔗 p. 31)

I want to skip tracks on a CD

- Select the tracks that you want to skip in delete program playback mode. (🔗 p. 30)

I want to repeatedly listen to a specific section

- Set A-B repeat playback. (🔗 p. 29)

I want to playback just the specified folder

- The MODE button to set the playback range to "Folder mode". (🔗 p. 33)

I want to change the playback speed of a CD

- This unit is equipped with a pitch control function. Press the PITCH CONTROL + or - button on the remote control unit to change the playback speed. (🔗 p. 28)

I want to use this unit's remote control to operate a Marantz network audio player

- Press the REMOTE MODE NET button on the remote control unit to switch the remote control unit to the network audio player operation mode. (🔗 p. 15)
- Also, refer to the instruction manual of the network audio player.



Troubleshooting



If a problem should arise, first check the following.

1. **Are the connections correct?**
2. **Is the set being operated as described in the owner's manual?**
3. **Are the other devices operating properly?**

If this unit does not operate properly, check the items listed in the table below.

Should the problem persist, there may be a malfunction. In this case, disconnect the power immediately and contact your store of purchase.

■ Power does not turn on / Power is turned off

Symptom	Cause / Solution	Page
Power is not turned on.	• Check whether the power plug is correctly inserted into the power outlet.	<u>22</u>
	• This unit is in standby mode. Press the  button on the unit or POWER  button on the remote control.	<u>24</u>
Power automatically turns off.	• The Auto Standby mode is set. The Auto Standby mode switches the unit to standby mode when the unit is not operated for approximately 30 minutes. To disable Auto Standby mode, set "Auto Standby" on the menu to "Off".	<u>38</u>



■ Operations cannot be performed through the remote control unit

Symptom	Cause / Solution	Page
Operations cannot be performed through the remote control unit.	• Batteries are worn out. Replace with new batteries.	5
	• Operate the remote control unit within a distance of about 7 m from this unit and at an angle of within 30°.	5
	• Remove any obstacle between this unit and the remote control unit.	—
	• Insert the batteries in the proper direction, checking the ⊕ and ⊖ marks.	5
	• The set's remote control sensor is exposed to strong light (direct sunlight, inverter type fluorescent bulb light, etc.). Move the set to a place in which the remote control sensor will not be exposed to strong light.	—
	• When using a 3D video device, the remote control unit of this unit may not function due to effects of infrared communications between units (such as TV and glasses for 3D viewing). In this case, adjust the direction of units with the 3D communications function and their distance to ensure they do not affect operations from the remote control unit of this unit.	—
	• Press the REMOTE MODE CD button to switch the remote control operating mode to "CD".	11
• When using this unit independently, set the switch to "INTERNAL".	20	

■ Display on this unit shows nothing

Symptom	Cause / Solution	Page
Display is off.	• Press the DIMMER button, and change the setting to anything other than off.	25
	• The display is switched off when the sound mode is set to "Audio EX 2".	25



■ No sound comes out

Symptom	Cause / Solution	Page
No sound is produced. Or sound is distorted.	• Check the connections for all devices.	17
	• Insert connection cables all the way in.	—
	• Check that input connectors and output connectors are not reversely connected.	—
	• Check cables for damage.	—
	• Check the amplifier's functions and controls and adjust as necessary.	—



■ Cannot playback CDs

Symptom	Cause / Solution	Page
Cannot playback when the play button is pressed, or cannot correctly play back a specific part of the disc.	• The CD is dirty or scratched. Either clean the CD, or insert a different CD.	48
Cannot playback CD-R/CD-RW.	• CDs cannot be played back unless they have been finalized. Use a finalized disc.	44
	• This may be caused by poor recording conditions, or the disc itself may be of poor quality. Use a correctly recorded disc.	—
	• The DATA CD playback function of this unit only supports playback of MP3 and WMA files.	44
"No Disc" is displayed.	• "No Disc" is displayed if the disc is loaded upside-down or if no disc is loaded.	47
"00Tr 00:00" is displayed.	• "00Tr 00:00" is displayed if a disc that cannot be played is loaded.	47



Playable media

Discs

Playable media	
CD	
CD-R	
CD-RW	

NOTE

- Some discs and some recording formats may not be playable.
- Non-finalized discs cannot be played.

Files

CD-R and CD-RW discs created in the format described below can be played.

■ Writing software format

ISO9660 level 1, 2

Expansion format (Juliet.Romeo)

■ When written in other formats, it may not be possible to play the disc properly.

Maximum number of playable files and folders

Number of folders : 255

Number of files : 255

■ Tag data

ID3-TAG (Ver.1.x and 2.x)

WMA-TAG

(The title, artist, and album tag data are supported)



Playable files (Extension)	File specification
MP3 (.mp3)	• Sampling frequency : 32 / 44.1 / 48 kHz
	• Bit rate : 32 kbps to 320 kbps
	• File format : MPEG1 Audio Layer 3
WMA (.wma)	• Sampling frequency : 32 / 44.1 / 48 kHz
	• Bit rate : 64 kbps to 192 kbps
	• File format : Windows Media Audio

NOTE

- Be sure to give files the extension “.mp3” or “.wma”. Files with any other extensions or files with no extensions cannot be played.
- Recordings you have made should only be used for your personal enjoyment, and as per copyright laws may not be used in other ways without permission of the copyright holder.

Playback order of MP3/WMA files

When there are multiple folders containing MP3/WMA files, the playback order of folders is automatically set when this unit reads the media. The files in each folder are played back in the order in which the files were recorded on the media, from the oldest date and time.

CD-R/CD-RW

For playback of files on CD-R or CD-RW, files in all folders on the first layer are played first, next on the second layer, then next on the third layer, and so on in this order.



- The playback order displayed on a PC may differ from the actual playback order.
- The playback order with a CD-R/CD-RW may differ, depending on the writing software.



About discs and files

Files, such as MP3/WMA etc., recorded on CD-R/-RW are divided into large segments (folders) and small segments (files). Files are stored in folders, and folders can be placed for storage in a hierarchy. The unit can recognize up to 8 levels of folders.

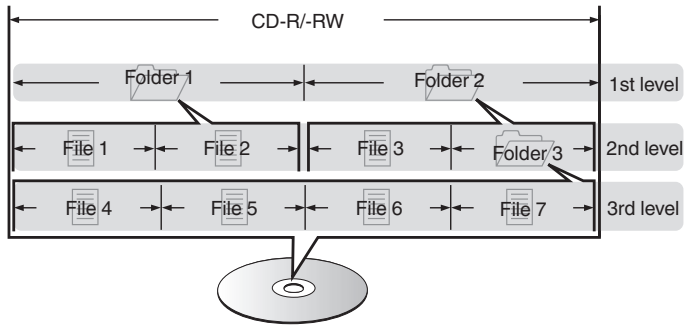

- When writing MP3/WMA etc. files on a CD-R/-RW disc, set the writing software's format to "ISO9660". The files may not play properly if they are recorded in other formats. For details, refer to the instructions of your writing software.



Cautions on using media

Inserting a disc

- Set the disc in the tray label side up.
- Make sure the disc tray is fully open when inserting the disc.
- Place the discs flatly, 12 cm discs in the outer tray guide (Figure 1), 8 cm discs in the inner tray guide (Figure 2).

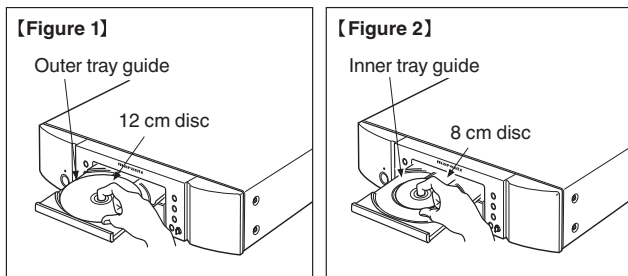

- Place 8 cm discs in the inner tray guide without using an adapter.



- "00Tr 00:00" is displayed if a disc that cannot be played is loaded.
- "No Disc" is displayed if the disc is loaded upside-down or if no disc is loaded.

NOTE

- Only load one disc at a time. Loading two or more discs can damage the unit or scratch the discs.
- Do not use cracked or warped discs or discs that have been repaired with adhesive, etc.
- Do not use discs on which the sticky part of cellophane tape or labels is exposed or on which there are traces of where labels have been removed. Such discs can get caught inside the player and damage it.
- Do not use discs in special shapes, as they may damage the player.



- Do not push the disc tray in by hand when the power is off. Doing so could damage the set.
- If the unit is left in a room full of smoke from cigarettes, etc., for long periods of time, the surface of the optical pickup may get dirty, preventing it from receiving signals properly.



How to handle media

- Do not get fingerprints, oil or dirt on discs.
- Take special care not to scratch discs when removing them from their cases.
- Do not bend or heat discs.
- Do not enlarge the hole in the center.
- Do not write on the labeled (printed) surface with ball-point pens, pencils, etc., or stick new labels on discs.
- Condensation may form on discs if they are moved suddenly from a cold place (outdoors for example) to a warm place, but do not try to dry discs with a hairdryer, etc.
- Do not store discs in the following places:
 1. Places exposed to direct sunlight for long periods of time
 2. Dusty or humid places
 3. Places exposed to heat from heaters, etc.

Cleaning discs

- If there are fingerprints or dirt on a disc, wipe them off before using the disc.
- Use a commercially available disc cleaning set or a soft cloth to clean discs.



Gently wipe the disc from the inside towards the outside.

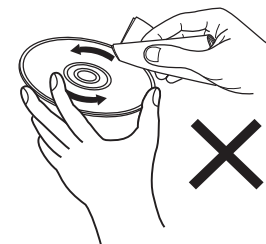

Do not wipe with a circular motion.

NOTE

Do not use record spray, antistatic agents, benzene, thinner or other solvents.



Explanation of terms

MP3 (MPEG Audio Layer-3)

This is an internationally standardized audio data compression scheme, using the “MPEG-1” video compression standard. It compresses the data volume to about one eleventh its original size while maintaining sound quality equivalent to a music CD.

WMA (Windows Media Audio)

This is audio compression technology developed by Microsoft Corporation.

WMA data can be encoded using Windows Media® Player.

To encode WMA files, only use applications authorized by Microsoft Corporation. If you use an unauthorized application, the file may not work properly.

Sampling frequency

Sampling involves taking a reading of a sound wave (analog signal) at regular intervals and expressing the height of the wave at each reading in digitized format (producing a digital signal).

The number of readings taken in one second is called the “sampling frequency”. The larger the value, the closer the reproduced sound is to the original.

Dynamic range

The difference between the maximum undistorted sound level and the minimum discernible level above the noise emitted by the device.

Bit rate

This is the amount of audio data recorded on a disc that is read in one second.

Finalizing

This process enables CDs recorded with a CD recorder or drive to be played by other players.

Linear PCM

This is an uncompressed PCM (Pulse Code Modulation) signal. Unlike lossy compression audio sources such as MP3, no audio quality or dynamic range deteriorates.



Specifications

■ Audio performance

• Analog output

Channels:	2-channels
Playable frequency range:	2 Hz – 20 kHz
Playable frequency response:	2 Hz – 20 kHz (± 0.5 dB)
S/N:	110 dB
Dynamic range:	100 dB
Harmonic distortion:	0.002 % (1 kHz)
Wow & flutter:	Crystal accuracy

• Output level

Signal type:	2.35 V RMS stereo
Headphone output:	28 mW/32 Ω /ohms (variable maximum)

• Digital output

Coaxial:	0.5 V _{p-p} / 75 Ω /ohms
Optical :	-19 dBm

• Optical readout system

Laser:	AlGaAs
Wave length:	780 nm
Signal type:	16-bit linear PCM
Sampling frequency:	44.1 kHz



■ General

Power supply:	AC 230 V, 50/60 Hz
Power consumption:	14 W
Power consumption in standby mode:	0.35 W or less
Operating temperatures:	+5 °C - +35 °C
Operating humidity:	5 – 90 % (without dew)

For the purpose of improvement, the specifications and design are subject to change without notice.



■ Dimensions (Unit : mm)

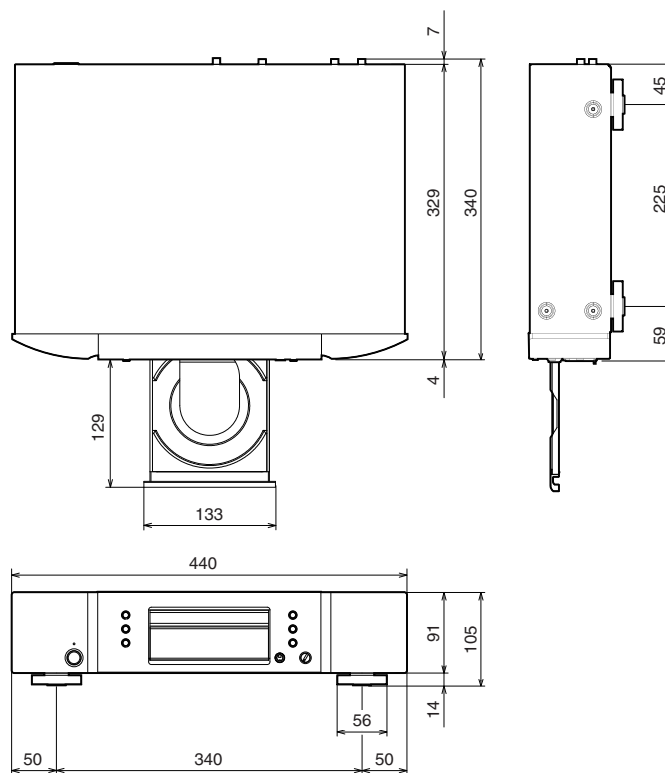

■ Weight : 5.0 kg

Index

A		D		P	
A-B repeat playback	29	D/A converter connections	19	Pitch control playback	28
Accessories	4	DATA CD playback	32	Program playback	29
Amplifier connections	18	Delete program playback	30	R	
Audio EX	25	Display	9	Random playback	27, 33
Auto Standby	38	Display brightness	25	Rear panel	10
AV receiver connections	19	Dynamic range	49	Remote control	20
B		F		Remote control unit	11
Bit rate	49	Finalizing	49	Repeat playback	27, 33
C		Front panel	7	S	
Cables used for connections	17	I		Sampling frequency	45, 49
CD playback	26	Inserting the batteries	5	Select the track	27
CD-TEXT	31	L		T	
Connecting a power cord	22	Linear PCM	49	Timer device	21
		M		Tips	40
		Menu map	35	Troubleshooting	41
		MP3 file playback	32	Turning the power on	24
				W	
				WMA file playback	32



www.marantz.com

You can find your nearest authorized distributor or dealer on our website.

marantz[®] is a registered trademark.

D&M Holdings Inc.
3520 10329 00AM