

marantz

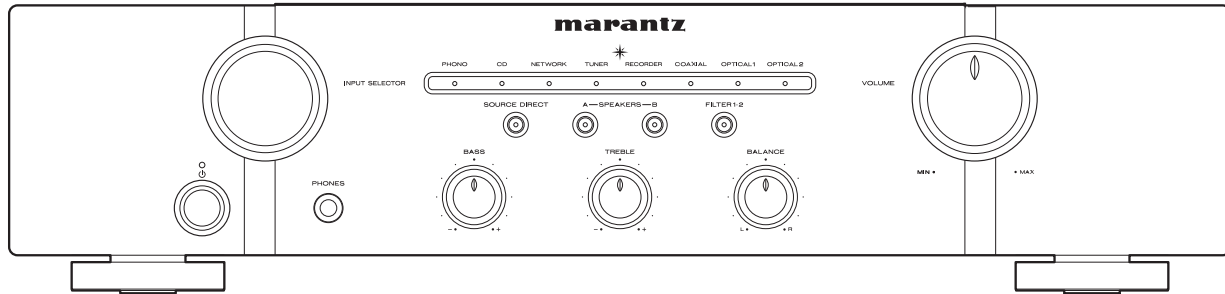

PM6007 | Integrated Amplifier

QUICK START GUIDE

Welcome

Thank you for choosing a Marantz amplifier. This guide provides step-by-step instructions for setting up your amplifier.

Before You Begin

What's In the Box

Quick Start Guide

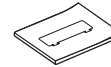

Amplifier

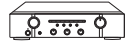

Owner's Manual



Power cord



Safety Instructions



Remote control unit (RC004PMCD)



Warranty (for USA/ for CANADA)



R03/AAA batteries



Required for Setup

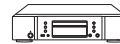

CD Player



Speaker systems



Speaker cables



These drawings are for illustrative purposes only and may not represent the actual product(s).

Setup

There are six steps to the setup process.

- 1 Install batteries in the remote control unit
- 2 Connect the speakers to PM6007
- 3 Connect the CD player to PM6007
- 4 Plug the power cord into a power outlet
- 5 Turn on the power of PM6007 and then set the speakers for audio output to SPEAKERS A
- 6 Begin CD playback

1 Install batteries in the remote control unit

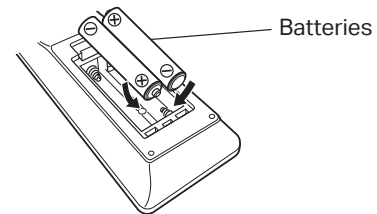
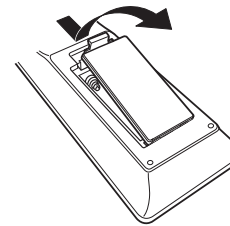

2 Connect the speakers to PM6007

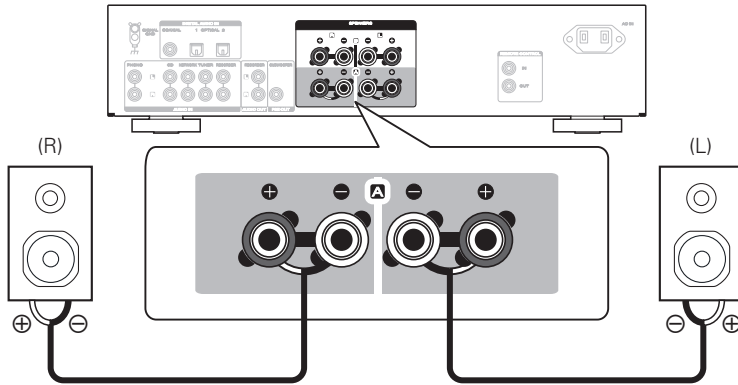

Connecting the speaker cables

① Peel off about 3/8 inch (10 mm) of sheathing from the tip of the speaker cable, then either twist the core wire tightly or apply solder to it.



② Turn the speaker terminal counterclockwise to loosen it.



③ Insert the speaker cable's core wire to all the way into the speaker terminal.



④ Turn the speaker terminal clockwise to tighten it.



3 Connect the CD player to PM6007

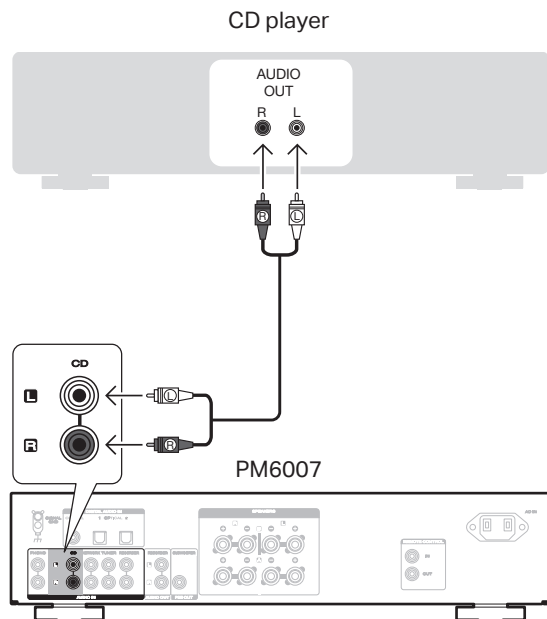

4 Plug the power cord into a power outlet

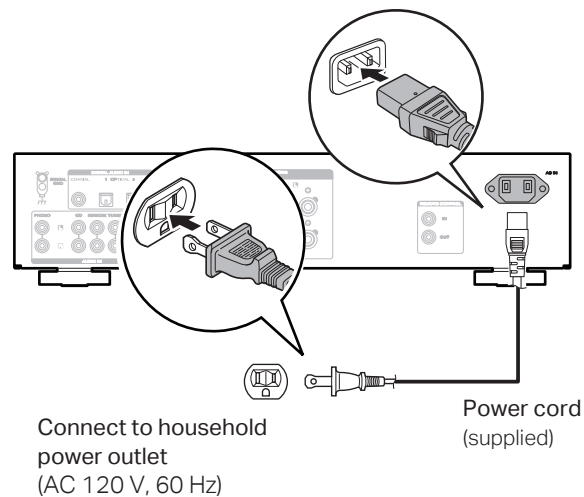

5 Turn on the power of PM6007 and then set the speakers for audio output to **SPEAKERS A**

- 1 Reduce the volume to the minimum level.

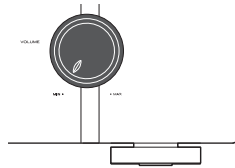

- 2 Press the power operation button.

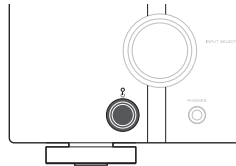

- 3 Press **SPEAKERS A**. The **SPEAKERS A** indicator lights and the speakers for audio output are set to **SPEAKERS A**.

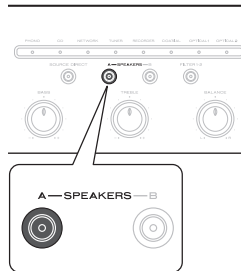

6 Begin CD playback

- 1 Set the input source to "CD".

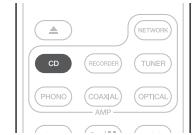

- 2 Play the CD player.

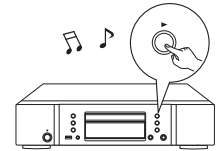

- 3 Adjust the volume.

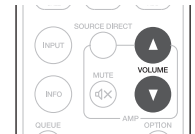

Owner's Manual

- Refer to the Online Manual for other functions information and operation procedure details.

manuals.marantz.com/PM6007/NA/EN/



Online Manual

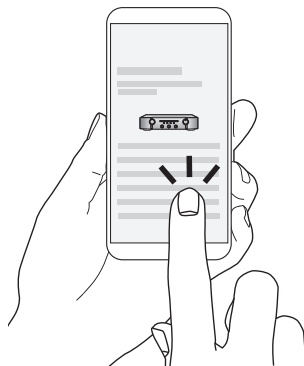

- For more information, visit www.marantz.com

www.marantz.com

You can find your nearest authorized distributor or dealer on our website.

marantz is a registered trademark.